

GENERAL CONTRACT OF USE FOR WAGONS

GCU

**Edition dated
1 January 2022**

CONTENTS

PREAMBLE

CHAPTER I - OBJECT, SCOPE OF APPLICATION, TERMINATION, FURTHER DEVELOPMENT OF THE CONTRACT, DISCONTINUANCE OF BEING A SIGNATORY

Article 1	Object
Article 2	Scope of application
Article 3	Termination
Article 4	Further development of the contract
Article 5	Discontinuance of being a signatory
Article 6	In abeyance

CHAPTER II - OBLIGATIONS AND RIGHTS OF THE WAGON KEEPER

Article 7	Technical admission and maintenance of wagons
Article 8	Inscriptions and signs on the wagon. Identification of wagons
Article 9	Keeper's right of deployment

CHAPTER III - OBLIGATIONS AND RIGHTS OF THE RUs

Article 10	Acceptance of wagons
Article 11	Refusal of wagons
Article 12	Handling of wagons
Article 13	Wagon periods for carriage and liability
Article 14	Deployment of empty wagons
Article 15	Information to be supplied to the keeper
Article 16	Handover of a wagon to third parties
Article 17	Acceptance of a wagon from third party keepers

CHAPTER IV - ASCERTAINMENT AND HANDLING OF DAMAGE TO WAGONS IN THE CUSTODY OF AN RU

Article 18	Ascertainment of damage
Article 19	Handling of damage
Article 20	Handling of lost wagons and removable accessories
Article 21	Handling of bogies

CHAPTER V - LIABILITY IN THE EVENT OF LOSS OR OF DAMAGE TO A WAGON

Article 22	Liability of the user RU
Article 23	Amount of compensation
Article 24	Liability of previous users
Article 25	Obligation to mitigate losses
Article 26	Settlement of damages

CHAPTER VI - LIABILITY IN THE EVENT OF DAMAGE CAUSED BY A WAGON

Article 27	Principle of liability
------------	------------------------

CHAPTER VII - LIABILITY FOR STAFF AND OTHER PERSONS

Article 28	Principle of liability
------------	------------------------

CHAPTER VIII - OTHER PROVISIONS

Article 29	Loading guidelines
Article 30	Accountancy and payment
Article 31	Obligation to pay damages
Article 32	Competent jurisdiction
Article 33	Limitation
Article 34	Languages
Article 35	Entry into force

APPENDICES

Appendix 1	List of signatory keepers and RUs
Appendix 2	Definitions
Appendix 3	Documents relating to the conveyance of empty wagons.
Appendix 4	Wagon damage report .
Appendix 5	Calculating compensation for a wagon or bogie in the event of loss or damage
Appendix 6	Compensation for loss of use
Appendix 7	Spare parts
Appendix 8	Internal Regulation for the Application and Further Development of the GCU
Appendix 9	Conditions for the technical transfer inspection of wagons
Appendix 10	Corrective and preventive maintenance
Appendix 11	Inscriptions and signs on wagons
Appendix 12	Catalogue of damage to wagons
Appendix 13	List of repairs which may be carried out by the RU on the place of immobilization of the wagon or in the nearby vicinity.
Appendix 14	Additional conditions for the use of wagons on ferries and in exchange with railways operating on standard or broad gauge lines
Appendix 15	Wagon Performance Message (WPM)
Appendix 16	Wagon Vehicle Data

PREAMBLE

The use of wagons by railway undertakings (RU)¹ as a means of transport necessitates the adoption of contractual provisions setting out the rights and obligations of each party.

In order to ensure the safety and to improve the efficiency and competitiveness of railway freight traffic, the wagon keepers and RUs listed in Appendix 1 hereby agree to apply the provisions of this

¹ Terms marked with an asterisk (*) are explained in Appendix 2 (Definitions)

CHAPTER I

OBJECT, SCOPE OF APPLICATION, TERMINATION, FURTHER DEVELOPMENT OF THE CONTRACT, DICONTINUANCE OF BEING A SIGNATORY

Article 1: Object

1.1 This contract, including its appendices, sets out the conditions for the provision of wagons for use as a means of transport by RUs in national and international traffic within the scope of application of the COTIF in force.

Commercial conditions for the use of wagons are outside the scope of this contract.

1.2 The provisions of this contract shall apply to wagon keepers and RUs* as users of wagons.

1.3 Use of a wagon includes the loaded run and the empty run, as well as cases in which the wagon is in the custody of a signatory RU.

1.4 Use and custody begin when the wagon is accepted by the RU and end with the handover of the wagon to the keeper or to some other authorised party, for example another signatory RU, the contractual consignee of the goods carried or the operator of private sidings authorised to take delivery of the wagon.

Article 2: Scope of application

2.1 This contract shall take precedence in international rail traffic over the CUV Uniform Rules (Annex D to the 1999 COTIF) and in domestic rail traffic over any national regulations that may be applicable, to the extent that this is admissible.

2.2 Admission shall be effective from the first day of the following month, provided that the application has been received by the GCU Bureau at least fifteen days before.

2.3 The provisions of this multilateral contract shall apply between the signatories to the extent that they have not concluded other provisions between themselves.

2.4 The GCU Bureau shall publish an updated list of signatories (Appendix 1, available on the website at www.gcubureau.org) every month, on the first day of the calendar month in question.

Article 3: Termination

3.1 Any signatory may withdraw from this contract at the end of each calendar year subject to notice of at least six months in a written declaration to be sent to the GCU Bureau. Termination and the date from which it becomes effective shall be published monthly by the GCU Bureau together with the list referred to in article 2.4.

3.2 In addition, any signatory having voted against a proposed modification of the contract may withdraw from the contract as of the entering into force of such modification by a written declaration to be sent to the GCU Bureau within six weeks after adoption of the modification by the majority of the signatories.

Article 4: Further development of the contract

The parties to the GCU shall adopt an Internal Regulation (Appendix 8) for the further development of the contract. The GCU Bureau shall be responsible for editing and coordinating any such modifications of the GCU.

Article 5: Discontinuance of being a signatory

If due amounts of more than 100 EUR owed by a signatory according to section I point 12 of Appendix 8 have been outstanding for more than six months and after an additional request for payment are not paid by the signatory within two months after the request has been sent, the discontinuance of its being a signatory shall be published in the monthly list according to article 2.4. From then on it shall be considered to be a third party according to articles 16 and 17.

Article 6: in abeyance

CHAPTER II

OBLIGATIONS AND RIGHTS OF THE WAGON KEEPER

Article 7: Technical admission and maintenance of wagons

- 7.1 The keeper shall ensure that his wagons are technically admitted* in accordance with the national and international laws and regulations in force at the time of admission and that they remain technically admitted throughout the period of their use.
- 7.2 The keeper shall ensure that his wagons are maintained in accordance with the laws, regulations and mandatory standards in force. In particular, he shall appoint a certified Entity in Charge of Maintenance (ECM) and ensure that the latter performs all of its assigned tasks.
Upon request, the keeper shall make available to any user RU without delay reliable information about maintenance (including Maintenance File and Maintenance Record File) and restrictions affecting operations, necessary and sufficient to support safe operations.
For the purposes of this contract and vis-à-vis the other signatories, the keeper is considered to be, and have the responsibilities of, the ECM for his wagons.
- 7.3 The keeper must allow the RUs to conduct any inspections on wagons that may be necessary, in particular those referred to in Appendix 9.
- 7.4 The keeper must provide the impacted user railway undertakings with the information on its wagons required for safe railway operations in electronic format as soon as possible. The provision of this information and additional data - where relevant - is provided for in Appendix 16.

Article 8: Inscriptions and signs on the wagon. Identification of the wagon

Without prejudice to the regulations in force, wagons shall carry the following inscriptions:

- indication of the keeper
- inscriptions and signs on the wagons as shown in Appendix 11
- where appropriate, the home station or region*.

Article 9: Keeper's right of deployment

- 9.1 The keeper shall have control over his wagons. The keeper may act under this contract through third parties authorized by him. In case of doubt, the instructions of the keeper shall overrule any instruction of a third party claiming to be authorized by the keeper.
- 9.2 Except when justified for reasons of safety, only the keeper shall be authorised to issue instructions to RUs regarding the use of his wagons.
- 9.3 The keeper shall provide the RUs with the instructions necessary for the carriage of empty wagons in good time.
- 9.4 Any request from a keeper for his wagons not to be handed over to certain RUs, whether signatory or third party, shall be met.

CHAPTER III OBLIGATIONS AND RIGHTS OF RUs

Article 10: Acceptance of wagons

Subject to compliance by the keeper with the obligations incumbent on him under the provisions of Chapter II, RUs shall accept wagons within the scope of their commercial services* offered.

Article 11: Refusal of wagons

An RU may refuse wagons if

- their acceptance is prohibited by a competent authority;
- it is temporarily impossible to accept them for operating reasons specific to the RU concerned;
- there are exceptional circumstances beyond the control of the RU (cases of force majeure in particular) that temporarily prevent the wagons being accepted;
- the condition of the wagon does not meet technical and maintenance regulations or conform to current loading guidelines;
- there are other substantial reasons which might affect the safe operation of the wagon; such reasons must be notified to the keeper.

An RU may not refuse its own wagons when they are empty and in running order.

Article 12: Handling of wagons

Each RU shall handle wagons with care and due diligence and shall carry out the inspections laid down in Appendix 9. Similarly, it shall carry out in particular all the safety-related inspections needed on wagons, irrespective of their keeper. The costs relating to these routine inspections shall not be separately invoiced to the keeper.

Article 13: Wagon periods for carriage and liability

13.1 The periods for carriage for loaded wagons shall depend on the transit period for the goods being conveyed. Periods for carriage for empty wagons shall be determined by agreement. In the absence of such an agreement, the periods set out in Article 16 of the CIM for wagon-load consignment shall apply.

13.2 The user RU shall not be held liable for exceeding the periods for carriage when this is caused by:

- the fault of the keeper,
- an order placed by the keeper not resulting from a fault of the user RU,
- a defect on the wagon or its load,
- circumstances that the user RU could not avoid and the consequences of which it could not prevent,
- justified refusal of the wagon or shipment as covered by Article 11.

13.3 If these periods are exceeded for a reason ascribable to an RU, the keeper may claim compensation for loss of use of the wagons. Unless otherwise agreed, the amount of compensation for loss of use shall be calculated from Appendix 6. This amount, added to the compensation for damage specified in Article 23.2, may not exceed the amount payable for loss of the wagon. It shall be charged in addition to the compensation for loss granted under Articles 20.3 or 23.1.

Article 14: Deployment of empty wagons

- 14.1 The RU shall execute the instructions given by the keeper for the carriage of empty wagons within the scope of their commercial services offered.
- 14.2 The documents listed below, included in Appendix 3, shall be used when forwarding empty wagons:
- wagon note,
 - charges note,
 - subsequent orders,
 - notification of circumstances preventing carriage,
 - notification of circumstances preventing delivery.

These documents may be issued in paper format or recorded electronically.

The procedure agreed on among parties to the contract of use for issuing these documents in electronic format must ensure the integrity and reliability of the information they contain as of the moment they are issued. The procedure agreed on among parties to the contract of use for completing or amending the electronic wagon note must ensure amendments are identifiable. It must also ensure that the original information contained in the electronic wagon note is preserved. The electronic wagon note must be authenticated. Authentication may take the form of an electronic signature or other suitable procedure.

The arrangements for handling these documents in paper or electronic format are set out in the Wagon Note Guide of the CUV (GLW-CUV), published by the International Railway Transport Committee (CIT).

- 14.3 If the keeper has failed to issue instructions by the time the RU takes the wagon back after unloading at the latest, the RU shall be obliged to send the wagon back to its home station or region or to any other previously agreed station.

Article 15: Information to be supplied to the keeper

User RUs shall supply the keeper with information on the use of his wagons in a timely manner, in accordance with the national and international laws and regulations in force.

Article 16: Handover of a wagon to third parties

An RU that hands over a wagon to a third party without the authorization of the keeper shall be liable to the latter in particular for any damage that may result. The liability of the third party remains unaffected.

Article 17: Acceptance of wagons from third party keepers

The present contract shall apply to wagons whose keepers are not GCU signatories from the moment they are accepted by a signatory RU as part of a handover or exchange. In such cases, the RU which accepts the wagon is considered as its keeper vis-à-vis the other parties to the GCU for this run and for the empty return run following it. This is to be indicated in the CUV wagon note.

CHAPTER IV

ASCERTAINMENT AND HANDLING OF DAMAGE TO WAGONS IN THE CUSTODY OF AN RU

Article 18: Ascertainment of damage

- 18.1 When damage to a wagon or the loss or damage of the removable accessories mentioned on the wagon are discovered or presumed by an RU or the keeper claims they exist, the RU shall without delay and, if possible, in the keeper's presence, draw up a wagon damage report (as per Appendix 4) documenting the nature of the damage or loss and, insofar as possible, the cause and the time it took place.
- 18.2 When the damage or loss of parts does not prevent use of the wagon in traffic, the keeper does not need to be invited when the damage or loss is recorded.
- 18.3 A copy of the wagon damage report shall be sent to the keeper without delay.
- 18.4 If the keeper does not accept the contents of the wagon damage report, he may ask for the nature, cause and extent of damage to be recorded by an expert appointed by the parties to the contract or by judicial means. This procedure shall be subject to the law of the country in which it takes place.
- 18.5 When a wagon sustains damage or loss of a part and is unable to run or be used as a result, the RU shall also inform the keeper immediately, providing the following information as a minimum:
- the wagon number
 - the status of the wagon (loaded or empty)
 - the date and place it was withdrawn from service
 - reason for withdrawal from service
 - details of the department to contact
 - probable duration of wagon unavailability (up to 6 working days; more than 6 working days).

Article 19: Handling of damage

- 19.1 The RU shall arrange for the wagon to be put back to running order in accordance with the provisions of Appendix 10. If the cost of repairs is more than 850 EUR, the agreement of the keeper must first be sought, except in the case of brake block replacements or if Appendix 13 is applied by the RU. If the keeper does not respond after 2 working days (not including Saturdays) the repair work shall go ahead.
- 19.2 If the cost of repairing the damaged wagon is greater than the compensation calculated according to Appendix 5, the wagon shall be considered beyond repair from an economic point of view.
- 19.3 When the damage does not affect the wagon's suitability to run, but makes its use difficult, the RU may carry out work to make the wagon fit for use again without the keeper's agreement, up to an amount of 850 EUR. By agreement with the keeper, the RU may be authorised to carry out additional work.

- 19.4 The RU that initiated the maintenance in accordance with Appendix 10 shall check whether and to what extent the work requested has been completed on the basis of information received from the workshop.

Any restrictions on use (e.g. fitness to run, fitness for service) that become apparent after the repairs must be documented by the RU.

On completion of the repairs and failing any specific instructions from the keeper, the RU shall forward the wagon to the destination station for which it was initially bound.

- 19.5 In cases where the RU carries out measures in application of the provisions of Appendix 9, it shall do so with qualified staff and all due care. In the context of the preceding provision, "qualified staff" (operations staff) means staff possessing the competences and authorisations to take corrective measures, described in the RU's safety management system (SMS).

Repair work in application of the provisions of Appendix 10 may only be performed by approved workshops.

Approved workshops are:

- a) Workshops which have a valid certificate for an entity in charge of maintenance (ECM certificate) containing the maintenance delivery function as a minimum,
- and
- b) are listed in the European Railway Agency Database of Interoperability and Safety (ERADIS)
- and
- c) which are conversant with Appendices 7, 9, 10 and 13 to the GCU and instruct their employees on changes to the GCU on a regular basis.

The RU or his auxiliary must inform the keeper of the work performed, using the codes provided in Appendix 10, Annex 6.

- 19.6 Management of spare parts is covered in Appendix 7.

- 19.7 Coverage of the cost of repair work is dealt with in Chapter V.

Article 20: Handling of lost wagons and removable accessories

- 20.1 A wagon shall be considered lost if it is not placed at the keeper's disposal within three months following the day of receipt of his search request by the RU to which he provided the wagon, or if the keeper has received no indication on the whereabouts of the wagon. To this period shall be added the time during which the wagon is immobilised for any reason not ascribable to the RU or because of damage.

- 20.2 A piece of removable accessory mentioned on the wagon shall be considered lost if it is not returned with the vehicle.

- 20.3 If an RU is liable, it shall pay the keeper:

- for a lost wagon, compensation calculated in accordance with Appendix 5
- for lost accessory, compensation amounting to the value of the part in question.

- 20.4 The keeper, on receiving the compensation, may request in writing to be notified when the wagon (or removable accessory) is found. In this case, the keeper may require that within six months of receiving the notification, the wagon (or removable tackle) be returned to him against repayment of the compensation received. The period between payment of compensation for loss of the wagon and repayment thereof by the keeper shall not qualify him for any compensation for loss of use.

Article 21: Handling of bogies

The provisions of this chapter shall apply in the same way to the handling of bogies.

CHAPTER V

LIABILITY IN THE EVENT OF LOSS OF OR DAMAGE TO A WAGON

Article 22: Liability of the user RU

22.1 The RU which has custody of a wagon shall be liable to the keeper for any loss of or damage to the wagon or accessories unless it proves that the damage was not caused by fault on its parts.

22.2 The RU shall not be liable if it brings proof of one of the following:

- circumstances that the RU was not able to avoid and the consequences of which it could not prevent;
- fault of a third party;
- insufficient maintenance by the keeper when the RU can prove that the wagon was properly used and inspected;
- fault of the keeper.

If the RU is found to be partly responsible, the damage shall be borne by the responsible parties in proportion to their respective share of responsibility.

The keeper cannot cite the existence of a hidden defect on his wagon as proof that there was no fault of his part.

22.3 The RU shall not be liable for:

- loss of or damage to removable accessories that is not listed on both sides of the wagon;
- loss of and damage to removable tackles (filling hoses, tools, etc.),
provided that it cannot be shown to be at fault.

22.4 To facilitate the handling of damage and take account of the normal wear and tear of the wagon, the quality of its maintenance and its use by third parties, the damage catalogue in Appendix 12 shall be applied as follows:

- damage assigned to the keeper shall be borne by the keeper; independently of this, the keeper may, for damage in excess of 850 EUR, seek recourse against an RU, if he can bring proof that the RU in question was at fault,
- damage assigned to the RU shall be borne by the user RU up to a maximum of 850 EUR,
- damage assigned to the RU in excess of 850 EUR shall be handled in accordance with the provisions of Article 22.1.

Article 23: Amount of compensation

- 23.1 In case of loss of the wagon or its accessories, the amount of compensation shall be calculated in accordance with Appendix 5.
- 23.2 In case of damage to the wagon or its accessories, compensation shall be limited to the cost of repairs. Compensation for loss of use shall be granted in accordance with Article 13.3 and compensation for the change in operational value for damaged wheelsets in accordance with Appendix 6, Part II. When a request is sent to the keeper for spare parts to carry out repair work, the period of loss of use shall be suspended between the date of the request and the date on which the parts are received. The total amount of compensation (for loss of use and for reprofiling wheelsets) may not exceed the amount that would be payable for loss of the wagon.

Article 24: Liability of previous users

- 24.1 When the RU which has custody of a wagon is not liable, each previous user in the current chain of use (loaded or empty run) shall be liable to the keeper for any damage to the wagon and for the loss of or damage to its accessories in accordance with Article 22, if the subsequent RUs in the chain of use could exonerate themselves under the terms of Article 22.
- 24.2 Outside of the current chain of use, previous user shall only be liable to the keeper if the keeper can prove that this user caused the damage and if this user cannot exonerate himself under Article 22.

Article 25: Obligation to mitigate losses

When payment is made for damage caused to wagons, the parties to the contract shall abide by the general principles associated with the obligation to limit the resulting losses.

Article 26: Settlement of damages

The user RU or workshop acting as its auxiliary shall invoice the cost of repairing the wagon to the keeper, with the exception of costs for which the user RU is liable under the terms of Article 22. When the previous user is liable for the damage, the keeper shall send that user an invoice for the cost of the repairs for which he was himself invoiced by the user RU or workshop. The keeper may claim compensation for loss of use, in accordance with Article 13.

CHAPTER VI

LIABILITY IN THE EVENT OF DAMAGE CAUSED BY A WAGON

Article 27: Principle of liability

- 27.1 The keeper or a previous user subject to this contract shall be liable for damage caused by the wagon when they can be shown to be at fault. The keeper shall be presumed to be at fault if he has not correctly fulfilled his duties as these arise from Article 7, unless this breach of duty did not cause or contribute to the damage.
- 27.2 The liable party shall indemnify the user RU against any third party claims if the user RU is not at fault.
- 27.3 Where the user RU is partly responsible, the compensation shall be borne by each party in proportion to its respective share of responsibility.
- 27.4 When a third party is responsible or partly responsible for the damage, the parties to the contract shall claim compensation for the damage primarily from this third party. In particular the signatory which has a contract with the third party shall pursue the claim vis-à-vis the third party as a matter of priority.
- 27.5 Upon request, the keeper shall be required to provide proof of his civil liability insurance in accordance with applicable laws.

CHAPTER VII
LIABILITY FOR STAFF AND OTHER PERSONS

Article 28: Principle of liability

The contracting parties shall be liable for their servants and other persons whose services they make use of for the performance of the contract, when these servants and other persons are acting within the scope of their functions.

CHAPTER VIII OTHER PROVISIONS

Article 29: Loading guidelines

The RUs shall ensure that shippers comply with the UIC loading guidelines in force.

Article 30: Accountancy, payments and interests on late payments

30.1 The EURO (ISO code: EUR) shall be used as the sole monetary unit for all accounts and payments.

30.2 Payment must be made within 60 days following the date of receipt of the invoice, accompanied by the appropriate supporting documentation. An invoice is considered to be paid once the full amount due is credited on the account specified by the creditor.

30.3 If the payment period is exceeded, the creditor may charge interest for late payment from the sixty-first (61st) day for the unpaid amount.

30.4 The yearly interest rate is calculated as follows: the interest rate applied by the European Central Bank to its most recent main refinancing operations (MRO) plus 800 basis points. Basis for the calculation is the interest rate in force on the 1st of January of the calendar year in which the invoice was established.

Article 31: Obligation to pay damages

When a signatory fails by its own fault to meet an obligation which is due under this contract, he shall compensate the affected signatory for the direct damages suffered.

Article 32: Competent jurisdiction

Unless otherwise agreed between the parties, the competent jurisdiction shall be that in which the defendant is established.

Article 33: Limitation

33.1 The period of limitation for actions based on chapter III shall be one year. The period of limitation for actions based on chapters V and VI shall be three years.

33.2 The period of limitation shall run as follows:

- a) for claims brought under chapter III, from the day when the agreed period or the periods specified in the CIM expire;
- b) for claims brought under chapter V, from the day when the loss of or damage to the wagon was recorded or the day when the keeper could consider the wagon or the accessories lost in accordance with Article 20;
- c) for claims brought under chapter VI, from the day on which the damage occurred.

Article 34: Languages

The present contract exists in English, German and French; each language version has the same contractual value.

Two GCU members with different national languages must carry out their correspondence in one of the official GCU languages. The fields in the form in Appendix 4 must thus be written in at least one of those three languages. Invoices may be issued in the national language of the place of issue. The provisions of Annex 6 of Appendix 10 (coding of interventions) remain unaffected.

Article 35: Entry into force

This contract shall enter into force on 1.7.2006

APPENDIX 1 TO THE GENERAL CONTRACT OF USE

LIST OF SIGNATORY KEEPERS AND RUs
--

The updated list of signatories, and address details as defined in Article 2.4 of the GCU, can be found in the database on the GCU Bureau website:

www.gcubureau.org/signatories

Each signatory is obliged, depending on its own organisation, to enter the information relating to it directly on the above website in accordance with the format specified therein.

APPENDIX 2

TO THE GENERAL CONTRACT OF USE FOR WAGONS

DEFINITIONS

COMMERCIAL SERVICE

Denotes the services and commercial conditions offered by an RU to keepers and other RUs. These services comprise, in particular, the routes served, the products or goods accepted in the trains, the different ways of carriage and the prices of the services provided.

COMPETENT NATIONAL AUTHORITY

The national authority responsible for technical admission in accordance with the laws and regulations in force in each country.

HOME STATION; GEOGRAPHICAL AREA

Home station: designated station marked on the wagon and to which an empty wagon must be sent if no other instruction is received from the keeper.

Geographical area: geographical area covering a number of stations in a given region to which an empty wagon must be returned if no other instruction is received from the keeper.

INFRASTRUCTURE MANAGER

Any entity or undertaking responsible in particular for the establishment and maintenance of railway infrastructure. This may also include the management of infrastructure control and safety systems. The functions of infrastructure manager across all or part of a network may be entrusted to several different entities or companies.

PREVIOUS USER

An RU that used a wagon of which it was not the keeper, having subsequently handed it over to another RU for use.

RAILWAY UNDERTAKING

Any public or private undertaking, licensed according to applicable Community legislation, the principal business of which is to provide services for the transport of goods and/or passengers by rail with a requirement that the undertaking must ensure traction; this also includes undertakings which provide traction only.

TECHNICAL ADMISSION

Procedure by the competent national authority to approve a railway vehicle for running.

TSI

Technical Specification for Interoperability for the trans-European conventional rail system.

WAGON KEEPER or KEEPER

means the person or entity that, being the owner of a wagon or having the right to use it, exploits the wagon as a means of transport and is registered as keeper of the wagon in the competent official vehicle register, or, if the wagon is not registered in the competent official vehicle register or such a register is not existing, the person or entity that has declared to the GCU Bureau to be keeper of the wagon.

WAGON IN RUNNING ORDER (operating term)

Wagon that is in running order on its own wheels in freight trains under normal operating conditions, where appropriate at the end of a train, without representing a hazard for operations.

WAGON NOTE

Forwarding and deployment document accompanying a wagon making an empty run (see specimen in Appendix 3).

WAGON TARE

Total mass of the unloaded wagon, expressed in kilograms and marked on each side of the wagon (for marking rules, see Appendix 11). The marked tare must not differ from the actual observed mass of the wagon by more than 100 kilograms (heavier/lighter) per wheelset on the wagon.

APPENDIX 3 TO THE GENERAL CONTRACT OF USE

DOCUMENTS RELATING TO THE CONVEYANCE OF EMPTY WAGONS.

--

- 3.1 Wagon note
- 3.2 Wagon note for Combined Transport
- 3.3 Charges note
- 3.4 Subsequent orders
- 3.5 Notification of prevention of conveyance
- 3.6 Notification of prevention of handover

3.1 Wagon note

1 **30** To be completed by the consignor / À remplir par l'expéditeur **X** Mark the box applicable with a cross - Désigner par une croix ce qui convient (Boxes - Cases 20, 22, 23, 30, 52, 58)

<p>Notwithstanding any clause to the contrary, carriage of goods shall be subject to the CIM Uniform Rules. In addition, the carrier's General Terms and Conditions of Carriage shall apply. <i>Nonobstant toute clause contraire, le transport des marchandises est soumis aux Règles uniformes CIM. Sont en outre applicables les conditions générales de transport du transporteur.</i></p> <p>Except as otherwise agreed, the hire of empty wagons shall be subject to the CUV Uniform Rules. In addition the relevant contractual conditions of the railway undertaking shall apply. <i>Sauf convention contraire, l'achèvement des wagons vides est soumis aux Règles uniformes CUV. Sont en outre applicables les conditions contractuelles topiques de l'entreprise de transport ferroviaire.</i></p>		<p>30 CIM Consignment Note Lettre de voiture CIM <input type="checkbox"/></p>		<p>CUV Wagon Note Lettre wagon CUV <input type="checkbox"/></p>		<p>40 _____ 41 _____ 42 _____ 43 _____</p> <p>44 _____ 45 _____ 46 _____ 47 _____</p>	
<p>1 Consignor (name, address) - Expéditeur (nom, adresse)</p> <p>Signature</p> <p>VAT no. N° TVA</p>		<p>2 _____</p> <p>3 _____</p> <p>E-Mail</p> <p>Tel.</p> <p>Fax</p>		<p>7 Consignor's declarations Déclarations de l'expéditeur</p>		<p>8 Consignor's reference - Référence expéditeur</p>	
<p>4 Consignee (name, address, country) Destinataire (nom, adresse, pays)</p> <p>VAT no. N° TVA</p>		<p>5 _____</p> <p>6 _____</p> <p>E-Mail</p> <p>Tel.</p> <p>Fax</p>		<p>9 Documents attached - Annexes</p>			
<p>10 Delivery point Lieu de livraison</p>		<p>11 _____</p>		<p>12 _____</p>		<p>16 Acceptance Prise en charge month - day - hour mois - jour - heure</p> <p>Point - Lieu</p>	
<p>Station - Gare</p>		<p>Country - Pays</p>		<p>18 Wagon no. - Wagon N°</p>		<p>19 Section - Parcours by - par</p> <p>Sectional invoicing Facturation transit</p>	
<p>15 Commercial specification - Conditions commerciales</p>		<p>14 _____</p>		<p>20 Payment instructions Paiement des frais including - y compris up to - jusqu'à</p> <p><input type="checkbox"/> Carriage charges paid Francé de port</p> <p><input type="checkbox"/> Incoterms _____</p>			
<p>15 Information for the consignee - informations pour le destinataire</p>							
<p>21 Description of the goods Désignation de la marchandise</p>		<p>22 Exceptional consignment Transport exceptionnel yes <input type="checkbox"/> out <input type="checkbox"/></p>		<p>23 RID yes <input type="checkbox"/> out <input type="checkbox"/></p>		<p>24 NIM code</p>	
						<p>25 Mass (weight) Masse</p>	
						<p>26 Declaration of value Déclaration de valeur Currency</p>	
						<p>27 Interest in delivery Intérêt à la livraison Monnaie</p>	
						<p>28 Cash on delivery Remboursement Currency</p>	
						<p>48 Examination Vérification</p>	
						<p>80 Customs end/orsements Indications douanières</p>	
						<p>by - par</p>	
<p>70 Section Parcours</p>		<p>71 _____</p>		<p>72 _____</p>		<p>73 _____</p>	
<p>75 _____</p>		<p>76 _____</p>		<p>77 _____</p>		<p>78 _____</p>	
<p>70 Section Parcours</p>		<p>71 _____</p>		<p>72 _____</p>		<p>73 _____</p>	
<p>75 _____</p>		<p>76 _____</p>		<p>77 _____</p>		<p>78 _____</p>	
<p>70 Section Parcours</p>		<p>71 _____</p>		<p>72 _____</p>		<p>73 _____</p>	
<p>75 _____</p>		<p>76 _____</p>		<p>77 _____</p>		<p>78 _____</p>	
						<p>49 Prepayment coding - Code d'affranchissement</p>	
						<p>50 Route - Itinéraires</p>	
						<p>51 Customs procedures - Opérations douanières</p>	
						<p>52 Charges note Bulletin d'affranchissement yes <input type="checkbox"/> out <input type="checkbox"/> returned renvoyé month - day mois - jour</p>	
						<p>53 Notification of payment no. Avis d'encaissement N° returned renvoyé month - day mois - jour</p>	
						<p>54 Formal report no. Procès-verbal N° made out by établi par month - day mois - jour</p>	
						<p>55 Extension of transit time - Prolongation du délai de livraison Code from - du to - au place - lieu</p>	
<p>56 Carrier's declarations - Déclarations du transporteur</p>		<p>57 Other carriers - Autres transporteurs Name, address - Nom, adresse</p>		<p>Section - Parcours</p>		<p>Status Qualité</p>	
<p>58 a) Contractual carrier - Transporteur contractuel</p> <p>Signature</p>		<p>59 Date of arrival - Date d'arrivée</p> <p>Arrival no. - Arrivage N°</p>		<p>60 Made available Mise à disposition month - day - hour mois - jour - heure</p>		<p>62 Consignment number Identification de l'envoi Country - Pays Station - Gare</p> <p>Undertaking Entreprise Consign no. Exp. N°</p>	
<p>b) Simplified transit procedure for rail Procédure simplifiée de transit ferroviaire yes <input type="checkbox"/> out <input type="checkbox"/></p> <p>Code for the principal Code principal obligé</p>		<p>Original</p>		<p>61 Acknowledgement of receipt Quittance du destinataire</p>		<p>29 Place and date completed - Lieu et date d'établissement</p>	
				<p>1</p>		<p>Date, signature</p>	

Point 6.7.8

© 2006 CIT

Original

1

Charging sections (continued) – Sections de taxation (suite)				Charges paid – Franco		To pay – Port dû		
				Invoicing currency Monnaie d'encaissement	Tarif currency Monnaie du tarif	Tarif currency Monnaie du tarif	Invoicing currency Monnaie d'encaissement	
				Cash on delivery (brought forward from the front) / Remboursement (Report du recto)				80
								80 Ex. Rate
								80
				81	82			
				83 Cours	84	85	86 Cours	
				87	88	89	90	
				87	88	89	90	
				83 Ex. Rate	84	85	86 Ex. Rate	
				87	88	89	90	
				87	88	89	90	
				83 Cours	84	85	86 Cours	
				87	88	89	90	
				87	88	89	90	
				83 Ex. Rate	84	85	86 Ex. Rate	
				87	88	89	90	
				87	88	89	90	
				83 Cours	84	85	86 Cours	
				87	88	89	90	
				87	88	89	90	
				Brought forward from supplementary sheets / Report des feuilles supplémentaires			92	
				Grand total – Montant général			94	

				Brought forward from the front – Report du recto			
				A Charges			
				B Frais			
				C Charges			
70	Section	71	72	73			
75	Parcours	76	77	78			
70	Section	71	72	73			
75	Parcours	76	77	78			
70	Section	71	72	73			
75	Parcours	76	77	78			
70	Section	71	72	73			
75	Parcours	76	77	78			

1 To be completed by the consignor / À remplir par l'expéditeur **X** Mark the box applicable with a cross - Désigner par une croix ce qui convient (Boxes - Cases 20, 22, 23, 30, 52, 58)

<p>Notwithstanding any clause to the contrary, carriage of goods shall be subject to the CIM Uniform Rules. In addition, the carrier's General Terms and Conditions of Carriage shall apply. Nonobstant toute clause contraire, le transport des marchandises est soumis aux Règles uniformes CIM. Sont en outre applicables les conditions générales de transport du transporteur.</p> <p>Except as otherwise agreed, the haulage of empty wagons shall be subject to the CUV Uniform Rules. In addition the relevant contractual conditions of the railway undertaking shall apply. Sauf convention contraire, l'acheminement des wagons vides est soumis aux Règles uniformes CUV. Sont en outre applicables les conditions contractuelles typiques de l'entreprise de transport ferroviaire.</p>		<p>30 CIM Consignment Note Lettre de voiture CIM <input type="checkbox"/></p>		<p>CUV Wagon Note Lettre wagon CUV <input type="checkbox"/></p>		<p>40 41 42 43 44 45 46 47</p>	
<p>1 Consignor (name, address) - Expéditeur (nom, adresse)</p> <p>Signature</p> <p>VAT no. / N° TVA</p>		<p>2</p> <p>3</p> <p>E-Mail</p> <p>Tel.</p> <p>Fax</p>		<p>7 Consignor's declarations / Déclarations de l'expéditeur</p>		<p>8 Consignor's reference - Référence expéditeur</p>	
<p>4 Consignee (name, address, country) / Destinataire (nom, adresse, pays)</p> <p>VAT no. / N° TVA</p>		<p>5</p> <p>6</p> <p>E-Mail</p> <p>Tel.</p> <p>Fax</p>		<p>9 Documents attached - Annexes</p>			
<p>10 Delivery point / Lieu de livraison</p>		<p>11</p>		<p>12</p>		<p>16 Acceptance / Prise en charge month - day - hour / mois - jour - heure</p> <p>Point - Lieu</p>	
<p>Station - Gare</p>		<p>Country - Pays</p>		<p>18 Wagon no. - Wagon N°</p>		<p>19 Section - Parcours by - par</p> <p>Sectional invoicing / Facturation Transit</p>	
<p>13 Commercial specification - Conditions commerciales</p>		<p>14</p>		<p>20 Payment instructions / Paiement des frais including - y compris up to - jusqu'à</p> <p><input type="checkbox"/> Carriage charges paid / Franco de port</p> <p><input type="checkbox"/> Incoterms</p>			
<p>15 Information for the consignee - informations pour le destinataire</p>				<p>22 Exceptional consignment / Transport exceptionnel yes / oui <input type="checkbox"/></p> <p>23 RID yes / oui <input type="checkbox"/></p> <p>24 NIM code</p> <p>25 Mass (weight) / Masse</p>		<p>26 Declaration of value / Déclaration de valeur Currency</p> <p>27 Interest in delivery / Intérêt à la livraison Monnaie</p> <p>28 Cash on delivery / Remboursement Currency</p> <p>48 Examination / Vérification</p>	
<p>21 Description of the goods / Désignation de la marchandise</p>				<p>29 Customs end/orsements / Indications douanières</p>			
<p>70 Section / Parcours</p>		<p>71</p>		<p>72</p>		<p>73</p>	
<p>75</p>		<p>76</p>		<p>77</p>		<p>78</p>	
<p>70 Section / Parcours</p>		<p>71</p>		<p>72</p>		<p>73</p>	
<p>75</p>		<p>76</p>		<p>77</p>		<p>78</p>	
<p>70 Section / Parcours</p>		<p>71</p>		<p>72</p>		<p>73</p>	
<p>75</p>		<p>76</p>		<p>77</p>		<p>78</p>	
<p>49 Prepayment coding - Code d'affranchissement</p>		<p>50 Route - Itinéraires</p>		<p>51 Customs procedures - Opérations douanières</p>		<p>52 Charges note / Bulletin d'affranchissement yes / oui <input type="checkbox"/> returned / renvoyé month - day / mois - jour</p>	
<p>53 Notification of payment no. / Avis d'encaissement N° returned / renvoyé month - day / mois - jour</p>		<p>54 Formal report no. / Procès-verbal N° made out by / établi par month - day / mois - jour</p>		<p>55 Extension of transit time - Prolongation du délai de livraison Code form - du to - au place - lieu</p>			
<p>56 Carrier's declarations - Déclarations du transporteur</p>		<p>57 Other carriers - Autres transporteurs Name, address - Nom, adresse</p>		<p>Section - Parcours</p>		<p>Status / Qualité</p>	
<p>58 a) Contractual carrier - Transporteur contractuel</p> <p>Signature</p>		<p>59 Date of arrival - Date d'arrivée</p> <p>Arrival no. - Arrivage N°</p>		<p>60 Made available / Mise à disposition month - day - hour / mois - jour - heure</p>		<p>62 Consignment number / Identification de l'envoi Country - Pays Station - Gare</p> <p>Undertaking / Entreprise Consign't no. / Exp. N°</p>	
<p>b) Simplified transit procedure for rail / Procédure simplifiée de transit ferroviaire yes / oui <input type="checkbox"/></p> <p>Code for the principal / Code principal obligé</p>		<p>Invoice / Feuille de route</p>		<p>61 Acknowledgement of receipt / Quitteuse du destinataire</p>		<p>63 Place and date completed - Lieu et date d'établissement</p>	
				<p>2</p>			
				<p>Date, signature</p>			

1 To be completed by the consignor / À remplir par l'expéditeur **X** Mark the box applicable with a cross - Désigner par une croix ce qui convient (Boxes - Cases 20, 22, 23, 30, 52, 58)

<p>Notwithstanding any clause to the contrary, carriage of goods shall be subject to the CIM Uniform Rules. In addition, the carrier's General Terms and Conditions of Carriage shall apply. Nonobstant toute clause contraire, le transport des marchandises est soumis aux Règles uniformes CIM. Sont en outre applicables les conditions générales de transport du transporteur.</p> <p>Except as otherwise agreed, the haulage of empty wagons shall be subject to the CUV Uniform Rules. In addition the relevant contractual conditions of the railway undertaking shall apply. Sauf convention contraire, l'acheminement des wagons vides est soumis aux Règles uniformes CUV. Sont en outre applicables les conditions contractuelles topiques de l'entreprise de transport ferroviaire.</p>		<p>30 CIM Consignment Note Lettre de voiture CIM <input type="checkbox"/></p>		<p>CUV Wagon Note Lettre wagon CUV <input type="checkbox"/></p>		<p>40 41 42 43 44 45 46 47</p>	
<p>1 Consignor (name, address) - Expéditeur (nom, adresse)</p> <p>Signature</p> <p>VAT no. / N° TVA</p>		<p>2</p> <p>3</p> <p>E-Mail</p> <p>Tel.</p> <p>Fax</p>		<p>7 Consignor's declarations / Déclarations de l'expéditeur</p>		<p>8 Consignor's reference - Référence expéditeur</p>	
<p>4 Consignee (name, address, country) / Destinataire (nom, adresse, pays)</p> <p>VAT no. / N° TVA</p>		<p>5</p> <p>6</p> <p>E-Mail</p> <p>Tel.</p> <p>Fax</p>		<p>9 Documents attached - Annexes</p>		<p>16 Acceptance / Prise en charge</p> <p>month - day - hour / mois - jour - heure</p> <p>Point - Lieu</p>	
<p>10 Delivery point / Lieu de livraison</p> <p>Station - Gare</p>		<p>11</p> <p>Country - Pays</p>		<p>12</p>		<p>17</p>	
<p>13 Commercial specification - Conditions commerciales</p>		<p>14</p>		<p>18 Wagon no. - Wagon N°</p>		<p>19 Section - Parcours</p> <p>by - par</p>	
<p>15 Information for the consignee - Informations pour le destinataire</p>		<p>20 Payment instructions / Paiement des frais</p> <p>including - y compris / up to - jusqu'à</p> <p><input type="checkbox"/> Carriage charges paid / Franco de port</p> <p><input type="checkbox"/> Incoterms</p>		<p>21 Description of the goods / Désignation de la marchandise</p>		<p>22 Exceptional consignment / Transport exceptionnel</p> <p>yes / oui <input type="checkbox"/></p>	
<p>23 RID</p> <p>yes / oui <input type="checkbox"/></p>		<p>24 NIM code</p>		<p>25 Mass (weight) / Masse</p>		<p>26 Declaration of value / Déclaration de valeur</p> <p>Currency / Monnaie</p>	
<p>27 Interest in delivery / Intérêt à la livraison</p> <p>Monnaie</p>		<p>28 Cash on delivery / Remboursement</p> <p>Currency / Monnaie</p>		<p>29 Examination / Vérification</p>		<p>30 Customs endorsements / Indications douanières</p>	
<p>70 Section - Parcours</p>		<p>71</p>		<p>72</p>		<p>73</p>	
<p>74</p>		<p>75</p>		<p>76</p>		<p>77</p>	
<p>78</p>		<p>79</p>		<p>80</p>		<p>81</p>	
<p>82 Prepayment coding - Code d'affranchissement</p>		<p>83 Route - Itinéraires</p>		<p>84</p>		<p>85</p>	
<p>86 Customs procedures - Opérations douanières</p>		<p>87 Charges note / Bulletin d'affranchissement</p> <p>yes / oui <input type="checkbox"/></p> <p>returned / renvoyé</p> <p>month - day / mois - jour</p>		<p>88 Notification of payment no. / Avis d'encaissement N°</p> <p>returned / renvoyé</p> <p>month - day / mois - jour</p>		<p>89 Formal report no. / Procès-verbal N°</p> <p>made out by / établi par</p> <p>month - day / mois - jour</p>	
<p>90 Extension of transit time - Prolongation du délai de livraison</p> <p>Code / form - du / to - au / place - lieu</p>		<p>91 Carrier's declarations - Déclarations du transporteur</p>		<p>92 Other carriers - Autres transporteurs</p> <p>Name, address - Nom, adresse</p> <p>Section - Parcours</p> <p>Status / Qualité</p>		<p>93 Contractual carrier - Transporteur contractuel</p> <p>Signature</p>	
<p>94 Date of arrival - Date d'arrivée</p> <p>Arrival no. - Arrivage N°</p>		<p>95 Made available / Mise à disposition</p> <p>month - day - hour / mois - jour - heure</p>		<p>96 Acknowledgement of receipt / Quitteuse du destinataire</p>		<p>97 Consignment number / Identification de l'envoi</p> <p>Country - Pays</p> <p>Station - Gare</p> <p>Undertaking / Entreprise</p> <p>Consign't no. / Exp. N°</p>	
<p>98 Simplified transit procedure for rail / Procédure simplifiée de transit ferroviaire</p> <p>yes / oui <input type="checkbox"/></p> <p>Code for the principal / Code principal obligé</p>		<p>99 Arrival note / Customs / Bulletin d'arrivée / Douane</p>		<p>100 Place and date completed - Lieu et date d'établissement</p>		<p>3</p> <p>Date, signature</p>	

1 To be completed by the consignor / À remplir par l'expéditeur **X** Mark the box applicable with a cross - Désigner par une croix ce qui convient (Boxes - Cases 20, 22, 23, 30, 52, 58)

<p>Notwithstanding any clause to the contrary, carriage of goods shall be subject to the CIM Uniform Rules. In addition, the carrier's General Terms and Conditions of Carriage shall apply. Nonobstant toute clause contraire, le transport des marchandises est soumis aux Règles uniformes CIM. Sont en outre applicables les conditions générales de transport du transporteur.</p> <p>Except as otherwise agreed, the haulage of empty wagons shall be subject to the CUV Uniform Rules. In addition the relevant contractual conditions of the railway undertaking shall apply. Sauf convention contraire, l'acheminement des wagons vides est soumis aux Règles uniformes CUV. Sont en outre applicables les conditions contractuelles typiques de l'entreprise de transport ferroviaire.</p>		<p>30 CIM Consignment Note Lettre de voiture CIM <input type="checkbox"/></p>		<p>CUV Wagon Note Lettre wagon CUV <input type="checkbox"/></p>		<p>40 41 42 43 44 45 46 47</p>	
<p>1 Consignor (name, address) - Expéditeur (nom, adresse)</p> <p>Signature</p> <p>VAT no. N° TVA</p>		<p>2</p> <p>3</p> <p>E-Mail</p> <p>Tel.</p> <p>Fax</p>		<p>7 Consignor's declarations Déclarations de l'expéditeur</p>		<p>8 Consignor's reference - Référence expéditeur</p>	
<p>4 Consignee (name, address, country) Destinataire (nom, adresse, pays)</p> <p>VAT no. N° TVA</p>		<p>5</p> <p>6</p> <p>E-Mail</p> <p>Tel.</p> <p>Fax</p>		<p>9 Documents attached - Annexes</p>			
<p>10 Delivery point Lieu de livraison</p>		<p>11</p>		<p>12</p>		<p>16 Acceptance Prise en charge month - day - hour mois - jour - heure</p> <p>17</p>	
<p>Station - Gare</p>		<p>Country - Pays</p>		<p>18 Wagon no. - Wagon N°</p>		<p>19 Section - Parcours by - par Sectional invoicing Facturation Transit</p>	
<p>13 Commercial specification - Conditions commerciales</p>		<p>14</p>		<p>20 Payment instructions Paielement des frais including - y compris up to - jusqu'à</p> <p><input type="checkbox"/> Carriage charges paid Franco de port</p> <p><input type="checkbox"/> Incoterms</p>			
<p>15 Information for the consignee - informations pour le destinataire</p>							
<p>21 Description of the goods Désignation de la marchandise</p>		<p>22 Exceptional consignment Transport exceptionnel yes <input type="checkbox"/> oui</p>		<p>23 RID yes <input type="checkbox"/> oui</p>		<p>24 NIM code</p>	
						<p>25 Mass (weight) Masse</p>	
						<p>26 Declaration of value Déclaration de valeur Currency</p>	
						<p>27 Interest in delivery Intérêt à la livraison Monnaie</p>	
						<p>28 Cash on delivery Remboursement Currency</p>	
						<p>48 Examination Vérification</p>	
						<p>80 Customs endorsements Indications douanières</p>	
						<p>by - par</p>	
<p>70 Section Parcours</p>		<p>71</p>		<p>72</p>		<p>73</p>	
<p>75</p>		<p>76</p>		<p>77</p>		<p>78</p>	
<p>70 Section Parcours</p>		<p>71</p>		<p>72</p>		<p>73</p>	
<p>75</p>		<p>76</p>		<p>77</p>		<p>78</p>	
<p>70 Section Parcours</p>		<p>71</p>		<p>72</p>		<p>73</p>	
<p>75</p>		<p>76</p>		<p>77</p>		<p>78</p>	
						<p>49 Prepayment coding - Code d'affranchissement</p>	
						<p>50 Route - Itinéraires</p>	
						<p>51 Customs procedures - Opérations douanières</p>	
						<p>52 Charges note Bulletin d'affranchissement yes <input type="checkbox"/> oui returned renvoyé month - day mois - jour</p>	
						<p>53 Notification of payment no. Avis d'encaissement N° returned renvoyé month - day mois - jour</p>	
						<p>54 Formal report no. Procès-verbal N° made out by établi par month - day mois - jour</p>	
						<p>55 Extension of transit time - Prolongation du délai de livraison Code form - du to - au place - lieu</p>	
<p>56 Carrier's declarations - Déclarations du transporteur</p>		<p>57 Other carriers - Autres transporteurs Name, address - Nom, adresse</p>		<p>Section - Parcours</p>		<p>Status Qualité</p>	
<p>58 a) Contractual carrier - Transporteur contractuel</p> <p>Signature</p>		<p>59 Date of arrival - Date d'arrivée</p> <p>Arrival no. - Arrivage N°</p>		<p>60 Made available Mise à disposition month - day - hour mois - jour - heure</p>		<p>62 Consignment number Identification de l'envoi Country - Pays Station - Gare</p> <p>Undertaking Entreprise Consign't no. Exp. N°</p>	
<p>b) Simplified transit procedure for rail Procédure simplifiée de transit ferroviaire yes <input type="checkbox"/> oui</p> <p>Code for the principal Code principal obligé</p>		<p>Duplicate Duplicata</p>		<p>61 Acknowledgement of receipt Quittance du destinataire</p>		<p>63 Place and date completed - Lieu et date d'établissement</p>	
				<p>4</p>		<p>Date, signature</p>	

1 To be completed by the consignor / À remplir par l'expéditeur **X** Mark the box applicable with a cross - Désigner par une croix ce qui convient (Boxes - Cases 20, 22, 23, 30, 52, 58)

<p>Notwithstanding any clause to the contrary, carriage of goods shall be subject to the CIM Uniform Rules. In addition, the carrier's General Terms and Conditions of Carriage shall apply. Nonobstant toute clause contraire, le transport des marchandises est soumis aux Règles uniformes CIM. Sont en outre applicables les conditions générales de transport du transporteur.</p> <p>Except as otherwise agreed, the haulage of empty wagons shall be subject to the CUV Uniform Rules. In addition the relevant contractual conditions of the railway undertaking shall apply. Sauf convention contraire, l'acheminement des wagons vides est soumis aux Règles uniformes CUV. Sont en outre applicables les conditions contractuelles typiques de l'entreprise de transport ferroviaire.</p>		<p>30 CIM Consignment Note Lettre de voiture CIM <input type="checkbox"/></p>		<p>CUV Wagon Note Lettre wagon CUV <input type="checkbox"/></p>		<p>40 41 42 43 44 45 46 47</p>	
<p>1 Consignor (name, address) - Expéditeur (nom, adresse)</p> <p>Signature</p> <p>VAT no. N° TVA</p>		<p>2</p> <p>3</p> <p>E-Mail</p> <p>Tel.</p> <p>Fax</p>		<p>7 Consignor's declarations Déclarations de l'expéditeur</p>		<p>8 Consignor's reference - Référence expéditeur</p>	
<p>4 Consignee (name, address, country) Destinataire (nom, adresse, pays)</p> <p>VAT no. N° TVA</p>		<p>5</p> <p>6</p> <p>E-Mail</p> <p>Tel.</p> <p>Fax</p>		<p>9 Documents attached - Annexes</p>		<p>16 Acceptance Prise en charge month - day - hour mois - jour - heure</p> <p>17</p>	
<p>10 Delivery point Lieu de livraison</p> <p>11</p> <p>12</p>		<p>13 Station - Gare</p> <p>14 Country - Pays</p>		<p>18 Wagon no. - Wagon N°</p> <p>19 Section - Parcours by - par</p>		<p>20 Payment instructions Paielement des frais including - y compris up to - jusqu'à</p> <p><input type="checkbox"/> Carriage charges paid Franco de port</p> <p><input type="checkbox"/> Incoterms</p>	
<p>15 Commercial specification - Conditions commerciales</p>		<p>16 Information for the consignee - informations pour le destinataire</p>		<p>21 Description of the goods Désignation de la marchandise</p>		<p>22 Exceptional consignment Transport exceptionnel yes <input type="checkbox"/>/oui</p> <p>23 RID yes <input type="checkbox"/>/oui</p> <p>24 NIM code</p> <p>25 Mass (weight) Masse</p> <p>26 Declaration of value Déclaration de valeur Currency</p> <p>27 Interest in delivery Intérêt à la livraison Monnaie</p> <p>28 Cash on delivery Remboursement Currency</p> <p>48 Examination Vérification</p>	
<p>70 Section - Parcours</p> <p>71</p> <p>72</p> <p>73</p> <p>74</p> <p>75</p> <p>76</p> <p>77</p> <p>78</p>		<p>79 Charges - Frais</p>		<p>49 Prepayment coding - Code d'affranchissement</p> <p>50 Route - Itinéraires</p>		<p>29 Place and date completed - Lieu et date d'établissement</p>	
<p>51 Customs procedures - Opérations douanières</p>		<p>52 Charges note Bulletin d'affranchissement yes <input type="checkbox"/>/oui returned renvoyé month - day / mois - jour</p> <p>53 Notification of payment no. Avis d'encaissement N° returned renvoyé month - day / mois - jour</p> <p>54 Formal report no. Procès-verbal N° made out by établi par month - day / mois - jour</p> <p>55 Extension of transit time - Prolongation du délai de livraison Code form - du to - au place - lieu</p>		<p>56 Carrier's declarations - Déclarations du transporteur</p> <p>57 Other carriers - Autres transporteurs Name, address - Nom, adresse</p> <p>Section - Parcours</p> <p>Status Qualité</p>		<p>58 a) Contractual carrier - Transporteur contractuel</p> <p>Signature</p> <p>b) Simplified transit procedure for rail Procédure simplifiée de transit ferroviaire yes <input type="checkbox"/>/oui</p> <p>Code for the principal Code principal obligé</p> <p>59 Date of arrival - Date d'arrivée</p> <p>Arrival no. - Arrivage N°</p> <p>Duplicate invoice Souche d'expédition</p> <p>60 Made available Mise à disposition month - day - hour / mois - jour - heure</p> <p>61 Acknowledgement of receipt Quittance du destinataire</p> <p>62 Consignment number Identification de l'envoi</p> <p>Country - Pays</p> <p>Station - Gare</p> <p>Undertaking Entreprise</p> <p>Consign't no. Exp. N°</p>	

3.2 Wagon note for Combined Transport

To be completed by the combined transport operator or the customer/forwarding haulier
 À remplir par l'entreprise de transport combiné ou le client/remettant

Mark the box applicable with a cross – Désigner par une croix ce qui convient
 (Boxes – Cases 20, 22, 23, 30, 52, 58)

<p>Notwithstanding any clause to the contrary, carriage of goods shall be subject to the CIM Uniform Rules. In addition, the carrier's General Terms and Conditions of Carriage shall apply. <i>Nonobstant toute clause contraire, le transport des marchandises est soumis aux Règles uniformes CIM. Sont en outre applicables les conditions générales de transport du transporteur.</i></p> <p>Except as otherwise agreed, the loading of empty wagons shall be subject to the CUV Uniform Rules. In addition the relevant contractual conditions of the railway undertaking shall apply. <i>Sauf convention contraire, l'achèvement des wagons vides est soumis aux Règles uniformes CUV. Sont en outre applicables les conditions contractuelles topiques de l'entreprise de transport ferroviaire.</i></p>		<p>30 CIM Consignment Note for Combined Transport Lettre de voiture CIM transport combiné</p>		<p>CUV Wagon Note for Combined Transport Lettre wagon CUV transport combiné</p>		<p>40 _____ 41 _____ 42 _____ 43 _____ 44 _____ 45 _____ 46 _____ 47 _____</p>	
<p>1 Consignor (name, address) – Expéditeur (nom, adresse)</p> <p>Signature</p> <p>VAT no. N° TVA</p>		<p>2 _____</p> <p>3 _____</p> <p>E-Mail</p> <p>Tel.</p> <p>Fax</p>		<p>7 Consignor's declarations Déclarations de l'expéditeur</p>		<p>8 Consignor's reference – Référence expéditeur</p>	
<p>4 Consignee (name, address, country) Destinataire (nom, adresse, pays)</p> <p>VAT no. N° TVA</p>		<p>5 _____</p> <p>6 _____</p> <p>E-Mail</p> <p>Tel.</p> <p>Fax</p>		<p>9 Documents attached – Annexes</p>			
<p>10 Delivery point Lieu de livraison</p>		<p>11 _____</p>		<p>12 _____</p>		<p>16 Acceptance Prise en charge</p> <p>month – day – hour mois – jour – heure</p>	
<p>13 Commercial specification – Conditions commerciales</p>		<p>14 _____</p>		<p>17 _____</p>		<p>18 Wagon no. – Wagon N°</p> <p>19 Section – Parcours by – par</p>	
<p>15 Information for the consignee – Informations pour le destinataire</p>		<p>20 Payment instructions Paiement des frais</p> <p>including – y compris up to – jusqu'à</p> <p><input type="checkbox"/> Carriage charges paid Franco de port</p> <p><input type="checkbox"/> Incoterms</p>		<p>21 No UTI/Type UTI/Length UTI/Net mass (weight)/Tare UTI/Description of the goods N° UTI/Type UTI/Longueur UTI/Masse nette/Tare UTI/Désignation de la marchandise</p> <p>UTI 1 Seal nos – Scellés N° Reference – Référence</p>		<p>22 Exceptional consignment Transport exceptionnel yes oui <input type="checkbox"/></p> <p>23 RID yes oui <input type="checkbox"/></p> <p>24 NHM Code UTI 1</p> <p>NHM Code UTI 2</p> <p>25 Gross mass (weight) UTI 1</p> <p>Masse brute UTI 2</p> <p>26 Declaration of value Déclaration de valeur</p> <p>Currency</p> <p>27 Interest in delivery Intérêt à la livraison</p> <p>Monnaie</p> <p>28 Cash on delivery Remboursement</p> <p>Currency</p>	
<p>No UTI/Type UTI/Length UTI/Net mass (weight)/Tare UTI/Description of the goods N° UTI/Type UTI/Longueur UTI/Masse nette/Tare UTI/Désignation de la marchandise</p> <p>UTI 2 Seal nos – Scellés N° Reference – Référence</p>		<p>99 Customs endorsements Indications douanières</p>		<p>48 Examination Vérification</p>		<p>by – par</p>	
<p>70 Section Parcours</p>		<p>71 _____</p> <p>72 _____</p> <p>73 _____</p>		<p>74 _____</p> <p>75 _____</p>		<p>76 _____</p> <p>77 _____</p> <p>78 _____</p>	
<p>79 Charges</p>		<p>80 _____</p>		<p>81 _____</p>		<p>49 Prepayment coding – Code d'affranchissement</p> <p>50 Route – Itinéraires</p>	
<p>70 Section Parcours</p>		<p>71 _____</p> <p>72 _____</p> <p>73 _____</p>		<p>74 _____</p> <p>75 _____</p>		<p>76 _____</p> <p>77 _____</p> <p>78 _____</p>	
<p>79 Charges</p>		<p>80 _____</p>		<p>81 _____</p>		<p>51 Customs procedures – Opérations douanières</p>	
<p>70 Section Parcours</p>		<p>71 _____</p> <p>72 _____</p> <p>73 _____</p>		<p>74 _____</p> <p>75 _____</p>		<p>76 _____</p> <p>77 _____</p> <p>78 _____</p>	
<p>79 Charges</p>		<p>80 _____</p>		<p>81 _____</p>		<p>52 Charges note Bulletin d'affranchissement</p> <p>yes oui <input type="checkbox"/> returned renvoyé</p> <p>month – day mois – jour</p> <p>53 Notification of payment no. Avis d'encaissement N°</p> <p>returned renvoyé</p> <p>month – day mois – jour</p> <p>54 Formal report no. Procès-verbal N°</p> <p>made out by établi par</p> <p>month – day mois – jour</p> <p>55 Extension of transit time – Prolongation du délai de livraison</p> <p>Code from – du to – au place – lieu</p>	
<p>86 Carrier's declarations – Déclarations du transporteur</p>		<p>87 Other carriers – Autres transporteurs</p> <p>Name, address – Nom, adresse</p>		<p>Section – Parcours</p>		<p>Status Qualité</p>	
<p>88 a) Contractual carrier – Transporteur contractuel</p> <p>Signature</p>		<p>89 Date of arrival – Date d'arrivée</p> <p>Arrival no. – Arrivage N°</p>		<p>90 Made available Mise à disposition</p> <p>month – day – hour mois – jour – heure</p>		<p>91 Acknowledgement of receipt Quittance du destinataire</p>	
<p>b) Simplified transit procedure for rail Procédure simplifiée de transit ferroviaire</p> <p>yes oui <input type="checkbox"/></p> <p>Code for the principal Code principal obligé</p>		<p>Original</p>		<p>92 Consignment number Identification de l'envoi</p> <p>Country – Pays</p> <p>Station – Gare</p> <p>Undertaking Entreprise</p> <p>Consign't no. Exp. N°</p>		<p>93 Place and date completed – Lieu et date d'établissement</p>	
<p>Code for the principal Code principal obligé</p>		<p>1</p>		<p>Date, signature</p>		<p>© 2012 COT</p>	

To be completed by the combined transport operator or the customer/forwarding haulier
 À remplir par l'entreprise de transport combiné ou le client/remettant

Mark the box applicable with a cross – Désigner par une croix ce qui convient
 (Boxes – Cases 20, 22, 23, 30, 52, 58)

Notwithstanding any clause to the contrary, carriage of goods shall be subject to the CIM Uniform Rules. In addition, the carrier's General Terms and Conditions of Carriage shall apply. Nonobstant toute clause contraire, le transport des marchandises est soumis aux Règles uniformes CIM. Sont en outre applicables les conditions générales de transport du transporteur.		Except as otherwise agreed, the haulage of empty wagons shall be subject to the CUV Uniform Rules. In addition the relevant contractual conditions of the railway undertaking shall apply. Sauf convention contraire, l'acheminement des wagons vides est soumis aux Règles uniformes CUV. Sont en outre applicables les conditions contractuelles typiques de l'entreprise de transport ferroviaire.		Point 6.7.8	
30 CIM Consignment Note for Combined Transport Lettre de voiture CIM transport combiné		CUV Wagon Note for Combined Transport Lettre wagon CUV transport combiné		40 _____ 41 _____ 42 _____ 43 _____ 44 _____ 45 _____ 46 _____ 47 _____	
1 Consignor (name, address) – Expéditeur (nom, adresse) Signature VAT no. / N° TVA		2 _____ 3 _____ E-Mail Tel. Fax		7 Consignor's declarations Déclarations de l'expéditeur	
4 Consignee (name, address, country) Destinataire (nom, adresse, pays) Signature VAT no. / N° TVA		5 _____ 6 _____ E-Mail Tel. Fax		8 Consignor's reference – Référence expéditeur 9 Documents attached – Annexes	
10 Delivery point Lieu de livraison		11 _____ 12 _____		16 Acceptance Prise en charge month – day – hour / mois – jour – heure Point – Lieu	
Station – Gare Country – Pays		13 Commercial specification – Conditions commerciales 14 _____		18 Wagon no. – Wagon N° 19 Section – Parcours by – par Sectional invoicing / Facturation transit	
15 Information for the consignee – Informations pour le destinataire		20 Payment instructions Paiement des frais including – y compris up to – jusqu'à <input type="checkbox"/> Carriage charges paid / Franco de port <input type="checkbox"/> Incoterms		26 Declaration of value Déclaration de valeur Currency / Monnaie 27 Interest in delivery Intérêt à la livraison Monnaie 28 Cash on delivery Remboursement Currency / Monnaie	
21 No UTI / Type UTI / Length UTI / Net mass (weight) / Tare UTI / Description of the goods N° UTI / Type UTI / Longueur UTI / Masse nette / Tare UTI / Désignation de la marchandise UTI 1 Seal nos – Scellés N° Reference – Référence		22 Exceptional consignment Transport exceptionnel yes / oui <input type="checkbox"/> 23 RID yes / oui <input type="checkbox"/> 24 NHM Code UTI 1 NHM Code UTI 2		25 Gross mass (weight) UTI 1 Masse brute UTI 2 Total 26 Declaration of value Déclaration de valeur Currency / Monnaie 27 Interest in delivery Intérêt à la livraison Monnaie 28 Cash on delivery Remboursement Currency / Monnaie	
No UTI / Type UTI / Length UTI / Net mass (weight) / Tare UTI / Description of the goods N° UTI / Type UTI / Longueur UTI / Masse nette / Tare UTI / Désignation de la marchandise UTI 2 Seal nos – Scellés N° Reference – Référence		RID yes / oui <input type="checkbox"/> 99 Customs endorsemments Indications douanières		48 Examination Vérification by – par	
70 Section Parcours 71 _____ 72 _____ 73 _____ 74 _____ 75 _____ 76 _____ 77 _____ 78 _____ 79 Charges / Frais		49 Prepayment coding – Code d'affranchissement 50 Route – Itinéraires		51 Customs procedures – Opérations douanières	
70 Section Parcours 71 _____ 72 _____ 73 _____ 74 _____ 75 _____ 76 _____ 77 _____ 78 _____ 79 Charges / Frais		52 Charges note Bulletin d'affranchissement yes / oui <input type="checkbox"/> returned / renvoyé month – day / mois – jour		53 Notification of payment no. Avis d'encaissement N° returned / renvoyé month – day / mois – jour	
70 Section Parcours 71 _____ 72 _____ 73 _____ 74 _____ 75 _____ 76 _____ 77 _____ 78 _____ 79 Charges / Frais		54 Formal report no. Procès-verbal N° made out by / établi par month – day / mois – jour		55 Extension of transit time – Prolongation du délai de livraison Code from – du to – au place – lieu	
56 Carrier's declarations – Déclarations du transporteur		57 Other carriers – Autres transporteurs Name, address – Nom, adresse Section – Parcours Status / Qualité		60 Made available Mise à disposition month – day – hour / mois – jour – heure 61 Acknowledgement of receipt Quittance du destinataire	
58 a) Contractual carrier – Transporteur contractuel Signature		59 Date of arrival – Date d'arrivée Arrival no. – Arrivage N° Invoice / Feuille de route		62 Consignment number Identification de l'envoi Country – Pays Station – Gare Undertaking / Entreprise Consigt' no. / Exp. N°	
b) Simplified transit procedure for rail Procédure simplifiée de transit ferroviaire yes / oui <input type="checkbox"/> Code for the principal Code principal obligé		29 Place and date completed – Lieu et date d'établissement		2	

Invoice
Feuille de route

2

Charging sections (continued) – Sections de taxation (suite)				Charges paid – Franco		To pay – Port dû		
				Invoicing currency Monnaie d'encaissement	Tariff currency Monnaie du tarif	Tariff currency Monnaie du tarif	Invoicing currency Monnaie d'encaissement	
				Cash on delivery (brought forward from the front) Remboursement (Rapport du recto)				80
								86 Ex. Rate
								90
				81	82			
				83 Cours	84	85	86 Cours	
				87	88	89	90	
				81	82			
				83 Ex. Rate	84	85	86 Ex. Rate	
				87	88	89	90	
				81	82			
				83 Cours	84	85	86 Cours	
				87	88	89	90	
				81	82			
				83 Ex. Rate	84	85	86 Ex. Rate	
				87	88	89	90	
				81	82			
				83 Cours	84	85	86 Cours	
				87	88	89	90	
				81	82			
				83 Ex. Rate	84	85	86 Ex. Rate	
				87	88	89	90	
				81	82			
				83 Cours	84	85	86 Cours	
				87	88	89	90	
				81	82			
				Brought forward from supplementary sheets Report des feuilles supplémentaires			92	
				Grand total – Montant général			94	

				A Charges		B Frais		C Charges	
				70	71	72	73	74	75
				76	77	78	79	80	81
				70	71	72	73	74	75
				76	77	78	79	80	81
				70	71	72	73	74	75
				76	77	78	79	80	81
				70	71	72	73	74	75
				76	77	78	79	80	81

To be completed by the combined transport operator or the customer/forwarding haulier
 À remplir par l'entreprise de transport combiné ou le client/remettant

Mark the box applicable with a cross – Désigner par une croix ce qui convient
 (Boxes – Cases 20, 22, 23, 30, 52, 58)

<p>Notwithstanding any clause to the contrary, carriage of goods shall be subject to the CIM Uniform Rules. In addition, the carrier's General Terms and Conditions of Carriage shall apply. Nonobstant toute clause contraire, le transport des marchandises est soumis aux Règles uniformes CIM. Sont en outre applicables les conditions générales de transport du transporteur.</p> <p>Except as otherwise agreed, the haulage of empty wagons shall be subject to the CUV Uniform Rules. In addition the relevant contractual conditions of the railway undertaking shall apply. Sauf convention contraire, l'acheminement des wagons vides est soumis aux Règles uniformes CUV. Sont en outre applicables les conditions contractuelles typiques de l'entreprise de transport ferroviaire.</p>		<p>30 CIM Consignment Note for Combined Transport Lettre de voiture CIM transport combiné</p>		<p>CUV Wagon Note for Combined Transport Lettre wagon CUV transport combiné</p>		<p>40 _____</p> <p>41 _____</p> <p>42 _____</p> <p>43 _____</p> <p>44 _____</p> <p>45 _____</p> <p>46 _____</p> <p>47 _____</p>	
<p>1 Consignor (name, address) – Expéditeur (nom, adresse)</p> <p>Signature</p> <p>VAT no. / N° TVA</p>		<p>2 _____</p> <p>3 _____</p> <p>E-Mail</p> <p>Tel.</p> <p>Fax</p>		<p>7 Consignor's declarations Déclarations de l'expéditeur</p>		<p>8 Consignor's reference – Référence expéditeur</p>	
<p>4 Consignee (name, address, country) Destinataire (nom, adresse, pays)</p> <p>VAT no. / N° TVA</p>		<p>5 _____</p> <p>6 _____</p> <p>E-Mail</p> <p>Tel.</p> <p>Fax</p>		<p>9 Documents attached – Annexes</p>			
<p>10 Delivery point Lieu de livraison</p>		<p>11 _____</p> <p>12 _____</p>		<p>16 Acceptance Prise en charge</p> <p>month – day – hour / mois – jour – heure</p>		<p>17 _____</p>	
<p>13 Commercial specification – Conditions commerciales</p>		<p>14 _____</p>		<p>18 Wagon no. – Wagon N°</p>		<p>19 Section – Parcours</p> <p>by – par</p>	
<p>15 Information for the consignee – Informations pour le destinataire</p>		<p>20 Payment instructions Paiement des frais</p> <p>including – y compris / up to – jusqu'à</p> <p><input type="checkbox"/> Carriage charges paid / Franco de port</p> <p><input type="checkbox"/> Incoterms</p>		<p>21 No UTI / Type UTI / Length UTI / Net mass (weight) / Tare UTI / Description of the goods N° UTI / Type UTI / Longueur UTI / Masse nette / Tare UTI / Désignation de la marchandise</p> <p>UTI 1 Seal nos – Scellés N°</p>		<p>22 Exceptional consignment Transport exceptionnel</p> <p>yes / oui <input type="checkbox"/></p>	
<p>23 RID</p> <p>yes / oui <input type="checkbox"/></p>		<p>24 NHM Code UTI 1</p> <p>NHM Code UTI 2</p>		<p>25 Gross mass (weight) UTI 1</p> <p>Masse brute UTI 2</p> <p>Total</p>		<p>26 Declaration of value Déclaration de valeur</p> <p>Currency / Monnaie</p> <p>27 Interest in delivery Intérêt à la livraison</p> <p>28 Cash on delivery Remboursement</p> <p>Currency / Monnaie</p>	
<p>No UTI / Type UTI / Length UTI / Net mass (weight) / Tare UTI / Description of the goods N° UTI / Type UTI / Longueur UTI / Masse nette / Tare UTI / Désignation de la marchandise</p> <p>UTI 2 Seal nos – Scellés N°</p>		<p>99 Customs endorsements Indications douanières</p> <p>RID yes / oui <input type="checkbox"/></p>		<p>48 Examination Vérification</p>		<p>by – par</p>	
<p>70 Section – Parcours</p> <p>71 _____</p> <p>72 _____</p> <p>73 _____</p> <p>74 _____</p> <p>75 _____</p>		<p>76 _____</p> <p>77 _____</p> <p>78 _____</p>		<p>79 Charges / Frais</p>		<p>49 Prepayment coding – Code d'affranchissement</p> <p>50 Route – Itinéraires</p>	
<p>80 a) Contractual carrier – Transporteur contractuel</p> <p>Signature</p>		<p>81 Customs procedures – Opérations douanières</p>		<p>82 Charges note Bulletin d'affranchissement</p> <p>yes / oui <input type="checkbox"/></p> <p>returned / renvoyé</p> <p>month – day / mois – jour</p>		<p>83 Notification of payment no. Avis d'encaissement N°</p> <p>returned / renvoyé</p> <p>month – day / mois – jour</p>	
<p>b) Simplified transit procedure for rail Procédure simplifiée de transit ferroviaire</p> <p>yes / oui <input type="checkbox"/></p> <p>Code for the principal Code principal obligé</p>		<p>84 Formal report no. Procès-verbal N°</p> <p>made out by / établi par</p> <p>month – day / mois – jour</p>		<p>85 Extension of transit time – Prolongation du délai de livraison</p> <p>Code from – du / to – au / place – lieu</p>		<p>86 Carrier's declarations – Déclarations du transporteur</p> <p>87 Other carriers – Autres transporteurs</p> <p>Name, address – Nom, adresse</p> <p>Section – Parcours</p> <p>Status / Qualité</p>	
<p>88 a) Contractual carrier – Transporteur contractuel</p> <p>Signature</p>		<p>89 Date of arrival – Date d'arrivée</p> <p>Arrival no. – Arrivage N°</p>		<p>90 Made available Mise à disposition</p> <p>month – day – hour / mois – jour – heure</p>		<p>91 Acknowledgement of receipt Quittance du destinataire</p>	
<p>92 Consignment number Identification de l'envoi</p> <p>Country – Pays</p> <p>Station – Gare</p> <p>Undertaking / Entreprise</p> <p>Consign't no. / Exp. N°</p>		<p>93 Place and date completed – Lieu et date d'établissement</p>		<p>3</p> <p>Date, signature</p>		<p>© 2012 COT</p>	

Arrival note/Customs
Bulletin d'arrivée/Douane

3

Charging sections (continued) – Sections de taxation (suite)				Charges paid – Franco		To pay – Port dû		
				Invoicing currency Monnaie d'encaissement	Tariff currency Monnaie du tarif	Tariff currency Monnaie du tarif	Invoicing currency Monnaie d'encaissement	
				Cash on delivery (brought forward from the front) Remboursement (Rapport du recto)				80
								86 Ex. Rate
								90
								81
								82
								83 Cours
								84
								85
								86 Cours
								87
								88
								89
								90
								81
								82
								83 Ex. Rate
								84
								85
								86 Ex. Rate
								87
								88
								89
								90
								81
								82
								83 Cours
								84
								85
								86 Cours
								87
								88
								89
								90
								81
								82
								83 Ex. Rate
								84
								85
								86 Ex. Rate
								87
								88
								89
								90
								81
								82
								83 Cours
								84
								85
								86 Cours
								87
								88
								89
								90
								91
								92
								93
								94

To be completed by the combined transport operator or the customer/forwarding haulier
 À remplir par l'entreprise de transport combiné ou le client/remettant

Mark the box applicable with a cross – Désigner par une croix ce qui convient
 (Boxes – Cases 20, 22, 23, 30, 52, 58)

<p>Notwithstanding any clause to the contrary, carriage of goods shall be subject to the CIM Uniform Rules. In addition, the carrier's General Terms and Conditions of Carriage shall apply. Nonobstant toute clause contraire, le transport des marchandises est soumis aux Règles uniformes CIM. Sont en outre applicables les conditions générales de transport du transporteur.</p> <p>Except as otherwise agreed, the haulage of empty wagons shall be subject to the CUV Uniform Rules. In addition the relevant contractual conditions of the railway undertaking shall apply. Sauf convention contraire, l'acheminement des wagons vides est soumis aux Règles uniformes CUV. Sont en outre applicables les conditions contractuelles typiques de l'entreprise de transport ferroviaire.</p>		<p>30 CIM Consignment Note for Combined Transport Lettre de voiture CIM transport combiné</p>		<p>CUV Wagon Note for Combined Transport Lettre wagon CUV transport combiné</p>		<p>40 _____</p> <p>41 _____</p> <p>42 _____</p> <p>43 _____</p> <p>44 _____</p> <p>45 _____</p> <p>46 _____</p> <p>47 _____</p>	
<p>1 Consignor (name, address) – Expéditeur (nom, adresse)</p> <p>Signature</p> <p>VAT no. / N° TVA</p>		<p>2 _____</p> <p>3 _____</p> <p>E-Mail</p> <p>Tel.</p> <p>Fax</p>		<p>7 Consignor's declarations Déclarations de l'expéditeur</p>		<p>8 Consignor's reference – Référence expéditeur</p>	
<p>4 Consignee (name, address, country) Destinataire (nom, adresse, pays)</p> <p>VAT no. / N° TVA</p>		<p>5 _____</p> <p>6 _____</p> <p>E-Mail</p> <p>Tel.</p> <p>Fax</p>		<p>9 Documents attached – Annexes</p>			
<p>10 Delivery point Lieu de livraison</p>		<p>11 _____</p> <p>12 _____</p>		<p>16 Acceptance Prise en charge</p> <p>month – day – hour / mois – jour – heure</p>		<p>17 _____</p>	
<p>13 Commercial specification – Conditions commerciales</p>		<p>14 _____</p>		<p>18 Wagon no. – Wagon N°</p>		<p>19 Section – Parcours</p> <p>by – par</p>	
<p>15 Information for the consignee – Informations pour le destinataire</p>				<p>20 Payment instructions Paiement des frais</p> <p>including – y compris / up to – jusqu'à</p> <p><input type="checkbox"/> Carriage charges paid / Franco de port</p> <p><input type="checkbox"/> Incoterms</p>			
<p>21 No UTI / Type UTI / Length UTI / Net mass (weight) / Tare UTI / Description of the goods N° UTI / Type UTI / Longueur UTI / Masse nette / Tare UTI / Désignation de la marchandise</p> <p>UTI 1 Seal nos – Scellés N°</p>		<p>22 Exceptional consignment Transport exceptionnel</p> <p>yes / oui <input type="checkbox"/></p>		<p>23 RID yes / oui <input type="checkbox"/></p>		<p>24 NHM Code UTI 1</p> <p>NHM Code UTI 2</p>	
<p>Reference – Référence</p>		<p>25 Gross mass (weight) UTI 1</p> <p>Masse brute UTI 2</p> <p>Total</p>		<p>26 Declaration of value Déclaration de valeur</p> <p>Currency / Monnaie</p>		<p>27 Interest in delivery Intérêt à la livraison</p> <p>Monnaie</p>	
<p>UTI 2 Seal nos – Scellés N°</p>		<p>Reference – Référence</p>		<p>99 Customs endorsements Indications douanières</p> <p>RID yes / oui <input type="checkbox"/></p>		<p>28 Cash on delivery Remboursement</p> <p>Currency</p>	
<p>70 Section – Parcours</p>		<p>71 _____</p> <p>72 _____</p> <p>73 _____</p> <p>74 _____</p> <p>75 _____</p>		<p>76 _____</p> <p>77 _____</p> <p>78 _____</p>		<p>79 Charges – Frais</p>	
<p>49 Prepayment coding – Code d'affranchissement</p>		<p>50 Route – Itinéraires</p>		<p>51 Customs procedures – Opérations douanières</p>		<p>52 Charges note Bulletin d'affranchissement</p> <p>yes / oui <input type="checkbox"/></p> <p>returned / renvoyé</p> <p>month – day / mois – jour</p>	
<p>53 Notification of payment no. Avis d'encaissement N°</p>		<p>54 Formal report no. Procès-verbal N°</p>		<p>55 Extension of transit time – Prolongation du délai de livraison</p> <p>Code from – du / to – au / place – lieu</p>		<p>56 Carrier's declarations – Déclarations du transporteur</p>	
<p>57 Other carriers – Autres transporteurs</p> <p>Name, address – Nom, adresse</p>		<p>58 _____</p>		<p>59 _____</p>		<p>Status / Qualité</p>	
<p>60 Made available Mise à disposition</p> <p>month – day – hour / mois – jour – heure</p>		<p>61 Acknowledgement of receipt Quittance du destinataire</p>		<p>62 Consignment number Identification de l'envoi</p> <p>Country – Pays</p> <p>Station – Gare</p> <p>Undertaking / Entreprise</p> <p>Consign't no. / Exp. N°</p>		<p>63 Place and date completed – Lieu et date d'établissement</p>	
<p>64 Contractual carrier – Transporteur contractuel</p> <p>Signature</p>		<p>65 Date of arrival – Date d'arrivée</p> <p>Arrival no. – Arrivage N°</p>		<p>66 _____</p>		<p>67 _____</p>	
<p>b) Simplified transit procedure for rail Procédure simplifiée de transit ferroviaire</p> <p>yes / oui <input type="checkbox"/></p> <p>Code for the principal Code principal obligé</p>		<p>Duplicate / Duplicata</p>		<p>4</p>		<p>Date, signature</p>	

Duplicate
Duplicata

4

Charging sections (continued) – Sections de taxation (suite)				Charges paid – Franco		To pay – Port dû		
				Invoicing currency Monnaie d'encaissement	Tariff currency Monnaie du tarif	Tariff currency Monnaie du tarif	Invoicing currency Monnaie d'encaissement	
				Cash on delivery (brought forward from the front) Remboursement (Report du recto)				80
								86 Ex. Rate
								90
								81
								82
				83 Cours	84	85	86 Cours	
								87
								81
								82
				83 Ex. Rate	84	85	86 Ex. Rate	
								87
								81
								82
				83 Cours	84	85	86 Cours	
								87
								81
								82
				83 Ex. Rate	84	85	86 Ex. Rate	
								87
								81
								82
				83 Cours	84	85	86 Cours	
								87
								81
								82
								91
								92
				Grand total – Montant général				94

D	70	Section Parcours			71	72	A Charges
	75		76		77	78	
E	70	Section Parcours			71	72	B Frais
	75		76		77	78	
F	70	Section Parcours			71	72	C Charges
	75		76		77	78	
G	70	Section Parcours			71	72	Frais
	75		76		77	78	

To be completed by the combined transport operator or the customer/forwarding haulier. À remplir par l'entreprise de transport combiné ou le client/remettant.

Mark the box applicable with a cross – Désigner par une croix ce qui convient (Boxes – Cases 20, 22, 23, 30, 52, 58)

<p>Notwithstanding any clause to the contrary, carriage of goods shall be subject to the CIM Uniform Rules. In addition, the carrier's General Terms and Conditions of Carriage shall apply. Nonobstant toute clause contraire, le transport des marchandises est soumis aux Règles uniformes CIM. Sont en outre applicables les conditions générales de transport du transporteur.</p> <p>Except as otherwise agreed, the haulage of empty wagons shall be subject to the CUV Uniform Rules. In addition the relevant contractual conditions of the railway undertaking shall apply. Sauf convention contraire, l'acheminement des wagons vides est soumis aux Règles uniformes CUV. Sont en outre applicables les conditions contractuelles typiques de l'entreprise de transport ferroviaire.</p>		<p>30 CIM Consignment Note for Combined Transport Lettre de voiture CIM transport combiné</p>		<p>CUV Wagon Note for Combined Transport Lettre wagon CUV transport combiné</p>		<p>40</p>		<p>41</p>		<p>42</p>		<p>43</p>											
<p>1 Consignor (name, address) – Expéditeur (nom, adresse)</p> <p>Signature</p> <p>VAT no. / N° TVA</p>		<p>2</p> <p>3</p> <p>E-Mail</p> <p>Tel.</p> <p>Fax</p>		<p>7 Consignor's declarations Déclarations de l'expéditeur</p>		<p>8 Consignor's reference – Référence expéditeur</p>																	
<p>4 Consignee (name, address, country) Destinataire (nom, adresse, pays)</p> <p>VAT no. / N° TVA</p>		<p>5</p> <p>6</p> <p>E-Mail</p> <p>Tel.</p> <p>Fax</p>		<p>9 Documents attached – Annexes</p>																			
<p>10 Delivery point Lieu de livraison</p>		<p>11</p>		<p>12</p>		<p>16 Acceptance Prise en charge</p> <p>month – day – hour / mois – jour – heure</p>		<p>17</p>															
<p>Station – Gare</p>		<p>Country – Pays</p>		<p>18 Wagon no. – Wagon N°</p>		<p>19 Section – Parcours</p> <p>by – par</p>																	
<p>13 Commercial specification – Conditions commerciales</p>		<p>14</p>																					
<p>15 Information for the consignee – Informations pour le destinataire</p>						<p>20 Payment instructions Paiement des frais</p> <p>including – y compris / up to – jusqu'à</p> <p><input type="checkbox"/> Carriage charges paid Franco de port</p> <p><input type="checkbox"/> Incoterms</p>																	
<p>21 No UTI / Type UTI / Length UTI / Net mass (weight) / Tare UTI / Description of the goods N° UTI / Type UTI / Longueur UTI / Masse nette / Tare UTI / Désignation de la marchandise</p> <p>UTI 1 Seal nos – Scellés N°</p>		<p>22 Exceptional consignment Transport exceptionnel</p> <p>yes / oui <input type="checkbox"/></p>		<p>23 RID</p> <p>yes / oui <input type="checkbox"/></p>		<p>24 NHM Code UTI 1</p> <p>NHM Code UTI 2</p>		<p>25 Gross mass (weight) UTI 1</p> <p>Masse brute UTI 2</p> <p>Total</p>		<p>26 Declaration of value Déclaration de valeur</p> <p>Currency / Monnaie</p>		<p>27 Interest in delivery Intérêt à la livraison</p> <p>Monnaie</p>		<p>28 Cash on delivery Remboursement</p> <p>Currency</p>									
<p>No UTI / Type UTI / Length UTI / Net mass (weight) / Tare UTI / Description of the goods N° UTI / Type UTI / Longueur UTI / Masse nette / Tare UTI / Désignation de la marchandise</p> <p>UTI 2 Seal nos – Scellés N°</p>		<p>Reference – Référence</p>		<p>99 Customs endorsements Indications douanières</p> <p>RID yes / oui <input type="checkbox"/></p>								<p>48 Examination Vérification</p>											
<p>70 Section – Parcours</p>		<p>71</p>		<p>72</p>		<p>73</p>		<p>74</p>		<p>75</p>		<p>76</p>		<p>77</p>		<p>78</p>		<p>79 Charges – Frais</p>		<p>49 Prepayment coding – Code d'affranchissement</p>		<p>50 Route – Itinéraires</p>	
<p>70 Section – Parcours</p>		<p>71</p>		<p>72</p>		<p>73</p>		<p>74</p>		<p>75</p>		<p>76</p>		<p>77</p>		<p>78</p>		<p>79 Charges – Frais</p>		<p>51 Customs procedures – Opérations douanières</p>		<p>52 Charges note Bulletin d'affranchissement</p> <p>yes / oui <input type="checkbox"/></p> <p>returned / renvoyé</p> <p>month – day / mois – jour</p>	
<p>70 Section – Parcours</p>		<p>71</p>		<p>72</p>		<p>73</p>		<p>74</p>		<p>75</p>		<p>76</p>		<p>77</p>		<p>78</p>		<p>79 Charges – Frais</p>		<p>53 Notification of payment no. Avis d'encaissement N°</p> <p>returned / renvoyé</p> <p>month – day / mois – jour</p>		<p>54 Formal report no. Procès-verbal N°</p> <p>made out by / établi par</p> <p>month – day / mois – jour</p>	
<p>70 Section – Parcours</p>		<p>71</p>		<p>72</p>		<p>73</p>		<p>74</p>		<p>75</p>		<p>76</p>		<p>77</p>		<p>78</p>		<p>79 Charges – Frais</p>		<p>55 Extension of transit time – Prolongation du délai de livraison</p> <p>Code from – du / to – au / place – lieu</p>			
<p>56 Carrier's declarations – Déclarations du transporteur</p>		<p>57 Other carriers – Autres transporteurs</p> <p>Name, address – Nom, adresse</p>		<p>Section – Parcours</p>		<p>Status Qualité</p>																	
<p>58 a) Contractual carrier – Transporteur contractuel</p> <p>Signature</p>		<p>59 Date of arrival – Date d'arrivée</p> <p>Arrival no. – Arrivage N°</p>		<p>60 Made available Mise à disposition</p> <p>month – day – hour / mois – jour – heure</p>		<p>61 Acknowledgement of receipt Quittance du destinataire</p>		<p>62 Consignment number Identification de l'envoi</p> <p>Country – Pays</p> <p>Station – Gare</p> <p>Undertaking Entreprise</p> <p>Consign't no. Exp. N°</p>															
<p>b) Simplified transit procedure for rail Procédure simplifiée de transit ferroviaire</p> <p>yes / oui <input type="checkbox"/></p> <p>Code for the principal Code principal obligé</p>		<p>Duplicate invoice Souche d'expédition</p>		<p>5</p>		<p>Date, signature</p>		<p>29 Place and date completed – Lieu et date d'établissement</p>															

Duplicate invoice
Souche d'expédition

5

Charging sections (continued) – Sections de taxation (suite)				Charges paid – Franco		To pay – Port dû		
				Invoicing currency Monnaie d'encaissement	Tariff currency Monnaie du tarif	Tariff currency Monnaie du tarif	Invoicing currency Monnaie d'encaissement	
				Cash on delivery (brought forward from the front) Remboursement (Report du recto)				80
								86 Ex. Rate
								90
								81
								82
				83 Cours	84	85	86 Cours	
				87	88	89	90	
								81
								82
				83 Ex. Rate	84	85	86 Ex. Rate	
				87	88	89	90	
								81
								82
				83 Cours	84	85	86 Cours	
				87	88	89	90	
								81
								82
				83 Ex. Rate	84	85	86 Ex. Rate	
				87	88	89	90	
								81
								82
				83 Cours	84	85	86 Cours	
				87	88	89	90	
								81
								82
				83 Ex. Rate	84	85	86 Ex. Rate	
				87	88	89	90	
								81
								82
				83 Cours	84	85	86 Cours	
				87	88	89	90	
								81
								82
				Brought forward from supplementary sheets Report des feuilles supplémentaires				92
				Grand total – Montant général				94

3.3 Charges note

20 Charges Note Bulletin d'affranchissement		Original		1		40		41		42		43		Point 12
1 Consignor (name, address) – Expéditeur (nom, adresse)		2		3		8 Consignor's reference – Référence expéditeur								
VAT no. N° TVA		E-Mail		Tel.		Fax		31 Documents attached – Annexes						
4 Consignee (name, address, country) Destinataire (nom, adresse, pays)		E-Mail		Tel.		Fax		16 Acceptance Prise en charge		month – day – hour mois – jour – heure				
VAT no. N° TVA		10 Delivery point Lieu de livraison		11		12		32 Amount deposited by consignor Somme déposée par l'expéditeur		Currency Monnaie				
Station – Gare		Country – Pays		33 Postal address for return Adresse postale pour le renvoi		18 Wagon no. – Wagon N°		19 Section – Parcours		by – par		Sectional invoicing Facturation tronçonnée		
21 Description of the goods Désignation de la marchandise		20 Payment instructions Paiement des frais		including – y compris		up to – jusqu'à		<input type="checkbox"/> Carriage charges paid <input type="checkbox"/> Franco de port <input type="checkbox"/> Incoterms						
		25 Mass (weight) – Masse				34 Exchange rate on forwarding Cours au départ								
70 Section Parcours		71		72		73		81		82		83 Cours		
75		76		77		78		84		85		86 Ex. Rate		
70 Section Parcours		71		72		73		81		82		83 Cours		
75		76		77		78		84		85		86 Ex. Rate		
70 Section Parcours		71		72		73		81		82		83 Cours		
75		76		77		78		84		85		86 Ex. Rate		
70 Section Parcours		71		72		73		81		82		83 Cours		
75		76		77		78		84		85		86 Ex. Rate		
35 Charges note initiated Etablissement du bulletin d'affranchissement		36 Return of the charges note Renvoi du bulletin d'affranchissement		37 Re-arrival of the charges note Rentrée du bulletin d'affranchissement		Total amount or to be carried forward Montant total ou à reporter		38		62 Consignment number Identification de l'envoi		Country – Pays		Station – Gare
										Undertaking Entreprise		Consign't no. Exp. N°		

Original of the charges note
Original du bulletin d'affranchissement

1

E	70	Section Parcours	71	72	73	Charges	81	82	83	Cours	
	75		76	77							78
F	70	Section Parcours	71	72	73	Frais	81	82	83	Ex. Rate	
	75		76	77							78
G	70	Section Parcours	71	72	73	Charges	81	82	83	Cours	
	75		76	77							78
H	70	Section Parcours	71	72	73	Frais	81	82	83	Ex. Rate	
	75		76	77							78
							Amount brought forward from front Report du rastro		82		
Total amount to be taken to account by the carrier Montant total à comptabiliser par le transporteur									85		
Amount deposited by consignor Somme déposée par l'expéditeur									86		
Amount to be refunded to the consignor Somme à restituer à l'expéditeur							87				
Amount to be collected from the consignor Somme à percevoir de l'expéditeur									88		

20 Charges Note Bulletin d'affranchissement		Accounting copy Bulletin comptable	2	40 44	41 45	42 46	43 47	Point 12			
1 Consignor (name, address) – Expéditeur (nom, adresse) VAT no. N° TVA		2 3 E-Mail Tel. Fax		8 Consignor's reference – Référence expéditeur							
4 Consignee (name, address, country) Destinataire (nom, adresse, pays) VAT no. N° TVA		E-Mail Tel. Fax		31 Documents attached – Annexes							
10 Delivery point Lieu de livraison		11 12		16 Acceptance Prise en charge month – day – hour mois – jour – heure		32 Amount deposited by consignor Somme déposée par l'expéditeur Currency Monnaie					
Station – Gare		Country – Pays		18 Wagon no. – Wagon N°		19 Section – Parcours by – par Sectional invoicing Facturation Transit					
23 Postal address for return Adresse postale pour le renvoi		20 Payment instructions Paiement des frais including – y compris up to – jusqu'à <input type="checkbox"/> Carriage charges paid Franco de port <input type="checkbox"/> Incoterms		21 Description of the goods Désignation de la marchandise				25 Mass (weight) – Masse		34 Exchange rate on forwarding Cours au départ	
70 Section Parcours		71 72 73 74 75 76 77 78		79 Charges Frais		81 84 85		83 Cours 87			
B 70 Section Parcours		71 72 73 74 75 76 77 78		79 Charges Frais		81 84 85		83 Ex. Rate 87			
C 70 Section Parcours		71 72 73 74 75 76 77 78		79 Charges Frais		81 84 85		83 Cours 87			
D 70 Section Parcours		71 72 73 74 75 76 77 78		79 Charges Frais		81 84 85		83 Ex. Rate 87			
35 Charges note initiated Etablissement du bulletin d'affranchissement		36 Return of the charges note Renvoi du bulletin d'affranchissement		37 Re-arrival of the charges note Rentrée du bulletin d'affranchissement		Total amount or to be carried forward Montant total ou à reporter		38 39 42 Consignment number Identification de l'envoi Country – Pays Station – Gare Undertaking Entreprise Consign't no. Exp. N°			

Accounting copy
Bulletin comptable

2

E	70	Section	71	72	73	Charges	81	82	83	Cours	
	75	Parcours	73	74							84
F	70	Section	71	72	73	Frais	81	82	83	Ex. Rate	
	75	Parcours	73	74							84
G	70	Section	71	72	73	Charges	81	82	83	Cours	
	75	Parcours	73	74							84
H	70	Section	71	72	73	Frais	81	82	83	Ex. Rate	
	75	Parcours	73	74							84
							Amount brought forward from front Report du rastro		82		
Total amount to be taken to account by the carrier Montant total à comptabiliser par le transporteur									85		
Amount deposited by consignor Somme déposée par l'expéditeur									86		
Amount to be refunded to the consignor Somme à restituer à l'expéditeur							87				
Amount to be collected from the consignor Somme à percevoir de l'expéditeur									88		

3 Audit copy / Bulletin de contrôle		40 41 42 43 44 45 46 47	Point 12																																																												
30 Charges Note / Bulletin d'affranchissement 1 Consignor (name, address) – Expéditeur (nom, adresse) 2 3 E-Mail Tel. Fax VAT no. / N° TVA 4 Consignee (name, address, country) / Destinataire (nom, adresse, pays) E-Mail Tel. Fax VAT no. / N° TVA		8 Consignor's reference – Référence expéditeur 31 Documents attached – Annexes																																																													
10 Delivery point / Lieu de livraison 11 12 Station – Gare Country – Pays 23 Postal address for return / Adresse postale pour le renvoi		16 Acceptance / Prise en charge month – day – hour / mois – jour – heure 22 Amount deposited by consignor / Somme déposée par l'expéditeur Currency / Monnaie 18 Wagon no. – Wagon N° 19 Section – Parcours by – par Sectional invoicing / Facturation Transit 20 Payment instructions / Paiement des frais including – y compris / up to – jusqu'à <input type="checkbox"/> Carriage charges paid / Franco de port <input type="checkbox"/> Incoterms																																																													
21 Description of the goods / Désignation de la marchandise		25 Mass (weight) – Masse 34 Exchange rate on forwarding / Cours au départ																																																													
<table border="1" style="width:100%; border-collapse: collapse;"> <tr> <td style="width: 5%;">70</td> <td style="width: 15%;">Section / Parcours</td> <td style="width: 15%;">71</td> <td style="width: 15%;">72</td> <td style="width: 15%;">73</td> <td style="width: 15%;">74</td> <td style="width: 15%;">75</td> <td style="width: 15%;">76</td> <td style="width: 15%;">77</td> <td style="width: 15%;">78</td> <td style="width: 15%;">79</td> <td style="width: 15%;">Charges / Frais</td> </tr> <tr> <td>A</td> <td></td> <td></td> <td></td> <td></td> <td></td> <td></td> <td></td> <td></td> <td></td> <td></td> <td></td> </tr> <tr> <td>B</td> <td></td> <td></td> <td></td> <td></td> <td></td> <td></td> <td></td> <td></td> <td></td> <td></td> <td></td> </tr> <tr> <td>C</td> <td></td> <td></td> <td></td> <td></td> <td></td> <td></td> <td></td> <td></td> <td></td> <td></td> <td></td> </tr> <tr> <td>D</td> <td></td> <td></td> <td></td> <td></td> <td></td> <td></td> <td></td> <td></td> <td></td> <td></td> <td></td> </tr> </table>		70	Section / Parcours	71	72	73	74	75	76	77	78	79	Charges / Frais	A												B												C												D												81 84 85 86 87 88 89 90 91 92 93 94 95 96 97 98 99	
70	Section / Parcours	71	72	73	74	75	76	77	78	79	Charges / Frais																																																				
A																																																															
B																																																															
C																																																															
D																																																															
25 Charges note initiated / Etablissement du bulletin d'affranchissement 26 Return of the charges note / Renvoi du bulletin d'affranchissement		27 Re-arrival of the charges note / Rentrée du bulletin d'affranchissement Total amount or to be carried forward / Montant total ou à reporter 30 32 Consignment number / Identification de l'envoi Country – Pays / Station – Gare Undertaking / Entreprise Consign't no. / Exp. N°																																																													

Audit copy
Bulletin de contrôle

3

E	70	Section	71	72	73	Charges	81	82	83	Cours	
	75	Parcours	76	77							78
F	70	Section	71	72	73	Frais	81	82	83	Ex. Rate	
	75	Parcours	76	77							78
G	70	Section	71	72	73	Charges	81	82	83	Cours	
	75	Parcours	76	77							78
H	70	Section	71	72	73	Frais	81	82	83	Ex. Rate	
	75	Parcours	76	77							78
							Amount brought forward from front Report du recto		82		
Total amount to be taken to account by the carrier Montant total à comptabiliser par le transporteur									85		
Amount deposited by consignor Somme déposée par l'expéditeur									86		
Amount to be refunded to the consignor Somme à restituer à l'expéditeur							87				
Amount to be collected from the consignor Somme à percevoir de l'expéditeur									88		

3.4 Subsequent orders

Subsequent orders – Ordre ultérieur

2013-01-01

CIT 7

Consignor (name, adresse) – Expéditeur (nom, adresse)	Consignment number – Identification de l’envoi <input type="checkbox"/> CIM Consignment Note Lettre de voiture CIM <input type="checkbox"/> CUV Wagon Note Lettre wagon CUV Country – Pays Station – Gare Undertaking Entreprise Consig’t no. Exp. N°														
Consignee (name, address, country) – Destinataire (nom, adresse, pays)	Acceptance, point, date – Prise en charge, lieu, date month – day – hour mois – jour – heure														
Delivery point – Lieu de livraison	Wagon no./No. UTI – Wagon N°/N° de l’UTI														
Station – Gare Country – Pays															
Postal address of the carrier – Adresse postale du transporteur	Address of the carrier to carry out the instructions Adresse du transporteur chargé de l’exécution des ordres														
Instructions – Ordre – Mark the box applicable with a cross ☒ – Attach the duplicate of the consignment note – Mettre une ☒ dans la case en regard de la modification demandée – Joindre le duplicata de la lettre de voiture <table border="1"> <thead> <tr> <th>Code</th> <th>Amendment – Modification</th> </tr> </thead> <tbody> <tr> <td><input type="checkbox"/> 1</td> <td>Hold en route to await subsequent orders Arrêt en cours de route en attendant des ordres ultérieurs</td> </tr> <tr> <td><input type="checkbox"/> 2</td> <td>Postpone delivery to await subsequent orders Ajournement de la livraison en attendant des ordres ultérieurs</td> </tr> <tr> <td><input type="checkbox"/> 3</td> <td>Deliver to... (name, address, e-mail address or telephone or fax no.) at the delivery point Livraison au lieu de destination à... (nom, adresse, adresse e-mail ou numéro de téléphone ou de télécopieur)</td> </tr> <tr> <td><input type="checkbox"/> 4</td> <td>Forward to... (delivery point) for... (name, address, e-mail address or telephone or fax no.) via... (route) Expédition à... (lieu de livraison) à... (nom, adresse, pays, adresse e-mail ou numéro de téléphone ou de télécopieur) via... (itinéraire)</td> </tr> <tr> <td><input type="checkbox"/> 5¹</td> <td>Complete customs² and other administrative authorities’ formalities Accomplissement des formalités exigées par les douanes ou par d’autres autorités administratives <input type="checkbox"/> in my presence – en ma présence <input type="checkbox"/> in the presence of my representative – en présence de mon mandataire <input type="checkbox"/> I shall complete them – par mes soins <input type="checkbox"/> my agent will complete them² – par mon mandataire² <input type="checkbox"/> including payment of customs duties and other charges³ avec paiement des droits de douane et autres frais³ </td> </tr> <tr> <td><input type="checkbox"/> 6</td> <td>Other instructions Autre modification</td> </tr> </tbody> </table> Additional information for codes 3 to 6 Indications complémentaires relatives aux codes 3 – 6	Code	Amendment – Modification	<input type="checkbox"/> 1	Hold en route to await subsequent orders Arrêt en cours de route en attendant des ordres ultérieurs	<input type="checkbox"/> 2	Postpone delivery to await subsequent orders Ajournement de la livraison en attendant des ordres ultérieurs	<input type="checkbox"/> 3	Deliver to... (name, address, e-mail address or telephone or fax no.) at the delivery point Livraison au lieu de destination à... (nom, adresse, adresse e-mail ou numéro de téléphone ou de télécopieur)	<input type="checkbox"/> 4	Forward to... (delivery point) for... (name, address, e-mail address or telephone or fax no.) via... (route) Expédition à... (lieu de livraison) à... (nom, adresse, pays, adresse e-mail ou numéro de téléphone ou de télécopieur) via... (itinéraire)	<input type="checkbox"/> 5 ¹	Complete customs ² and other administrative authorities’ formalities Accomplissement des formalités exigées par les douanes ou par d’autres autorités administratives <input type="checkbox"/> in my presence – en ma présence <input type="checkbox"/> in the presence of my representative – en présence de mon mandataire <input type="checkbox"/> I shall complete them – par mes soins <input type="checkbox"/> my agent will complete them ² – par mon mandataire ² <input type="checkbox"/> including payment of customs duties and other charges ³ avec paiement des droits de douane et autres frais ³	<input type="checkbox"/> 6	Other instructions Autre modification	Please carry out these subsequent orders in compliance with CIM Article 19 §§ 3–5. Nous vous prions d’exécuter les présents ordres ultérieurs dans les conditions prévues à l’article 19 §§ 3 à 5 CIM. <input type="checkbox"/> Agreement of customs office of departure given Accord donné par le bureau de douane de départ <input type="checkbox"/> Informing the customs office of departure not necessary Information du bureau de douane de départ non nécessaire Remarks – Remarques:
Code	Amendment – Modification														
<input type="checkbox"/> 1	Hold en route to await subsequent orders Arrêt en cours de route en attendant des ordres ultérieurs														
<input type="checkbox"/> 2	Postpone delivery to await subsequent orders Ajournement de la livraison en attendant des ordres ultérieurs														
<input type="checkbox"/> 3	Deliver to... (name, address, e-mail address or telephone or fax no.) at the delivery point Livraison au lieu de destination à... (nom, adresse, adresse e-mail ou numéro de téléphone ou de télécopieur)														
<input type="checkbox"/> 4	Forward to... (delivery point) for... (name, address, e-mail address or telephone or fax no.) via... (route) Expédition à... (lieu de livraison) à... (nom, adresse, pays, adresse e-mail ou numéro de téléphone ou de télécopieur) via... (itinéraire)														
<input type="checkbox"/> 5 ¹	Complete customs ² and other administrative authorities’ formalities Accomplissement des formalités exigées par les douanes ou par d’autres autorités administratives <input type="checkbox"/> in my presence – en ma présence <input type="checkbox"/> in the presence of my representative – en présence de mon mandataire <input type="checkbox"/> I shall complete them – par mes soins <input type="checkbox"/> my agent will complete them ² – par mon mandataire ² <input type="checkbox"/> including payment of customs duties and other charges ³ avec paiement des droits de douane et autres frais ³														
<input type="checkbox"/> 6	Other instructions Autre modification														
Place, date Lieu, date Signature of the consignor/consignee Signature de l’expéditeur/du destinataire	Place, date Lieu, date Signature of the carrier Signature du transporteur														

¹Only the consignee is authorised to give such orders – Seul le destinataire est autorisé à donner de tels ordres
²This order may only be given if the consignee is authorised to do so in accordance with CIM Article 15 § 4 b) – Cet ordre ne peut être donné que lorsque le destinataire y est autorisé en vertu de l’article 15 § 4 b) CIM
³This order may only be given if the consignee is authorised to do so in accordance with CIM Article 15 § 4 c) – Cet ordre ne peut être donné que lorsque le destinataire y est autorisé en vertu de l’article 15 § 4 c) CIM

© 2013 CIT

3.5 Notification of prevention of conveyance

Circumstances preventing carriage – Empêchement au transport

2013-01-01

CIT 8

Consignor (name, address) – Expéditeur (nom, adresse)	Consignment number – Identification de l’envoi <input type="checkbox"/> CIM Consignment Note Lettre de voiture CIM <input type="checkbox"/> CUV Wagon Note Lettre wagon CUV Country – Pays Station – Gare Undertaking Entreprise Consig’t no. Exp. N°
Consignee (name, address, country) – Destinataire (nom, adresse, pays)	Acceptance, point, date – Prise en charge, lieu, date month – day – hour mois – jour – heure
Delivery point – Lieu de livraison	Wagon no./No. UTI – Wagon N°/N° de l’UTI
Station – Gare Country – Pays	
Postal address of the carrier – Adresse postale du transporteur	Address of the carrier to carry out the instructions Adresse du transporteur chargé de l’exécution des instructions

Circumstances preventing carriage – Empêchement au transport

- A** The consignment detailed above has had to be stopped in because of
L’envoi susmentionné a dû être arrêté à par suite de
- B** The consignment cannot be sent by another route
L’envoi ne peut pas être acheminé par un autre itinéraire
- C** Rerouting, subject to extra charges, is possible via
L’envoi peut être acheminé contre paiement des frais supplémentaires via
- Please supply your instructions without delay. Please attach the duplicate of the consignment note if you ask to change the consignee or delivery point. The consignment will be forwarded to its delivery point without waiting for your instructions if the circumstances preventing carriage are resolved before the instructions arrive. See CIM Article 22 § 1 for charges. For consignments which cannot be forwarded see CIM Article 22 §§ 2 – 6.
- Vous êtes prié de faire connaître vos instructions sans retard et d’y joindre le duplicata de la lettre de voiture si vous demandez une modification du destinataire ou du lieu de livraison. L’envoi sera acheminé sur son lieu de livraison, sans attendre vos instructions, si l’empêchement au transport vient à cesser avant l’arrivée de ces instructions. S’agissant des frais, voir art. 22 § 1 CIM. Pour les envois en souffrance, voir art. 22 §§ 2 – 6 CIM.

Instructions

Mark the box applicable with a cross [X] – Mettre une [X] dans la case code en regard de l’instruction demandée

Code	Instructions
<input type="checkbox"/> 1	Return to the consignor at the forwarding point Renvoi à l’expéditeur au lieu d’expédition
<input type="checkbox"/> 2	Forward to the delivery point when the circumstances preventing carriage are resolved A acheminer sur le lieu de livraison, dès que l’empêchement au transport aura cessé
<input type="checkbox"/> 3	Sell the goods A vendre
<input type="checkbox"/> 4	Forward to... (delivery point) for... (name, address, e-mail address or telephone or fax no.) via... (route) A livrer à... (lieu de livraison) à... (nom, adresse, pays, adresse e-mail ou numéro de téléphone ou de télécopieur) via... (itinéraire)
<input type="checkbox"/> 5	Take the following action (other instructions):... A traiter comme suit (autres instructions):...

Additional information for codes 1 to 5
Indications complémentaires relatives aux codes 1 à 5

Action taken on the instructions – Traitement des instructions

- The amendments have been copied to the duplicate of the consignment note which has been produced by the person entitled
Les modifications ont été reproduites sur le duplicata de la lettre de voiture, qui a été présenté par l’ayant droit
- Agreement of customs office of departure given
Accord donné par le bureau de douane de départ
- Informing the customs office of departure not necessary
Information du bureau de douane de départ non nécessaire

Place, date Lieu, date	Signature of the consignor/consignee Signature de l’expéditeur/du destinataire	Place, date Lieu, date	Signature of the carrier Signature du transporteur
---------------------------	---	---------------------------	---

© 2013 CIT

3.6 Notification of prevention of handover

Circumstances preventing delivery – Empêchement à la livraison

2013-01-01

CIT 9

Consignor (name, address) – Expéditeur (nom, adresse)	Consignment number – Identification de l’envoi <input type="checkbox"/> CIM Consignment Note Lettre de voiture CIM <input type="checkbox"/> CUV Wagon Note Lettre wagon CUV			Country – Pays <input type="text"/> Undertaking Entreprise <input type="text"/>	Station – Gare <input type="text"/> Consig'nt no. Exp. N° <input type="text"/>
Consignee (name, address, country) – Destinataire (nom, adresse, pays)	Acceptance, point, date – Prise en charge, lieu, date <div style="text-align: right;"> month – day – hour mois – jour – heure <input type="text"/> </div>				
Delivery point – Lieu de livraison	Wagon no./No. UTI – Wagon N°/N° de l’UTI				
Station – Gare	Country – Pays				
Postal address of the carrier – Adresse postale du transporteur					

Circumstances preventing delivery – Empêchement à la livraison

- The consignment detailed above cannot be delivered because: – L’envoi susmentionné n’a pas pu être livré pour les raisons suivantes:
- | | |
|--|---|
| <p>A Consignee refuses goods because – Le destinataire refuse l’envoi</p> <ul style="list-style-type: none"> <input type="checkbox"/> not ordered – pour ne pas l’avoir commandé <input type="checkbox"/> damaged – par suite d’avarie <input type="checkbox"/> deteriorated – par suite de détérioration spontanée <input type="checkbox"/> delayed arrival – par suite d’arrivée tardive <p>B Consignee refuses to pay – Le destinataire refuse le paiement</p> <ul style="list-style-type: none"> <input type="checkbox"/> carriage charges – du prix du transport <input type="checkbox"/> customs duties – des droits de douane <input type="checkbox"/> cash on delivery – du remboursement | <p>C Consignee hasn’t come forward despite being notified
Le destinataire ne se présente pas, malgré l’avis qui lui a été adressé</p> <p>D Consignee cannot be contacted
Le destinataire ne peut pas être atteint</p> <p>E Other reasons:…
Autres motifs:…</p> |
|--|---|

Please supply your instructions without delay. Please attach the duplicate of the consignment note except where the consignee has refused the consignment. The consignment will be delivered to the consignee without waiting for your instructions if the circumstances preventing delivery are resolved before the instructions arrive. See CIM Article 22 § 1 for charges, for consignments which cannot be forwarded see CIM Article 22 §§ 2 – 6.
 Vous êtes prié de faire connaître vos instructions, sans retard, et d’y joindre le duplicata de la lettre de voiture, sauf si le destinataire a refusé l’envoi. L’envoi sera livré au destinataire si l’empêchement à la livraison vient à cesser avant l’arrivée de vos instructions. S’agissant des frais, voir art. 22 § 1 CIM. Pour les envois en souffrance, voir art. 22 §§ 2 – 6 CIM.

Instructions

Mark the box applicable with a cross [X] – Mettre une [X] dans la case code en regard de l’instruction demandée

Code	Instructions
<input type="checkbox"/> 1	Re-attempt to deliver; if the circumstances preventing delivery reoccur, take the action shown in box... Présenter à nouveau l’envoi au destinataire; en cas de nouvel empêchement, l’envoi est à traiter selon chiffre...
<input type="checkbox"/> 2	Return to the consignor at the forwarding point Renvoi à l’expéditeur au lieu d’expédition
<input type="checkbox"/> 3	Sell the goods A vendre
<input type="checkbox"/> 4	Forward to... (delivery point) for... (name, address, e-mail address or telephone or fax no.) via... (route) A livrer à... (lieu de livraison) à... (nom, adresse, pays, adresse e-mail ou numéro de téléphone ou de télécopieur) via... (itinéraire)
<input type="checkbox"/> 5	Take the following action (other instructions):... A traiter comme suit (autres instructions):...

Additional information for codes 1 to 5
Indications complémentaires relatives aux codes 1 à 5

Action taken on the instructions – Traitement des instructions

- The amendments have been copied to the duplicate of the consignment note which has been produced by the person entitled
Les modifications ont été reproduites sur le duplicata de la lettre de voiture, qui a été présenté par l’ayant droit
- Agreement of customs office of departure given
Accord donné par le bureau de douane de départ
- Informing the customs office of departure not necessary
Information du bureau de douane de départ non nécessaire

Place, date Lieu, date	Signature of the consignor/consignee Signature de l’expéditeur/du destinataire	Place, date Lieu, date	Signature of the carrier Signature du transporteur
---------------------------	---	---------------------------	---

© 2013 CIT

APPENDIX 4 TO THE GENERAL CONTRACT OF USE

WAGON DAMAGE REPORT

This Appendix describes in more detail the information-related requirements laid out in article 18 to be applied upon the detection or presumption of loss or damage to a wagon.

In accordance with Article 18.1 GCU, the user RU has to send an electronic WDR to the wagon keeper for all wagons registered in the GCU database, by respecting the instructions given on the following pages of this guide.

The content of this WDR has to be sent as XML message, compliant with the GCU XSD schema. In case the user RU is not able to send the WDR as XML, the report must be created using the predefined GCU WDR PDF template as depicted hereafter. Own PDF templates or adaptations of the template must not be used. The XSD schema and the PDF template are available on the GCU website in their latest versions.

If a paper print-out is required, this has to comply with the GCU WDR PDF template.

If necessary, the user RU may attach photos, supplementary documents and information to the WDR.

The user RU has to conserve the WDR for the retention period set out in GCU article 33.

Should the user RU transfer a wagon to a third-party RU in accordance with GCU article 16, it remains responsible for establishing and submitting the complete WDR for the loss or damage occurred during the use by that third-party RU.

The GCU Bureau provides a communication platform (GCU Broker) to the signatories for transmission of the WDR, the use of which is compulsory.

The user RU which submits the WDR is informed by the communication platform if the wagon number is not found in the GCU database and therefore, the WDR is not forwarded to the keeper. In this case this user RU shall transmit the WDR by other ways in order to comply with its obligations stemming from article 17.

“Wagon Damage Report” (WDR)

WAGON DAMAGE REPORT

Ref: General Contract of Use (GCU) – article 18 & Appendix 4

1. General Information

User RU Report ID

Consignment n° Train n°

Place at which damage detected Damage detected on

Forwarding Station Destination Station

Date of Dispatch Loaded State Loaded Empty

Wagon number

Keeper

Keeper's address or e-mail address

2. Description of damage

Damage code as per GCU App. 9	Description of Damage
Damage 1 <input type="text"/> <input type="text"/> <input type="text"/> <input type="text"/> <input type="radio"/> New damage <input type="radio"/> Old damage	<input type="text"/>
Damage 2 <input type="text"/> <input type="text"/> <input type="text"/> <input type="text"/> <input type="radio"/> New damage <input type="radio"/> Old damage	<input type="text"/>
Damage 3 <input type="text"/> <input type="text"/> <input type="text"/> <input type="text"/> <input type="radio"/> New damage <input type="radio"/> Old damage	<input type="text"/>

Additional Remarks

An exact description of the damage will be produced during repairs and will be sent to the keeper.

3. Labels found on wagon

Sample K M I R1 U Date

RU that created labels found on wagon

4. Sample of Labeling

Sample K M I R1 U Wagon Detached Dispatch to Workshop Before unloading After unloading

5. Damage detected upon acceptance

GCU signatory RU Non-GCU signatory RU Connecting Railway

Company

6. Details of cause/perpetrator of damage

Wear and Tear

Impact damage in course of railway operations

Third Party Involved

Name Third Party

Address Third Party

Third Party's Signatory

Not ascertainable

Place/Date Contact

Attachments

Version 20180502 – 2018_TH_eWDR_pilot

Wagon Damage Report (WDR) WDR guide**Description of elements in the Wagon Damage Report**

Designation	Status	Description
User RU	Mandatory	Four characters organisation code (RICS) or alternatively name of the User RU
Report ID	Mandatory	User RU's unique Wagon Damage Report number. The number shall not exceed a maximum length of 32 characters.
Consignment n°	Mandatory	Consignment number for the movement concerned (as per consignment/wagon note). If the consignment number is unknown, enter "unknown".
Train n°	Conditional	Number of the train containing the wagon on which the damage was detected. If the train number is unknown, enter "unknown".
Place at which damage detected	Mandatory	Station/location name at which damage was detected. If the damage was not detected at a station, indicate the name or code of the nearest station/place.
Damage detected on	Mandatory	Date at which damage was detected (not necessarily the date on which the WDR was drawn up).
Forwarding Station	Mandatory	Name of departure station (as per consignment/wagon note). If the departure station is unknown, enter "unknown". In XML enter the CountryCodeISO = "XX" and for LocationSubsidiaryIdentification the DIUM Code "99999" with the name "unknown".
Destination Station	Mandatory	Name of destination station (as per consignment/wagon note). If the name of the destination station is unknown, enter "unknown". For information in XML see forwarding station.
Date of Dispatch	Mandatory	Date the consignment departed (as per consignment/wagon note). If the date of dispatch is unknown, the date when the damage was detected shall be used.
Loaded State	Mandatory	Loading status of wagon when damage was detected (loaded/empty).
Wagon number	Mandatory	Full 12-position wagon number, including check digit.
Keeper	Optional	Four characters organisation code (RICS) or alternatively name or VKM of the wagon keeper as marked on the wagon. As the allocation to the holder is made by the GCU Broker by means of the wagon number, it is not necessary to provide this information when dispatching via the GCU Broker.
Keeper's address or e-mail address	Optional	Additional information to prove to whom the WDR was sent by the RU.
Damage code as per GCU App. 9	Mandatory	Complete damage code in accordance with GCU Appendix 9, Annex 1.
New damage/ Old damage	Optional	Indicate whether the damage is newly detected or whether it was already present on the wagon.
Description of Damage	Mandatory	Designation in accordance with GCU Appendix 9, Annex 1.
Additional Remarks	Optional	Additional description/details of damages. Cause of damage, if this can be ascertained. Scale of the damage (e.g. 2 broken floorboards).
Label found on wagon	Conditional	Type of GCU labels present on the wagon. All present labels must be selected.
Date	Conditional	Date of found labels. Shall be indicated if present.
RU that created labels found on wagon	Conditional	Four characters organisation code (RICS) or alternatively name of the User RU that created labels found on the wagon.

Sample of Labelling	Mandatory	Type of GCU labels which have been affixed to the wagon. One or more relevant labels or alternatively "Wagon Detached" must be selected.
Dispatch to Workshop	Conditional	If the wagon has been dispatched to a workshop by the User RU (before or after unloading), this is to be indicated in accordance with GCU Article 19.
Damage detected upon acceptance	Conditional	Indication if the damage was detected at the place of handover. It shall be marked whether the company handing over the wagon is a GCU RU, a non-GCU RU, or a connecting railway (non-RU).
Company	Conditional	Four characters organisation code (RICS) or alternatively name of the company handed over the wagon.
Details of cause/ perpetrator of damage	Mandatory	Selection of one of the possible causes for the damage (wear and tear, impact damage in course of railway operation, third-party ¹ involved or not ascertainable). Only one cause may be given in all cases. If there is more than one cause, select "not possible to determine party responsible".
Place/Date	Mandatory	Location and date on which WDR was drawn up.
Contact	Mandatory	Contact details of User RU (name, telephone, email, etc.) for any queries concerning the WDR or damage.
Attachments	Conditional	Indication if any supporting documents are attached to the WDR (e.g. damage photos, documents, etc.).

¹The party responsible (third-party) must confirm in a separate document that it assumes liability in order that the RU can claim relief in accordance with GCU Article 22. This document is to be appended to the Wagon Damage Report.

APPENDIX 5 TO THE GENERAL CONTRACT OF USE

CALCULATING COMPENSATION FOR A WAGON OR BOGIE IN THE EVENT OF LOSS OR DAMAGE

I. Compensation

Compensation for loss or damage to a wagon is paid in line with the residual value of the wagon. The keeper decides which of the two following principles shall be applied for calculating compensation:

- A. specific residual value, justified by documentary proof of the actual damage sustained,
or
- B. flat-rate residual value.

A. Calculation of specific residual value

The keeper shall indicate the specific residual value and provide documentary proof of that value.

B. Calculation of flat-rate residual value

1. Calculation of replacement value

The replacement value is the average value of a new, similar or comparable wagon at the time the loss or damage occurred. The keeper shall provide documentary proof of the replacement value.

2. Calculation of compensation

- 2.1 The amount to be paid as compensation as per articles 19.2 or 20.3 of the GCU is calculated in accordance with points 2.2 or 2.3 hereafter. In addition, a flat-rate sum shall be paid as per point 2.4.
- 2.2 First of all 4% per year of service (linear rate) shall be deducted from the replacement value determined in accordance with point B1, up to a maximum rate of 80% of the replacement value (compensation option 1).
When calculating the number of years of service, the year of construction and the year when the wagon was damaged or lost are counted as a single year.
- 2.3 Should the keeper decide to keep the wagon, 10% shall be deducted from the amount to be paid as compensation calculated in accordance with point 2.2 (compensation option 2).
When the wagon is sent back to the keeper, the keeper may invoice the liable RU for the actual transport costs thus incurred, providing documentary proof of these costs. The amount to be invoiced as transport costs may not exceed 10% of the compensation payable as per point 2.3 (option 2).
- 2.4 A flat-rate sum of € 2000 shall be added to the compensation payable as per points 2.2 or 2.3 (amount payable for calculation by the keeper of compensation for loss or damage).

II. Compensation procedure

1. Loss

The keeper shall send to the RU an invoice complying with the principles laid out in point I, along with documentary proof that the wagon has been struck off the national vehicle register.

2. Damage

The keeper shall send to the RU an invoice complying with the principles laid out in point I.

On the invoice the keeper shall expressly state whether it wishes to transfer the wagon to the RU for scrapping or whether it wishes to keep the wagon. The RU must comply with that decision.

When the keeper has decided to transfer the wagon to the RU for scrapping, alongside the invoice it shall provide the RU with a document empowering the RU to scrap the wagon and collect any revenue arising thereby.

The RU is obliged to provide suitable documentary proof that wagon has been scrapped at the earliest possible date in order to allow the keeper to call for the wagon to be struck off the national vehicle register.

3. Persons acting for the parties

In this procedure the RU and keeper are represented by the individuals named in Appendix 1 to the GCU.

4. Customs formalities

The RU is obliged to handle any necessary customs formalities.

III. General rules

1. The aforementioned rules also apply to bogies.

2. All other rights and duties remain unaffected.

APPENDIX 6

TO THE GENERAL CONTRACT OF USE FOR WAGONS

I. COMPENSATION FOR LOSS OF USE

The compensation payable on the basis of Articles 13.3 (loss of use due to delay) and 23.2 (loss of use due to damage) of the GCU is calculated either based on the actual damage sustained or as a flat rate, whichever the keeper decides.

1. Compensation based on actual damage sustained

The keeper shall claim compensation for loss of use from the responsible RU by means of supporting documents on the basis of the damage sustained.

2. Flat-rate compensation

2.1 Daily rate per wagon in euros

To calculate the daily rate (in euros):

Multiply the coefficient for the relevant wagon type by the wagon's length over buffers (in metres, unrounded).

Code letters of various wagon types	Coefficient
E – Open Wagon	1.1
F – Open Wagon	1.5
G – Covered Wagon	1.1
H – Covered Wagon	1.5
I – Temperature-controlled wagon	1.4
K – Two-axle flat wagon	1.1
L – Flat wagon	1.5
O – Mixed flat open wagon	1.4
R – Bogie flat wagon	1.1
S – Bogie flat wagon	1.5
T – Wagon with opening roof	1.5
U – Special wagon	1.8
Z – Tank wagon	1.8

2.2 Flat-rate compensation to be paid for loss of use arising from the period for carriage being exceeded for empty or loaded wagons

The RU responsible for a loaded or empty wagon exceeding the carriage period shall pay the keeper a flat rate of compensation in accordance with 2.1 for each indivisible day of delay (Sundays and public holidays* not included), upon presentation by the keeper of an invoice.

For loaded wagons, this payment shall be independent of any compensation payable as a result of the loaded goods exceeding the transit period.

* according to the country in which the vehicle is located

2.3 Flat-rate compensation to be paid for loss of use arising from repair work on the wagon

The RU responsible for damaging a wagon or its accessories as per GCU Article 22 shall pay the keeper a flat rate of compensation upon presentation of an invoice in accordance with 2.1 for each indivisible (calendar) day on which the wagon is unavailable for use.

This compensation shall be calculated starting from the day following that on which the damage was first recorded (in accordance with GCU Appendix 4, Wagon damage report, "Damage detected on...") and shall end on the day on which the wagon's fitness for service is restored.

The loss-of-use period shall be suspended in the following cases:

- if the wagon is given a K label in the sense of GCU Appendix 9 and then takes more than two days to be taken to the workshop (a flat rate then applies for the time taken to reach the workshop);
- from the day the damage was recorded up to the day the goods are unloaded if the wagon has been given a K label before being forwarded;
- for the time elapsing between the request of spare parts as per Forms H and H^R and the delivery of these parts (GCU Article 23.2);
- if the wagon is taken for further maintenance work at the keeper's behest;
- if the wagon is given a K label (GCU Appendix 9) and transferred between two workshops and this takes more than two days (a flat rate then applies for the time taken to reach the other workshop).

2.4 Miscellaneous

The compensation payments referred to under points 2.2 and 2.3 may not be aggregated.

II. COMPENSATION FOR REPROFILING OF WHEELSETS

The RU responsible for damaging a wheelset to be reprofiled shall pay the keeper upon presentation of an invoice with supporting documents a flat rate of 350 EUR for the loss of value arising as a result of reprofiling (reduction in the running-circle diameter).

APPENDIX 7

TO THE GENERAL CONTRACT OF USE FOR WAGONS

SPARE PARTS

1. General principles

1.1 The management of spare parts must be organised in a cost-effective and rational manner to cut down on the time damaged wagons spend out of service and keep transport of the parts themselves to a minimum. The request for spare parts is to be made by means of Form H/H^R and should include the related damage report reference number.

Restrictions on transport conditions (e.g. opening hours, means of transport) are to be stated in advance on Form H/H^R.

1.2 The keeper must ensure that the requested spare parts are delivered to the workshop carrying out the repairs as rapidly as possible, or within 20 calendar days at the latest after forwarding the spare part request to the keeper. If this deadline is exceeded, the corresponding track occupation costs due to this delay can be invoiced to the keeper. Any track occupation costs must be indicated on the request for spare parts (Form H/H^R).

1.3 The user RU and the keeper shall designate a logistics centre to coordinate and steer all aspects of the provision of spare parts. The addresses shall be indicated in the list of addresses in Appendix 1 to the GCU.

1.4 Conditions for returning parts removed from vehicles are to be indicated by the keeper on Form H/H^R.

1.5 Modern means of communication (e.g. fax or e-mail) shall be used to exchange information.

1.6 When transporting spare parts, the most cost-effective means of transport and service shall be selected in terms of price, service, quality and transport time, taking account of specific delivery conditions.

1.7 Transport and customs related costs, regarding article 19 aren't included in the repair costs. These costs are to be charged to the responsible for the damage.

1.8 Spare parts shall be delivered ready for fitting and be compatible with the wagon to be repaired.

1.9 When sending spare parts, care must be paid to ensuring they can be clearly assigned to a given wagon on arrival. The consignee must use those parts on the designated wagons.

1.10 For transport beyond the borders of a customs area, the keeper must ensure customs clearance. This requirement is also applicable to the recovery (scrapping) or abandonment of parts outside of their own customs area.

Part A

Wheelsets

2. Principles

2.1 If wheelsets need to be repaired, the user RU must inform the wagon keeper without delay and at the latest within two working days (Saturdays excluded) of the damage being reported in the workshop, using Form H^R.

2.2 The user RU must offer the wagon keeper the procedure set out in point 3.1 and, where possible, the procedure set out in point 3.2.

2.3 The wagon keeper must accept one of both procedures on offer and send written agreement within two working days (Saturdays excluded). If the keeper does not answer within the period specified, the procedure in point 3.1 shall be applied.

3. Handling of wheelsets

3.1 Wheelsets replaced with wheelsets provided by the keeper

3.1.1 The user RU shall use Form H^R to notify the wagon keeper of the details of the wheelset (e.g. wheelset and housing type, diameter, wheelset position, wheelset number) and the delivery address for the wheelset to be supplied.

3.1.2 The keeper is to send the requested wheelset as swiftly as possible to the delivery address. It must provide the user RU with a delivery address for the damaged wheelset.

3.1.3 The wagon number must be indelibly marked on the damaged wheelset (inside of the wheel centre) once it has been removed.

3.1.4 The damaged wheelset must reach the keeper at the address provided as per 3.1.2 in Form H^R within 6 weeks of being removed from the wagon. If the wheelset does not reach the keeper by this time, he shall send out a reminder to the user RU, extending the deadline by a further 2 weeks at least. If the wheelset still does not arrive by this extended deadline, the user RU shall pay the keeper the replacement value of the wheelset.

3.2 Repair of wheelsets with keeper's approval

3.2.1 The damaged wheelset shall be removed and sent to an approved workshop for repair in accordance with the provisions of the keeper. Once repaired, the wheelset shall be fitted back on the wagon.

3.2.2 If during the repair operation on the damaged wheelset a technical defect is observed that requires the replacement of the wheel centre, axle or axle-box, the wagon keeper shall be informed immediately. The procedure in point 3.1 shall be applied from point 3.1.2 onwards.

Part B

Other interchangeable spare parts

4. Usage of spare parts of the user RU's

4.1 When wagon parts have been damaged, the user RU shall preferably replace them using interchangeable spare parts from its own stock. In principle, the spare parts should be of the same type as the removed parts or, if this is no longer available, as the other parts of the wagon. Mixing different designs is not permitted (unless stated otherwise in Appendix 10, e.g. brake blocks in accordance with 3.8.3).

The following are considered as interchangeable spare parts:

- Safety straps
- Cast iron brake blocks, as well as K and LL brake blocks, if marked on the wagon
- Brake couplings
- Spark arrestor plates
- Earthing braids. The earthing braids must comply with UIC Leaflet 533
- Screw couplers, factoring in breaking strength. The screw coupler must comply with EN 15566 and UIC Leaflet 520/IRS 50520 respectively
- Screw coupler suspension hooks
- Guiding and locking elements
- Steps and handles. The newly built steps must be of the exact same model to ensure that they remain within the loading gauge. The step surface must comply with UIC Leaflet 535-2 and/or EN 16116-2.
- Label holders, inscription plate
- Ventilation flaps, control gear, shutter retaining bracket
- Stanchions in accordance with UIC Leaflet 578
- End boards, crossing gangways

4.2 The value of any such interchangeable spare parts shall be included in the cost of the repair operation.

4.3 When the user RU makes a cost estimation to the keeper, the keeper must indicate whether he wishes the damaged parts to be returned to him at his own expense. If the keeper does not specify the return of these parts, they shall remain with the user RU, together with the other spare parts removed from the wagon. There shall be no form of compensation for the value of these parts.

5. Exceptional order for standard interchangeable spare parts

5.1 Due to the lack of interchangeable spare parts of the same type in the workshop and if these parts cannot be obtained quickly, interchangeable spare parts may be ordered from the keeper using an equivalent procedure to that in Part C (Form H).

5.2 This operation is coordinated exclusively through the logistics centres.

Part C

Other non-standard spare parts

6. Request for other non- interchangeable spare parts

6.1 The other spare parts that are needed to repair a wagon and are not stocked by the user RU shall be ordered from the keeper's logistics centre using Form H.

6.2 For each request for spare parts using Form H, confirmation of receipt shall be sent without delay to the logistics centre making the request. When confirming receipt, the estimated delivery time of the spare parts shall be indicated. If the damaged parts are to be returned, this should also be specified. If the spare parts cannot be dispatched immediately, the requesting logistics centre shall be informed without delay.

7. Return of other damaged non- interchangeable spare parts

7.1 Damaged parts with a low value (e.g. suspension rods and links, etc.) are not returned once removed. No compensation for their value shall take place.

7.2 Other damaged parts, once removed, shall only be returned at the keeper's request.

7.3 If the spare part does not arrive at its destination, the amount of compensation payable shall be subject to the provisions of the associated contract of carriage.

Part D

Fitting of spare parts from vehicles belonging to the same keeper

8.1 To avoid delaying the forwarding of a wagon, spare parts may be taken from another wagon of the same keeper, subject to his approval.

8.2 If the keeper has given his agreement, the spare parts must then be ordered for the wagon from which they have been taken.

Part E

TRANSPORT AND STORAGE OF PARTS

9. Principle

9.1 When wagon parts are transported, transhipped and stored before they are fitted to wagons, after their removal and in preparation for being sent back to the wagon keeper, particular care must be taken to ensure that their inner components remain undamaged and their surfaces and anti-corrosion coatings intact.

10. Wheelsets with axle boxes

10.1 Storage

- When stored side-by-side on the track, there must be no contact in the wheel profile area. Flange-to-flange contact is permissible.
- When stored in staggered formation (with double rail) there must be no contact between axle-box / flange or flange / axle shaft.
- When storing wheelsets in loading cradles, similar precautions must be taken.
- Storage on flat surfaces is permissible if the wheelsets are resting on suitable materials (wood, rubber, plastic) so that the surfaces in contact are not damaged.
- The wheelsets must be placed and moved in such a way that no damage can occur to the wheelset, its component parts as well as protection against corrosion.
- Wheelsets shall be secured against rolling away using wheel scotches, scotch blocks or hollow seats in the track.
- Stacking of wheelsets is permissible, if the above-mentioned provisions are applied for storage. Any axle-to-axle contact is forbidden.

Permissible example of storage



Photo 1: Storing on track using safety scotches





Photo 2: Storing in staggered formation on track using safety scotches



Photo 3: Storing in staggered formation (with double rail)





Photo 4: Storing in staggered formation on track with protections against contact

	
<p>Photo 5: Stacking of wheelsets in loading cradles</p>	<p>Photo 6: individual storage using lockers storage for single axles</p>
	
<p>Photo 7: Storing in staggered formation (with double rail) with spacers</p>	

10.2 Transport

- During transport by fork-lift truck, the tines of the fork and their ends must be fitted with protective padding. Damage resulting from wheelsets as well as protection against corrosion rolling off the forks should be prevented. Damage resulting from wheelsets rolling off the forks should be prevented.
- If load handling attachments are used, the wheelsets and protection against corrosion must not be damaged as a result.
- Wheelsets should be transported between workshops and spare parts centres in loading cradles wherever possible. The wheelsets must be loaded and secured in such a way that there is no possible damage to the wheelset with axle box, its component parts as well as protection against corrosion during transit. A tightening with straps passing on the axles shafts without protection is not permissible.

<p>Permissible example of handling</p>	
	
<p>Photo 1: Lifting device of crane for wheelsets with axle boxes (axle shaft.)</p>	<p>Photo 2: Lifting device of crane for wheelsets with axle boxes, release protective</p>

	
<p>Photo 3: Lifting device of crane for wheelsets (wheel disc)</p>	<p>Photo 4: Wheelset holder for fork-lift truck</p>
	
<p>Photo 5: Wheelset holder for fork-lift truck</p>	<p>Photo 6: Wheelset holder for fork-lift truck</p>
	
<p>Photo 7: Wheelset holder for fork-lift truck (loaded)</p>	<p>Photo 8: Wheelset holder for fork-lift truck (several wheelsets)</p>

11. Other parts

- Buffers shall be stored in such a way that no water is able to penetrate between the buffer casing and the plunger
- If leaf springs are transported directly by fork-lift truck, the tines of the fork and their ends must be fitted with protective padding (rubber inserts) to avoid damaging the anti-corrosion coating.

Issuing RU (LOGO)	Form H	No. 																								
Wagon number:	<div style="display: flex; gap: 10px;"> <div style="border: 1px solid black; width: 20px; height: 20px;"></div> <div style="border: 1px solid black; width: 20px; height: 20px;"></div> <div style="border: 1px solid black; width: 30px; height: 20px;"></div> <div style="border: 1px solid black; width: 30px; height: 20px;"></div> <div style="border: 1px solid black; width: 15px; height: 20px;"></div> </div>																									
Damage report reference number:	<div style="border: 1px solid black; height: 20px;"></div>																									
Keeper:	<div style="border: 1px solid black; height: 20px;"></div>	Fax no.: <div style="border: 1px solid black; width: 100px; height: 20px;"></div> E-mail: <div style="border: 1px solid black; width: 100px; height: 20px;"></div>																								
Description of parts:	<table border="1" style="width: 100%; border-collapse: collapse;"> <thead> <tr> <th style="width: 5%;">Pos</th> <th style="width: 15%;">Quantity</th> <th style="width: 60%;">Description</th> <th style="width: 20%;">*</th> </tr> </thead> <tbody> <tr><td style="text-align: center;">1</td><td></td><td></td><td></td></tr> <tr><td style="text-align: center;">2</td><td></td><td></td><td></td></tr> <tr><td style="text-align: center;">3</td><td></td><td></td><td></td></tr> <tr><td style="text-align: center;">4</td><td></td><td></td><td></td></tr> <tr><td style="text-align: center;">5</td><td></td><td></td><td></td></tr> </tbody> </table>		Pos	Quantity	Description	*	1				2				3				4				5			
Pos	Quantity	Description	*																							
1																										
2																										
3																										
4																										
5																										
Other:	* Parts missing from the wagon																									
Addresses:	Track occupation costs as per App. 7, point 1.2 Contact address: <div style="border: 1px solid black; height: 80px; width: 100%;"></div>	€ <div style="border: 1px solid black; width: 80px; height: 20px;"></div> Delivery address: <div style="border: 1px solid black; height: 60px; width: 100%;"></div> Delivery conditions, where appropriate: <div style="border: 1px solid black; height: 40px; width: 100%;"></div>																								
Date	<div style="border: 1px solid black; width: 100px; height: 20px;"></div>	Signature <div style="border: 1px solid black; width: 150px; height: 20px;"></div>																								
<small>To be filled in by the keeper</small>																										
Answer:	Estimated date of delivery: <div style="border: 1px solid black; width: 150px; height: 20px;"></div>																									
	Return of damaged parts? <input type="checkbox"/> Yes <input type="checkbox"/> No Pos. <div style="border: 1px solid black; width: 80px; height: 20px;"></div>																									
Address:	Delivery address: <div style="border: 1px solid black; height: 60px; width: 100%;"></div>	Delivery restrictions, where appropriate: <div style="border: 1px solid black; height: 60px; width: 100%;"></div>																								
Date:	<div style="border: 1px solid black; width: 100px; height: 20px;"></div>	Signature: <div style="border: 1px solid black; width: 150px; height: 20px;"></div> Company stamp: <div style="border: 1px solid black; width: 150px; height: 20px;"></div>																								
<small>Please use block letters throughout</small>		<small>Form H Page 1</small>																								

Type of U buffer	1)
75	<input type="checkbox"/>
105	<input type="checkbox"/>
105-A	<input type="checkbox"/>
105-B	<input type="checkbox"/>
105-C	<input type="checkbox"/>
150-L	<input type="checkbox"/>
Other type 2)	<input type="checkbox"/>

1) Put a cross in the corresponding box
2) Indicate buffer type

A	<input type="checkbox"/>
B	<input type="checkbox"/>
C	<input type="checkbox"/>
D	<input type="checkbox"/>
E	<input type="checkbox"/>

F -I	flat	<input type="checkbox"/>
F -II	convex r = 630	<input type="checkbox"/>
F -III	semi-convex r = 1500	<input type="checkbox"/>
F -IV	semi-convex r = 2750	<input type="checkbox"/>

A	<input type="checkbox"/>
B	<input type="checkbox"/>
C	<input type="checkbox"/>
D	<input type="checkbox"/>

E	<input type="checkbox"/>	
F	<input type="checkbox"/>	
N	Number of leaves	<input type="checkbox"/>
P	Without load	<input type="checkbox"/>

For wagons with rigid underframe

Yes No

Space for any additional drawings:

Form H Page 2

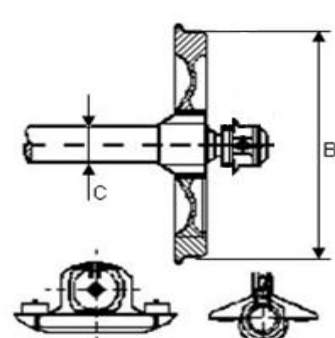
Issuing RU (LOGO)	<h1 style="margin: 0;">Form H^R</h1>		No. 			
Wagon number: - 		Drawn up on: _____				
Damage report reference number: 		Fax no.: email: 				
Keeper: 		Remarks: _____				
Condition of all the wheelsets of the wagon - for undamaged wheelset(s), complete only the fields "POS" and "B"						
Pos	T/M	B measured	C	Monobloc yes / no	Type of wheelset	Wheelset number(s) of damaged wheelset(s)
Pos: position of axle (as per marking on wagon). If no marking present, count from either end of wagon.						
Number of damaged wheelsets: 		Reason for withdrawal from service T/M: always indicate code opposite the axle number				
		1.2.2 Thermal overload 1.3.2 Wheel wear (tread) 1.3.3 Wheel flats 1.3.4 Metal inclusions 1.3.5 Cavities/exfoliation 1.5.1 Damage to wheel centre 1.6.1 Damage to axle 1.7.2 Out-of-round wheel			1.8.1.1 Axle box leaking 1.8.1.2 Loss of lubricant 1.8.3 Hot axle box 1.8.4 Wear plate displaced or missing 7.1.7 Overload (provide details) 8.1.1 Derailment Other:	
		Addresses: 				
Contact address: 		Delivery address: 			Station code: 	
Tel.: 		Delivery restrictions, if applicable: 			Fax: 	
Email: 		Quotes: see page 2				
Date: 		Signature: 			Company stamp: 	
Please complete in block letters						

Issuing RU (LOGO)	<h1>Form H^R</h1>
Wagon number:	<input style="width: 20px; height: 20px; border: 1px solid black;" type="text"/> <input style="width: 20px; height: 20px; border: 1px solid black;" type="text"/> <input style="width: 20px; height: 20px; border: 1px solid black;" type="text"/> <input style="width: 20px; height: 20px; border: 1px solid black;" type="text"/> <input style="width: 20px; height: 20px; border: 1px solid black;" type="text"/> <input style="width: 20px; height: 20px; border: 1px solid black;" type="text"/> <input style="width: 20px; height: 20px; border: 1px solid black;" type="text"/> <input style="width: 20px; height: 20px; border: 1px solid black;" type="text"/> <input style="width: 20px; height: 20px; border: 1px solid black;" type="text"/> <input style="width: 20px; height: 20px; border: 1px solid black;" type="text"/> <input style="width: 20px; height: 20px; border: 1px solid black;" type="text"/> <input style="width: 20px; height: 20px; border: 1px solid black;" type="text"/>
Damage report reference number:	<input style="width: 100%;" type="text"/>
Keeper:	<input style="width: 80%;" type="text"/> Fax no.: <input style="width: 150px;" type="text"/> Email: <input style="width: 150px;" type="text"/>
Quotes:	<p><input type="checkbox"/> 3.1 Request for replacement wheelset(s) using form H^R</p> <p><input type="checkbox"/> 3.2 Repair one or more wheelset(s) Repair to be done by approved depot <input style="width: 150px;" type="text"/></p> <p style="text-align: center; margin-top: 20px;"> <input style="width: 100%; border: none; border-bottom: 1px solid black;" type="text"/> <input style="width: 100%; border: none; border-bottom: 1px solid black;" type="text"/> <input style="width: 100%; border: none; border-bottom: 1px solid black;" type="text"/> <input style="width: 100%; border: none; border-bottom: 1px solid black;" type="text"/> </p>
Remarks:	Track occupancy costs as per Appendix 7 point 1.2.
<small>To be completed by the keeper</small>	
Reply:	We hereby accept your quote no. <input style="width: 50px;" type="text"/> and will send you the requested wheelsets by <input style="width: 150px;" type="text"/> <small>(point 3.1 only)</small>
Addresses:	The damaged wheelsets should be returned to the address indicated below: <small>(point 3.1 only)</small> Delivery address: Station code: <input style="width: 40px; height: 20px; border: 1px solid black;" type="text"/> <div style="display: flex; justify-content: space-between; margin-top: 10px;"> <div style="width: 45%;"> <input style="width: 100%; height: 50px;" type="text"/> Billing address: <input style="width: 100%; height: 50px;" type="text"/> </div> <div style="width: 45%;"> Delivery restrictions, if applicable <input style="width: 100%; height: 100px;" type="text"/> </div> </div>
Date:	<input style="width: 150px;" type="text"/> Signature: <input style="width: 150px;" type="text"/> Company stamp: <input style="width: 150px;" type="text"/>
Please complete in block letters Form H^R Page 2	

APPENDIX 8 TO THE GENERAL CONTRACT OF USE FOR WAGONS

INTERNAL REGULATION FOR THE APPLICATION AND FURTHER DEVELOPMENT OF THE GCU

Preamble

Part I of this Appendix contains provisions regarding the GCU Bureau.

Part II describes the organisational arrangements adopted by the associations involved in the establishment of the GCU for monitoring the application of the GCU and facilitating its further development.

I. The GCU Bureau

1. The tasks of the GCU Bureau as set out in Articles 2 to 4 of the GCU shall be transferred to a trustee (the "Trustee"). The Trustee may be a physical person or a legal entity. The GCU Bureau shall be located in Brussels.

The Trustee shall take equal account of the interests of wagon keepers and RUs and assume a neutral position in potential conflicts of interest between wagon keepers and RUs.

2. The Trustee shall be proposed by the Joint Committee (see Part II below) for a term of three years at least three months before the end of the term of the Trustee in office. The appointment of the proposed Trustee shall be considered confirmed unless it is opposed by more than half the signatories within one month after the proposal has been notified to the signatories. The term of the Trustee in office may be renewed.

If the Joint Committee fails to make a proposal at the latest three months before the end of the term of the Trustee in office, other proposals may be submitted by the signatories, providing they have the written support of at least 50 signatories. Proposals made in this way shall be accepted unless opposed by more than half the signatories within three months after the proposal has been sent out to the signatories. If several such proposals are submitted by signatories, the proposal that meets with the least number of objections shall be accepted. For this voting on the proposal the procedure set out in points 8 and 9 below shall be applied accordingly, except for the shorter voting period.

3. The Joint Committee or a group of more than half of the signatories may propose an early termination of the Trustee's term, if there are significant reasons to do so. This termination shall be effective unless it is opposed by more than half the signatories within one month after the proposal has been sent out to the signatories. The procedure shall be as set out in point 2, with the Co-chairmen of the Joint Committee acting in place of the Trustee whose term is provisionally terminated.

"Significant reasons" shall mean in particular a failure on the part of the Trustee to meet its duty of neutrality or a continuous failure to perform his administrative duties in accordance with the GCU and this Appendix.

4. The Trustee shall be responsible for running the GCU Bureau. He shall maintain and further develop the designated website (the "GCU Website") for the exchange of information and the communication between the GCU Bureau and the signatories.

5. The GCU Bureau shall

- provide for translating the GCU (and its appendices) into the three languages, together with any proposed amendments;
- shall publish the GCU and any amendments thereto on the GCU Website;
- shall also publish the list of signatories on the GCU Website.

The list of signatories shall be structured as follows, based on the information provided by the signatories:

- Group 1: (Rus): Signatories that are Rus but are not also wagon keepers, with the number of tonne-kilometres they recorded in the last published business year;
 - Group 2: (Keepers): Signatories that are wagon keepers but are not also RUs, with the number of wagons which they are the keeper of and that can be used by other signatories and are registered in the GCU Wagon Data Base (see point 6. below); this group also includes wagon keepers that are legally independent majority participations of RUs, if their main business objective is the marketing (e.g. by leasing) of the wagons to third parties;
 - Group 3: (Rus and Keepers): Signatories that are both Rus and wagon keepers, with the number of wagons which they are the keeper of and that can be used by other signatories and are registered in the GCU Wagon Data Base; this group also includes wagon keepers that are not RUs themselves but are legally independent majority participations of RUs, if their main business objective is the provision of wagons for these RUs.
6. The signatories shall submit to the GCU Bureau together with the application for admission and regularly update thereafter all information required for the administration of the contract and for the communication among signatories and between signatories and the GCU Bureau, including, but not limited to contact data such as postal addresses, phone and fax numbers, e-mail addresses and contact persons. These contact data shall be published on the GCU Website in the database referenced in Appendix 1 of the contract.

The signatories shall further submit to the GCU Bureau together with the application for admission and regularly update thereafter the vehicle numbers of all wagons of which they are the keeper and that can be used by other signatories. The GCU Bureau shall make available an electronic data base (the "GCU Wagon Data Base") for this purpose on the GCU Website. The GCU Wagon Data Base shall allow to identify via the vehicle number of a wagon who is the keeper of the wagon, provided that the keeper of the wagon is a signatory of the GCU.

Each signatory via the GCU Website shall have direct access to his own data for the purpose of uploading and changing contact data or vehicle numbers. The GCU Bureau must ensure that proper right of access protection is in place and that the data are securely stored and protected against any unauthorised use.

It is the sole responsibility of each signatory to ensure the correctness of his contact data and vehicle numbers supplied to the GCU Bureau and the vehicle numbers contained in the GCU Wagon Database and to provide for any necessary updates thereafter.

7. Signatories may submit proposals for amendment to the GCU Bureau. Also the associations represented in the Joint Committee may make recommendations for amendments or additions to the GCU to the Joint Committee. These recommendations can then be adopted as proposals by unanimous consent of the Joint Committee and submitted to the GCU Bureau.

Any proposal requires either the support of at least 25 signatories or the unanimous consent of the Joint Committee. Proposals must be submitted in one of the three languages of the contract and must include the reasons for the proposed change, with an indication of the article or appendix concerned. The GCU Bureau shall check that proposals have all the required elements; incomplete proposals shall be rejected.

8. The GCU Bureau shall publish amendment proposals on the GCU Website and notify all signatories by e-mail in the three languages of the contract of the fact of the publication.
9. Signatories who do not agree with the proposed amendments must declare this by letter, fax or e-mail to the GCU Bureau within three months after the notification of the proposed amendments has been sent out by e-mail. Any signatory that has not declared disagreement by the end of this period shall be considered to be in agreement with the proposal.
10. Proposals shall be adopted if none of the signatories have opposed them within the prescribed time period or if, in each of the groups referred to in point 5, they obtain the support of at least three-quarters of the signatories in the corresponding group representing at the same time at least three-quarters of the total tonne-kilometres or wagons in the group in question.
11. Adopted amendments to the GCU shall be published on the GCU Website and the fact of the adoption shall be notified by e-mail to all signatories by the GCU Bureau within 1 week after adoption.

Amendments that are adopted unanimously shall enter into force on the date specified in the corresponding proposal; if no date is mentioned, they shall enter into force three months after adoption.

Amendments of the GCU adopted without unanimity shall enter into force the first day of the month following a period of six months after adoption.

Amendments and additions shall also be binding on signatories that did not agree with them, unless the signatories in question decide to withdraw from the contract in accordance with Article 3 of the GCU.

When proposals are not carried, the GCU Bureau shall also announce the result on the GCU Website and notify the signatories by e-mail.

12. The running costs of the GCU Bureau shall be covered by the signatories.

The GCU Bureau shall draw up an annual budget at least four months before the end of each year and have it approved by the GCU Auditors (see point 13 below). In the beginning of each calendar year the GCU Bureau shall be entitled to call in advance contributions from the signatories in order to cover the cost of the GCU Bureau for the current year in accordance with the approved budget. The GCU Auditors may approve supplementary budgets during the year if the advance contributions do not cover the actual costs or if additional funds are required for extraordinary expenses which are in the interest of the GCU and the signatories and are previously approved by the Joint Committee.

Advance contributions that have not been used up shall be taken into account in the budget for the next year.

75 per cent of the costs referred to in paragraph 1 shall be divided equally among the signatories and 25 per cent shared out on a variable basis according to the number of wagons registered in the GCU Wagon Data Base.

13. The annual accounts of the GCU Bureau shall be checked by two auditors (the "GCU Auditors") within three months after the end of each calendar year. The result of the audit shall be published on the GCU Website.

The Joint Committee shall propose the GCU Auditors for a period of up to three years parallel to the term of the Trustee. The appointment of the proposed Auditors shall be considered confirmed unless more than half the signatories opposes this proposal under the procedure set out in point 2, paragraph 1. The term of the GCU Auditors in office may be renewed.

Point 2 paragraph 2 and point 3 above shall be applied accordingly.

II. The Joint Committee

1. UIP, UIC and ERFA shall together take on the task of applying, promoting and further developing the GCU. To this end, they shall form a Joint Committee made up of representatives from the three associations. UIP and UIC shall each appoint five members to the Joint Committee and ERFA two members.
2. Two Co-Chairmen of the Joint Committee shall be chosen from among its members for a three-year term of office. One Co-Chairman shall be a representative of UIP, the other one a representative of UIC/ERFA.

The Joint Committee shall meet as and when required, though at least once a year.

3. The Joint Committee shall keep in touch with the GCU Bureau. Its decisions shall be taken unanimously. Members of the Joint Committee not being able to participate in a meeting shall give a voting proxy to another member of the Joint Committee representing the same association.

The Joint Committee shall:

- propose the Trustee to take on the tasks of the GCU Bureau and where necessary propose to terminate its term with immediate effect. The same shall apply to the Auditors;
 - make proposals for amendments and additions to the GCU;
 - review all questions of common interest in connection with the GCU and set up ad hoc working groups where necessary;
 - decide whether or not to accept the petitions of other associations representing RUs or wagon keepers to be admitted to the Joint Committee, as well as on changes of points 1 and 2 related thereto. Of such decisions the signatories shall be informed via the GCU Bureau.
4. The associations represented on the Joint Committee shall seek to ensure that when GCU signatories who are members of their associations make proposals for amendments, these are channelled first via their association to the Joint Committee, which can then discuss, finalise and decide on them and thereby encourage the achievement of a majority.

The associations shall also channel their own proposed amendments to the GCU via the Joint Committee.

APPENDIX 9
TO THE GENERAL CONTRACT OF USE (GCU) FOR
WAGONS

Technical Conditions
for Wagon Transfers
between Railway Undertakings

Applicable with effect from 1 July 2006

(Former Appendix XII to RIV 2000, applicable with effect from 1 November 2002)

-reserved-

INTRODUCTION

Former Appendix XII to the RIV, which entered force on 1 November 2002, was transposed into the GCU, brought up to date and re-published as Appendix 9 (to the GCU).

A vertical line in the margin denotes amended provisions taking effect on the date shown at the foot of the page.

This Appendix 9 enters force with the GCU (see date on title page). Appendix XII to the RIV is withdrawn on the same date.

Amendments			
Supplement		Supplement	
No.	Date	No.	Date
Supplement 1	31/01/2008		
Supplement 2	01/01/2012		
Supplement 3	01/01/2013		
Supplement 4	01/01/2014		
Supplement 5	01/01/2015		
Supplement 6	01/01/2016		
Supplement 7	01/01/2017		
Supplement 8	01/01/2018		
Supplement 9	01/01/2019		
Supplement 10	01/01/2020		
Supplement 11	01/01/2021		
Supplement 12	01/01/2022		

CONTENTS

1. GENERAL	6
2. TECHNICAL TRANSFER INSPECTION	6
2.1 DEFINITION	6
2.2 PROCEDURE	6
2.3 SKILLS OF STAFF PERFORMING TECHNICAL TRANSFER INSPECTIONS	6
3. CATALOGUE OF IRREGULARITIES (ANNEX 1)	7
3.1 PRESENTATION	7
3.2 COMMENTS ON THE CATALOGUE OF IRREGULARITIES	7
4. QUALITY MANAGEMENT SYSTEM (QMS)	8
4.1 GENERAL DEFINITIONS	8
4.2 PLANNING OF QUALITY	8
4.3 IRREGULARITIES AND CATALOGUE OF IRREGULARITIES	8
4.4 PLANNING OF TESTS	8
4.5 QUALITY CONTROL	8
4.6 INSPECTION METHODS	9
4.7 ASSESSMENT OF IRREGULARITIES	9
4.8 ANALYSIS OF RESULTS	9
4.9 CORRECTIVE MEASURES	10
5. INCLUSION OF A TRAIN IN AN AGREEMENT	10
5.1 GENERAL	10
5.2 PRINCIPLES, PLANNING, EXECUTION	11
5.3 EXCLUSION OF TRAINS FROM AN AGREEMENT	12
Annex 1	Catalogue of irregularities including classification into classes for use in the Quality Management System
Annex 2	Irregularity classes
Annex 3	Size of samples as per ISO 2859 – Part 1 Excerpt from Table 2-A with acceptance values for irregularity classes 4 and 5 Overview I: Procedure for the inclusion of a train in an agreement Overview II: Procedure for the exclusion of trains from an agreement Record of the inclusion of trains in an agreement
Annex 4	Verification of qR
Annex 5	Catalogue of inspections in accordance with Annex 1
Annex 6	Technical transfer inspection – List of irregularities noted on wagons and their loads

- Annex 7 Technical transfer inspection – Record and analysis of irregularities noted on wagon and loads
- Annex 8 Handling of wagons
- Annex 9 Checklists
- Annex 10 Positions of the brake stopcock handle for compressed air brakes
- Annex 11 I, K, M, R1 and U labels
- Annex 12 Traceability

1. GENERAL

1.1 **Annex 1** of this appendix sets out binding provisions governing the technical condition of wagons exchanged between two or more railway undertakings (RUs), as established during a technical transfer inspection.

1.2 It describes (in point 4 and Annexes 5, 6 and 7) a quality assurance procedure to be applied by RUs that have signed agreements governing the technical conditions for the exchange of freight wagons.

2. TECHNICAL TRANSFER INSPECTION

2.1 DEFINITION

2.1.1 Transfer inspection

The term “technical transfer inspection” shall refer to:

- a technical inspection upon handover conducted by the transferor RU,
- a technical inspection upon acceptance conducted by the transferee RU,
- a technical inspection conducted at a different location from the handover point (conducted by the transferor RU).

2.1.2 Date/time of handover and acceptance

The date/time of the handover/acceptance marks the transfer of custody of the vehicles in the sense of article 22.1. The location and date/time shall be agreed on. In the absence of an agreement, acceptance counts as the moment of transfer of custody.

2.2 PROCEDURE

The technical transfer inspection shall be carried out by qualified staff at a place agreed upon by the RUs involved.

The inspection shall involve assessing the operating safety and railworthiness of wagons, identifying any of the irregularities listed in **Annex 1** (Catalogue of irregularities) and taking appropriate steps. To identify any irregularities, the qualified staff shall walk the full length of the train on both sides and carefully examine each wagon.

2.3 SKILLS OF STAFF PERFORMING TECHNICAL TRANSFER INSPECTIONS

All safety-related examinations from Appendix 9, **Annex 1** must be performed by properly qualified technical staff.

This staff must have the following minimum qualifications:

- General knowledge of rail vehicle maintenance,
- General knowledge of rail vehicle design and operation,
- General knowledge of brake design and operation,
- Ability to appraise technical damage and irregularities occurring on wagons and loads and their impact on operations,

- Knowledge of the UIC Loading Guidelines,
- Knowledge of regulatory documents concerning the exchange of vehicles between railway undertakings (RUs) and the related agreements in force.

The staff must receive training in order to acquire the above-mentioned skills and must update said skills regularly.

The required skills include theoretical and practical knowledge.

3. CATALOGUE OF IRREGULARITIES (ANNEX 1)

3.1 PRESENTATION

Annex 1 contains five columns:

- (1) List of wagon components and aspects of the load to be examined,
- (2) Code number,
- (3) Irregularities, where appropriate with criteria and indications to facilitate detection. Possible means of recognising irregularities are marked “•” without this being a requirement to execute the measures,
- (4) Action to be taken,
- (5) Irregularity class.

3.2 COMMENTS ON THE CATALOGUE OF IRREGULARITIES

3.2.1 All the dimensions (values) quoted should be measured in cases of doubt.

3.2.2 The provisions of the Loading Guidelines (published separately) remain fully applicable.

In this connection, qualified staff shall particularly look out for the irregularities listed under section 7 of the catalogue (**Annex 1**), column (3) of which contains cross-references in brackets to the relevant points of Volume 1 of the Loading Guidelines. Qualified staff shall also watch out for other visible signs that the load or load securing equipment is compromising operating safety and shall take appropriate action.

3.2.3 To help locate irregularities and defects, qualified staff shall use stick-on labels (see specimens in **Annex 11**) and shall, in written correspondence, quote the code number specified in column (2) of **Annex 1**.

3.2.4 This appendix is not an exhaustive catalogue of all the irregularities which might occur. Where there are other irregularities not listed in this document, but which might well compromise operating safety or the wagon's railworthiness, qualified staff shall take whatever action they deem necessary. Such irregularities are to be documented by means of the superordinate code applicable in context to the part/components/aspect in question and are to be assigned to at least the second grouping level.

3.2.5 The expression “Detach wagon” means that the wagon may not continue its onward conveyance if it presents an irregularity that could impact on the safety of operations.

3.2.6 Once detached, the wagon remains in the custody of the user RU which recorded the irregularity whilst the irregularity is being rectified.

4. QUALITY MANAGEMENT SYSTEM (QMS)

4.1 GENERAL DEFINITIONS

Use of a quality management system (QMS) provides a guarantee of quality for wagon exchanges between RUs. The aim is to determine a set standard of technical quality by means of representative spot checks in accordance with ISO standard 2859. This technical quality must be formally set out in writing and the RUs must take all necessary action to maintain or improve it.

4.2 PLANNING OF QUALITY

Quality requirements and characteristics are defined during the planning phase and are set out in detail in the catalogue of inspections. The quality target agreed between RUs is to obtain a cumulative defect value (CDV) of $\leq 1\%$ for each class of irregularity.

4.3 IRREGULARITIES AND CATALOGUE OF IRREGULARITIES

4.3.1 An irregularity is defined as any deviation from the quality criteria defined in the catalogue if as a consequence of this deviation the equipment or train in question does not conform to the set requirements. Equipment on which irregularities have been noted must be dealt with in accordance with the catalogue of irregularities in Appendix 9 to the GCU (**Annex 1**).

4.3.2 Description of irregularities

Irregularities are classified as minor, major or critical, according to their seriousness, and are defined in **Annex 2**.

4.3.3 In addition to listing the various kinds of damage / irregularity and the corresponding action to be taken, the catalogue of irregularities (**Annex 1**) also indicates the category to which each irregularity belongs.

4.3.4 Irregularities not listed in this document, but which might well compromise operating safety or the wagon's railworthiness must be assigned to irregularity class 3 at least.

4.4 PLANNING OF TESTS

The number of wagons to be inspected, referred to as the "inspection batch", shall be determined from the "overall batch", which includes all wagons handed over by one RU to other RUs (including via one or more transit RUs) in a given calendar year. The overall batch may be divided into partial batches, for example according to specific routes or handover points. From this overall batch (or corresponding partial batches) is determined an "inspection batch", as specified in ISO standard 2859 (**Annex 3**) which is then incorporated into the annual inspection schedule as a theoretical inspection batch. When dividing up into partial inspection batches defined on a monthly basis, account should be taken where possible of annual trends in the changing number of wagons.

When determining the inspection batch, inspection level II should be applied.

4.5 QUALITY CONTROL

The conformity of the technical transfer inspections shall be measured by the transferee RU during the spot-checks. These checks shall be carried out at the latest at the first marshalling yard at which technical inspections are conducted or at the station where the

train consist is disconnected or re-formed by the transferee RU. Quality checks shall be carried out before the train is disconnected or re-formed, in accordance with the procedure of qualified staff described in point 2.2.

4.6 INSPECTION METHODS

The inspection methods referred to in the catalogue (**Annex 5**) have the following meanings:

- VC = visual check inspection with naked eye
- M = measurement inspection based on measurement
- HT = hammer test inspection involving hammer blows
- OP = operate operating test
- PM = pull or move actuation of the part in question

4.7 ASSESSMENT OF IRREGULARITIES

Defects and irregularities already dealt with by the RU that carried out the transfer inspection by applying the measures indicated in the catalogue of irregularities (**Annex 1**) are not to be considered as irregularities. If a wagon has been labelled by the RU that carried out the technical transfer inspection, only the irregularities that are not mentioned on the label may be taken into account for calculating the CDV value. Identical irregularities that occur on several sub-components (such as stanchions) are considered in principle as one irregularity per wagon or per load unit. The same applies to load residues and/or load securing equipment that has not been removed. Where irregularities on a given component or load have been given different classifications, only the irregularity in the higher class should be recorded.

4.8 ANALYSIS OF RESULTS

4.8.1 It is the type of irregularity rather than its frequency of occurrence which is the decisive factor in evaluating the number of irregularities within the context of the quality management system. Each type of irregularity has a serial number in the Catalogue of Irregularities (**Annex 1**).

4.8.2 Cumulative defect value (CDV)

The CDV value, which is used as a means of measuring the defective nature of the inspection batches, is calculated as a percentage of irregularities per hundred control units. To this end, the irregularities are assigned to a class, depending on their impact on fitness for use in service and on operating safety, as follows:

- Class 3 factor of 0.125/1
- Class 4 factor of 0.4/1
- Class 5 factor of 1/1

The CDV value for each class of irregularity is then calculated using the following formula:

$$\text{CDV Class 3 [\%]} = \frac{0.125 \times \Sigma \text{ Class 3 irregularities} \times 100}{\text{Number of units checked}}$$

$$\text{CDV Class 4 [\%]} = \frac{0.4 \times \Sigma \text{ Class 4 irregularities} \times 100}{\text{Number of units checked}}$$

$$\text{CDV Class 5 [\%]} = \frac{1.0 \times \Sigma \text{ Class 5 irregularities} \times 100}{\text{Number of units checked}}$$

4.8.3 The irregularities recorded shall be sent each month to the RU that carried out the technical transfer inspection using the lists given in **Annexes 6** and **7**, indicating the type of overall batch and the quantity of units inspected for each CDV. The information described in **Annexes 6** and **7** can be exchanged in a variety of ways and by electronic means in particular.

4.9 CORRECTIVE MEASURES

If the quality target specified in point 4.2 above is not achieved, the RU that carried out the technical transfer inspection, must take corrective measures to improve the standard of quality. The transferee RU shall immediately inform the transit RU(s), where appropriate. The RU that carried out the technical transfer inspection shall notify the transferee RU and where appropriate the transit RU(s) of the action taken within one month.

With effect from the implementation of these measures, a representative sample must be selected each month, in order to show the resulting improvements.

If necessary, the transferee RU may, in agreement with the transit RU(s) as appropriate, exclude certain wagons (or wagons with a particular load) when forming the trains in question.

5. INCLUSION OF A TRAIN IN AN AGREEMENT

5.1 GENERAL

This procedure is recommended to RUs that are planning to conclude agreements.

The procedure does not apply if all the trains exchanged between two RUs are covered by the agreement.

In order to include trains in an agreement, independently of a cumulative defect value, RUs shall apply a procedure based on DIN/ISO 2859 (Sampling procedures for inspection by attributes – Sampling schemes indexed by **Acceptance Quality Limit (AQL)**).

However, trains may only be included in an agreement if acceptability is achieved over a defined period of time for a specific batch (in this case a train).

Table 2-A (Simple sampling guidelines for standard inspections, see **Annex 3**) offers clear criteria for determining the acceptability of inspection batches (in this instance, trains). Once the acceptability of the train has been established, the RU inspecting the handover and quality shall send the participating RUs an inspection report in accordance with **Annex 3** for signature.

The participating RUs are to be informed of any irregularities noted during the control period.

Following their inclusion in the agreement, these trains must nonetheless meet the agreed quality target of a CDV $\leq 1\%$ for each class of irregularity.

The procedures for the carriage of dangerous goods (RID) shall be dealt with separately.

5.2 PRINCIPLES, PLANNING, EXECUTION

In this procedure, the following principles apply:

- Irregularity classes 5 and 4 shall be considered separately (class 3 shall not be considered initially);
- An AQL defined in accordance with DIN/ISO 2859 as the “Number of defects per 100 control units” shall be applied;

For a K defect (Class 5) which is evaluated on a 1:1 basis, an AQL of 1.0 is equivalent to one defect per 100 control units and for an H defect (Class 4) which is evaluated on a 0.4:1 basis, an AQL of 2.5 is equivalent to one defect per 100 control units.

- The inspection/control period for a given train should be at least three months;
- Each month at the interface between RUs, the quality of the transfer shall be determined by spot-checks with the required sample size and the results documented in a test protocol;
- The inclusion of a given train shall only be accepted if, over the inspection period/control period, the acceptance value specified in Table 2-A DIN/ISO 2859 (**Annex 3**) for classes 5 and 4 is not exceeded.

This procedure is shown in Overview I, **Annex 3**.

5.2.1 Example

Train	12345
Days of operation	7
Average number of wagons	32
Wagons per year	11648
Wagons over the inspection period (3 months)	2912
Batch size as per Annex 3 , Table 1, Inspection level II	1201 – 3000
Code letter calculated	K
Sample size as per Annex 3 , Table 2-A	125
Inspections per month	42
Acceptance value for class 5 (AQL 1.0) as per Annex 3 , Table 2-A	3
Acceptance value for class 4 (AQL 2.5) as per Annex 3 , Table 2-A	7

5.2.2 Results of the inspection

a) After 125 inspections, the following was observed:

1 defect in class 5, 9 defects in class 4.

Train 12345 cannot be included in an agreement since the acceptance value for class 4 was exceeded during the inspection period.

The inspection period is extended by at least one more month.

b) After 125 inspections, the following was observed:

4 defects in class 5, 3 defects in class 4.

Train 12345 cannot be included in an agreement since the acceptance value for class 5 was exceeded during the inspection period.

The inspection period is extended by at least one more month.

If the acceptance values for classes 5 or 4 are exceeded by a substantial amount, a new 3-month inspection period is recommended.

5.3 EXCLUSION OF TRAINS FROM AN AGREEMENT

The procedure is set out in overview II, **Annex 3**.

APPENDIX 9, ANNEX 1

Catalogue of irregularities including classification into classes for use in the Quality Management System

CONTENTS

- 1 Running gear**
- 2 Suspension**
- 3 Brake**
- 4 Wagon underframe and bogie frame**
- 5 Buffing and draw gear**
- 6 Wagon body**
 - 6.1 Wagon body in general
 - 6.2 Covered wagons
 - 6.3 Open wagons
 - 6.4 Flat wagons
 - 6.5 Tank wagons
 - 6.6 Wagons with special fittings
 - 6.7 Gear for securing load units (ILU) on carrier wagons
- 7 Loads and intermodal loading units (ILU)**
 - 7.1 Load in general
 - 7.2 Load securing equipment
 - 7.3 Loading and load securing methods
 - 7.4 Special types of consignment
 - 7.5 Specific components ILU
 - 7.6 ILU tank
 - 7.7 Loading of ILU
 - 7.8 Marking, coding
- 8 Particular incidents**
 - 8.1 Operating irregularities
 - 8.2 Other events

-reserved-

Component	Code no.	Irregularities/Criteria/Notes	Action to be taken	Irregularity class
Running gear	1			
Tyred wheel	1.1	Thickness less than:		
	1.1.1	<ul style="list-style-type: none"> – 35 mm on wagons suitable for running at 120 km/h (SS wagons or wagons marked “***) – 30 mm on other wagons¹ 	Detach wagon	4
	1.1.2	Tyre <ul style="list-style-type: none"> – broken – cracked lengthways or crossways 	Detach wagon	5
	1.1.3	Tyre loose <ul style="list-style-type: none"> – inspection marks inconsistent or unclear ring or – tyre clip loose or – appearance of rust between the tyre and the rim over more than one third of the circumference 	Detach wagon	5
	1.1.4	Inspection marks <ul style="list-style-type: none"> – missing – not clearly discernible 	Detach wagon	4
	1.1.5	Tyre shifted sideways <ul style="list-style-type: none"> – tyre clip loose or visibly distorted 	Detach wagon	5
	1.1.6	Damage to tyre clip <ul style="list-style-type: none"> – cracked – broken – missing 	Detach wagon	5

¹ Including wagons that can only be operated at 120 km/h when empty

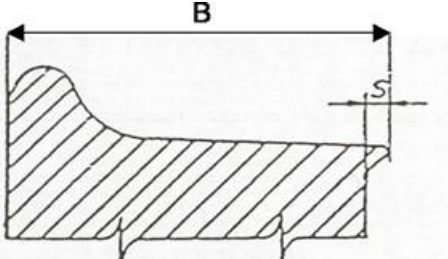
Component	Code no.	Irregularities/Criteria/Notes	Action to be taken	Irregularity class
Solid wheel	1.2 1.2.1	Groove marking the minimum thickness is no longer fully visible in cross-section ²	Detach wagon	4
	1.2.2	Thermal overload due to braking <ul style="list-style-type: none"> • obviously recent paint burns of 50 mm or more at connection between rim and wheel plate (cracks or shelling on paint) • traces of rust on rim (plate not painted) • fusion of brake blocks • deterioration of wheel tread with build-up of metal (see also no. 1.3.4) • Uneven blueish appearance on rim due to the effect of thermal overload 	Proceed in accordance with Annex 8, point 4	
	1.2.2.1	– without gauge widening of the inner faces	K + R1 (isolate brake)	4
	1.2.2.2	– with gauge widening of the inner faces	Detach wagon	5
	Tyre or corresponding part of solid wheel	1.3 1.3.1 1.3.1.1	Width Width B > 139 mm and ≤ 140 mm	M
1.3.1.2		Width B > 140 mm < 133 mm <ul style="list-style-type: none"> • presence of a projection (“S”) 	Detach wagon	4
1.3.2		Tread crushed in places, uneven contact surfaces or irregular protrusions on the wheel rim.	Detach wagon	4

² The outer groove indicates the minimum thickness (wear groove) should a wheel – as an exception – have two grooves.

Component	Code no.	Irregularities/Criteria/Notes	Action to be taken	Irregularity class
Tyre or corresponding part of solid wheel (continued)	1.3.3	Wheel flat		
	1.3.3.1	– wheel $\varnothing > 840$ mm, wheel flat > 60 mm long	Detach wagon	4
	1.3.3.2	– wheel \varnothing : $630 \text{ mm} < d \leq 840$ mm, wheel flat > 40 mm long	Detach wagon	4
	1.3.3.3	– wheel $\varnothing \leq 630$ mm, wheel flat > 35 mm long	Detach wagon	4
	1.3.4	Build-up of metal		
	1.3.4.1	– wheel $\varnothing > 840$ mm, metal build-up over a length of > 60 mm or ≥ 1 mm thick	Detach wagon	4
	1.3.4.2	– wheel $\varnothing > 840$ mm and metal build-up over a length of > 10 mm ≤ 60 mm and < 1 mm thick	M + R1 (isolate brake)	3
	1.3.4.3	– wheel \varnothing : $630 \text{ mm} < d \leq 840$ mm and metal build-up over a length of > 40 mm or ≥ 1 mm thick	Detach wagon	4
	1.3.4.4	– wheel \varnothing : $630 \text{ mm} < d \leq 840$ mm and metal build-up over a length of > 10 mm ≤ 40 mm and < 1 mm thick	M + R1 (isolate brake)	3
	1.3.4.5	– wheel $\varnothing \leq 630$ mm and metal build-up over a length of > 35 mm or ≥ 1 mm thick	Detach wagon	4
	1.3.4.6	– wheel $\varnothing \leq 630$ mm and metal build-up over a length of > 10 mm ≤ 35 mm and < 1 mm thick	M + R1 (isolate brake)	3
	1.3.5	Cavity, shelling or flaking		
	1.3.5.1	– wheel $\varnothing > 840$ mm, length > 60 mm	Detach wagon	4
	1.3.5.2	– wheel \varnothing : $630 \text{ mm} < d \leq 840$ mm, length > 40 mm	Detach wagon	4
	1.3.5.3	– wheel $\varnothing \leq 630$ mm, length > 35 mm	Detach wagon	4
	1.3.6	Cracks and notches		
1.3.6.1	Cracks at the interface between the wheel tread and the front edge	Detach wagon	5	

Component	Code no.	Irregularities/Criteria/Notes	Action to be taken	Irregularity class
Tyre or corresponding part of solid wheel <i>(continued)</i>	1.3.6.2	Sharp-angled notches on the front face (rim or inner tyre rim) caused by tools, track brakes or clamping equipment/ jaws – except for markings applied by the manufacturer	K	4
	1.3.6.3	Cracks on the tread - isolated cracks • Without characteristics of thermal overload	K + R1 (isolate brake)	4
	1.3.6.4	• With characteristics of thermal overload	Detach wagon	5
	1.3.7	Deposits of paint, oil or lubricants on wheel tread edge, except for – control marks (4 paint marks positions 90° apart) – friction modifiers	Detach wagon	5
	1.3.8	Formation of grooves, hollows/furrows, false flanges (hollows) ³ on the wheel tread		
	1.3.8.1	Grooves with sharp edges < 1 mm deep	K + R1 (isolate brake)	4
	1.3.8.2	Grooves with sharp edges ≥ 1 mm deep	Detach wagon	5
	1.3.8.3	Furrows and false flanges > 2 mm deep	Detach wagon	5

³ **Grooves** appear on the entire circumference of the wheel and may affect the whole width of the wheel tread; they are characterised by transitions to sharp edges. **Hollows/furrows** appear on the entire circumference of the wheel and may affect the whole width of the wheel tread; they are characterised by a rounded contour, with no transition to sharp edges. **False flange**: there is a false flange when the outer part of the wheel tread is higher than the wheel tread at the level of the tread section

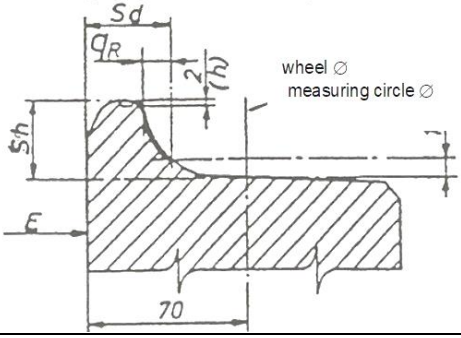
Component	Code no.	Irregularities/Criteria/Notes	Action to be taken	Irregularity class
Flange	1.4 1.4.1	Height of flange S_h greater than 36 mm <ul style="list-style-type: none"> hollow on wheel tread Wagon with LL brake blocks and permissible speed greater than 100 km/h Height of wheel flange S_h greater than 32 mm <ul style="list-style-type: none"> Hollow on wheel tread 	Detach wagon	4
	1.4.2	Flange thickness S_d – wheel $\varnothing > 840$ mm $S_d < 22$ mm – wheel $\varnothing: 760 \text{ mm} \leq d \leq 840$ mm $S_d < 25$ mm – wheel $\varnothing < 760$ mm $S_d < 27.5$ mm Wagons with LL or K brake blocks – wheel $\varnothing > 330$ mm $S_d > 33$ mm <ul style="list-style-type: none"> worn flange 	Detach wagon	5
	1.4.3	Wear of guide faces – $qR \leq 6.5$ mm (see Annex 4) <ul style="list-style-type: none"> sharp flange 	Detach wagon	5
	1.4.4	Burrs or sharp edges on guide face at a distance $h > 2$ mm from maximum height of flange (see also Annex 4) 	Detach wagon	5
Wheel centre	1.5 1.5.1	Solid wheel Damage to wheel centre or wheel hub – cracked – defect repaired by welding	Detach wagon	5

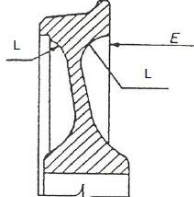
Component	Code no.	Irregularities/Criteria/Notes	Action to be taken	Irregularity class
Wheel centre <i>(continued)</i>	1.5.2	Tyred wheel Damage to wheel centre, tyre clip, tyre – cracked – broken – defect repaired by welding	Detach wagon	5
Axle	1.6 1.6.1	Damage to axle – cracked – deformed (see also no. 1.7.1) – defect repaired by welding – sharp edge – worn to a depth of more than 1 mm	Detach wagon	5
	1.6.2	Worn to a depth of ≤ 1 mm, no sharp edges	K + R1 (isolate brake)	4
	1.6.3	Part rubbing against axle Also check nos. 1.6.1 and 1.6.2	Tie up + K, if necessary R1 (isolate brake). If not possible, detach wagon	4
Wheelset	1.7 1.7.1	Clearance E between internal faces non-compliant with the following limit values: – $\varnothing > 840$ mm $1357 \text{ mm} \leq E \leq 1363 \text{ mm}$ – $\varnothing \leq 840$ mm $1359 \text{ mm} \leq E \leq 1363 \text{ mm}$ If in all cases, $E_{\text{max}} - E_{\text{min}} > 2 \text{ mm}$ • signs of derailment • signs of movement of wheel on axle • heating (solid wheel) in “L” fillet zone between web and rim/tyre 	Detach wagon	5

Component	Code no.	Irregularities/Criteria/Notes	Action to be taken	Irregularity class
<p>Signs of out-of-round wheels</p>	<p>1.7.2</p>	<p>Brake triangle pin sheared off</p> <p>Brake safety stirrup broken (see also no. 3.1.2)</p> <p>Shiny traces on the brake triangle end washer</p> <p>Shiny traces on the inner spring (load spring) (see also no. 2.5)</p> <p>Lifting safety catch (“T”) missing or loose (see also no. 2.5.5)</p> <p>Y25 bogies: hard manganese wear plates on axle boxes or axle-box guides have fallen off or welded joints loose (see also no. 1.8.4 and 4.4.2)</p> <p>Tread crushed in places, uneven contact surfaces or irregular protrusions on the wheel rim (see also no. 1.3.2)</p>	<p>If at least two of these signs are noted on or near a wheel:</p> <p>K + add comment “Suspected out-of-round wheel”</p>	<p>4</p>

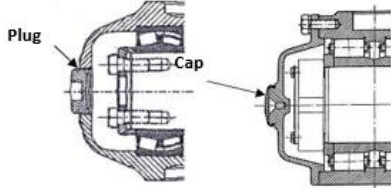
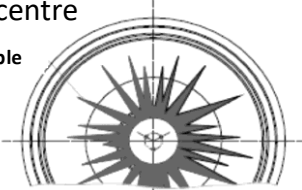
Component	Code no.	Irregularities/Criteria/Notes	Action to be taken	Irregularity class
Axle box	1.8			
	1.8.1	Housing		
	1.8.1.1	Housing not watertight Defect allowing water or dust to enter <ul style="list-style-type: none"> – cracked or broken housing – missing plug (NB: the loss of the protective cover of the centring cone is permissible) – except housing types without cover 	Detach wagon	4
	1.8.1.2	Loss of lubricant <ul style="list-style-type: none"> • grease or oil discharge on the wheel centre not permissible 	Detach wagon	4
	1.8.1.3	<ul style="list-style-type: none"> • trace of grease or oil in the area of the housing cover 	K	4
	1.8.2	Axle box guides no longer able to guide the axle <ul style="list-style-type: none"> • guide broken • axle box in abnormal position 	Detach wagon	5
	1.8.3	Hot box		
1.8.3.1	– housing too hot to touch with back of hand <ul style="list-style-type: none"> • traces of rust 	Detach wagon	5	
1.8.3.2 ⁴	Confirmation by the RU of box over-heating during transport	Detach wagon	5	
Hard manganese wear plate on axle box of Y bogie or derivative designs	1.8.4	Displaced or missing	Detach wagon	4

⁴ Hot box: Observation by automatic detection – Observation outside the scope of TI by special inspection.

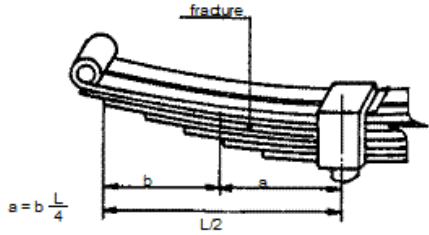
Component	Code no.	Irregularities/Criteria/Notes	Action to be taken	Irregularity class
Suspension	2			
Leaf spring	2.1			
	2.1.1	Leaves displaced by more than 10 mm with respect to buckle <ul style="list-style-type: none"> shiny marks near buckle 	Detach wagon	4
	2.1.2	Main leaf fractured or with visible crack	Detach wagon	5
	2.1.3	Part of a fractured spring missing	Detach wagon	4
	2.1.4	Fracture (but without any part missing) of intermediate leaf at a distance from the centre of the spring of:		
	2.1.4.1	of: <ul style="list-style-type: none"> < $\frac{1}{4}$ of leaf length 	Detach wagon	4
	2.1.4.2	– > $\frac{1}{4}$ of leaf length	M	3
				
2.1.5	Insufficient spring clearance: <p>Vertical distance between buckle and fixed parts of body, underframe or bogie frame less than 15 mm</p> <ul style="list-style-type: none"> signs of recent contact between buckle and fixed parts of the underframe or bogie frame signs of recent contact between wheel and underframe or wagon floor/body 	Detach wagon	5	
2.1.6	Buckle loose <ul style="list-style-type: none"> fracture of crack in buckle key missing or ineffective signs of loosening of leaves 	Detach wagon	5	

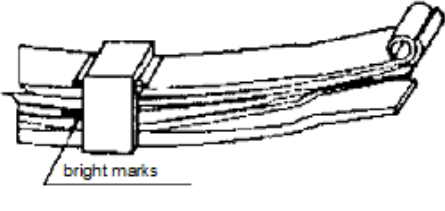
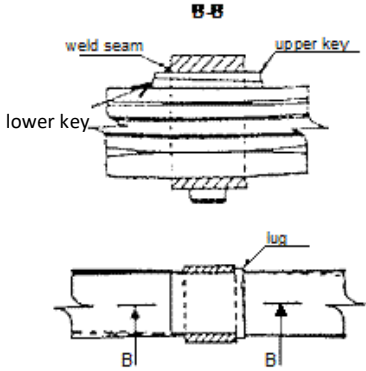
Component	Code no.	Irregularities/Criteria/Notes	Action to be taken	Irregularity class
Additional criteria for parabolic spring	2.2			
	2.2.1	Main or intermediate spring leaf		
	2.2.1.1	visible crack or break	Detach wagon	5
	2.2.1.2	Buckle broken <ul style="list-style-type: none"> • two leaves touching over 50 % of their length 	Detach wagon	5
	2.2.2	Leaf displaced lengthways		
	2.2.2.1	– by more than 10 mm	Detach wagon	4
	2.2.2.2	– by 10 mm or less <ul style="list-style-type: none"> • shiny marks near buckle 	K	3
2.2.3	Buckle damaged or loose <ul style="list-style-type: none"> – buckle fractured, cracked – lug of the lower key cracked – weld seam of upper key fractured or cracked 	Detach wagon	5	

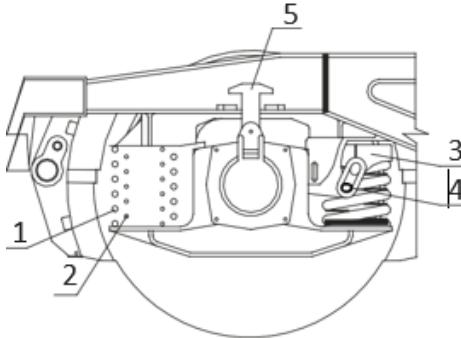
Component	Code no.	Irregularities/Criteria/Notes	Action to be taken	Irregularity class
Helical spring	2.3			
	2.3.1	Broken	Detach wagon	5
Connection between suspension and axle box or between suspension and bogie frame	2.4			
	2.4.1	Boss of buckle out of position <ul style="list-style-type: none"> • abnormal position of axle box 	Detach wagon	5
	2.4.2	Shackle, links displaced, missing, broken, unhooked	Detach wagon	5
	2.4.3	Link pin displaced, missing, not secured	Rectify. If not possible, detach wagon	5
	2.4.4	Suspension links worn or too long <ul style="list-style-type: none"> • recent traces of contact on the solebar 	K	4
Suspension system of Y 25 bogies or derived systems	2.5	 <p>1. Tare spring 4. Damper ring 2. Load spring 5. Lifting T 3. Spring cap</p>		
	2.5.1	Main/tare spring cracked or broken	Detach wagon	5
	2.5.2	Auxiliary/load spring displaced or broken		
	2.5.2.1	– on empty wagon	K	3
	2.5.2.2	– on loaded wagon <ul style="list-style-type: none"> • axle box no longer horizontal 	Detach wagon	5
	2.5.3	Damper ring(s) missing or broken <ul style="list-style-type: none"> • contact marks 		
	2.5.3.1	– one ring per bogie	K	3
	2.5.3.2	– more than one ring per bogie	Detach wagon	5

Component	Code no.	Irregularities/Criteria/Notes	Action to be taken	Irregularity class
Suspension system of Y 25 bogies or derived systems <i>(continued)</i>	2.5.4	Spring cap(s) in contact with bogie frame		
	2.5.4.1	– one spring cap in contact with bogie	K	3
	2.5.4.2	– more than one spring cap in contact per bogie	Detach wagon	5
	2.5.5	Lifting T (safety catch) loose or missing	M	3
	2.5.6	Insufficient spring clearance: Vertical distance between axle-box housing and bogie frame less than 8 mm <ul style="list-style-type: none"> • Recent signs of contact between axle-box housing and bogie frame 	Detach wagon	5

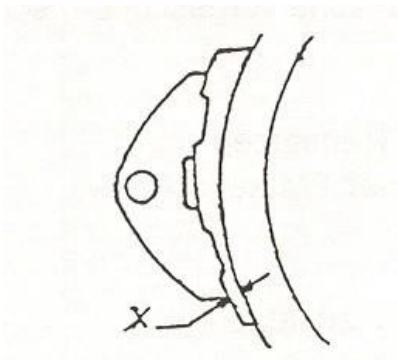
Component	Code no.	Irregularities/Criteria/Notes	Action to be taken	Irregularity class
Brake	3			
Mechanical part (rigging)	3.1			
	3.1.1	Parts of brake rigging hanging down or broken Check also 1.6.1, 1.6.2, 1.6.3	Temporary repair, K + R1 (isolate brake)	4
	3.1.2	Safety strap ineffective	Temporary repair, K	4
	3.1.3	Brake isolating cock (see also Annex 10)		
	3.1.3.1	– unusable	Detach wagon	3
	3.1.3.2	– position unclear	K + R1 (isolate brake), detach wagon if necessary	3
	3.1.4	Empty/loaded or G/P changeover system unusable	K + R1 (isolate brake)	3
3.1.5	Brake release pull broken or missing	K + R1 (isolate brake)	3	
Brake block	3.2			
	3.2.1	Cast-iron brake block – missing – broken, cracked right through, even if still held together by its metal insert – worn so that thickness X near brake block is less than 10 mm 	Replace. If not possible, K + R1 (isolate brake)	3

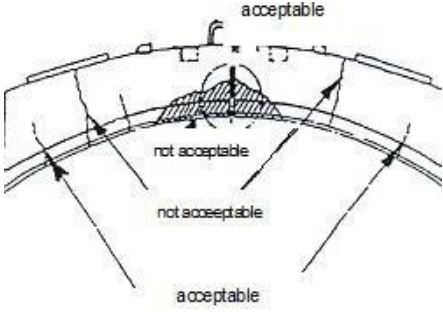
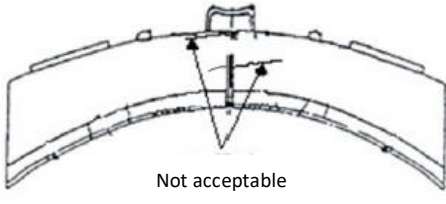
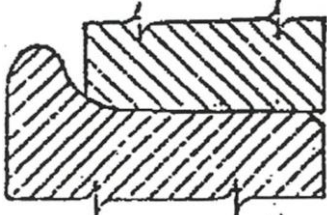
Component	Code no.	Irregularities/Criteria/Notes	Action to be taken	Irregularity class
<p>Brake block <i>(continued)</i></p>	<p>3.2.2</p>	<p>Composite brake block</p> <ul style="list-style-type: none"> - missing - radial crack from friction surface through to plate edge (except at the designated expansion joint) <p>Friction material:</p> <ul style="list-style-type: none"> - visible crumbling of the friction material over more than one quarter of the block length, or metal inclusions - detached from back plate by more than 25 mm  <ul style="list-style-type: none"> - cracked over more than 25 mm in direction of wheel circumference - lowest thickness X less than 10 mm 	<p>Replace. If not possible, K + R1 (isolate brake)</p>	<p>3</p>
	<p>3.2.3</p>	<p>Brake block protruding</p> <ul style="list-style-type: none"> • a brake block is considered to be protruding once its outer surface reaches the outer edge of the wheel rim 	<p>K + R1 (isolate brake)</p>	<p>4</p>

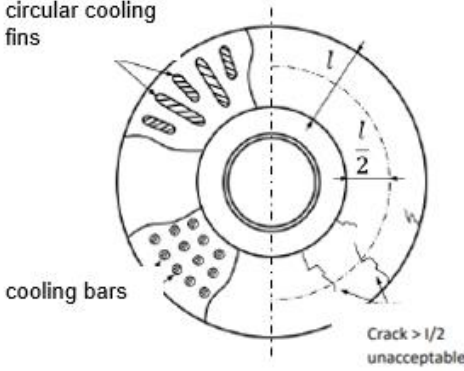
Component	Code no.	Irregularities/Criteria/Notes	Action to be taken	Irregularity class
Disc brakes* * Observed during a special inspection separate to the technical inspection	3.2.4			
	3.2.4.1	The inspection groove on the brake discs is no longer completely visible (maximum wear)	K + R1 (isolate brake)	3
	3.2.4.2	Defective brake disc fixing on the axle pin	Detach wagon	5
	3.2.4.3	Brake disc: unacceptable cracks > l/2 as per diagram 	K + R1 (isolate brake)	3
	3.2.4.4	Crack in cross-section	Detach wagon	5
	3.2.4.5	Missing or cracked cooling bars – more than 2 side by side – more than 6 in total	K + R1 (isolate brake)	3
	3.2.4.6	Cracked circular cooling fins – more than 4, with less than 3 cooling lines intact between the cracked fins	K + R1 (isolate brake)	3
	3.2.5	Brake linings – missing – cracked	K + R1 (isolate brake)	3
Brake indicator	3.2.6	Defective or brake indicator data not true to the status of the brake or display not synchronous with the indicator (other than indications relating to the handbrake)	K + R1 (isolate brake)	4

Component	Code no.	Irregularities/Criteria/Notes	Action to be taken	Irregularity class
Pneumatic part	3.3			
	3.3.1	Main brake pipe		
	3.3.1.1	Main brake pipe inoperative	Detach wagon	4
	3.3.1.2	- reserved -		
	3.3.2	Brake coupling		
	3.3.2.1	Damaged or missing (brake couplers must be available at all existing coupler connections on either end of a wagon)	Replace	3
	3.3.2.2	Unused brake coupler hanging loose (where two couplers are available, only one may be plugged in)	Secure, rectify as appropriate	3
	3.3.2.3	- reserved -		
	3.3.3	Brake coupler hold not fit for use	M	3
	3.3.4	Air brakes unfit for use but not labelled as such	Check and, if damaged, K + R1 (isolate brake)	3
	3.3.5	Stopcock		
	3.3.5.1	Unusable, leaking, warped or handle missing	Detach wagon	5
	3.3.5.2	Stopping device missing or visibly damaged	Rectify + K. If not possible, detach wagon	4
	3.3.6	DET (derailment detector)		
	3.3.6.1	Derailment detector tripped	Rectify + M, proceed according to point 5 of Annex 8	3
3.3.6.2	Detector not airtight	Isolate detector + M, proceed according to point 5 of Annex 8	3	
3.3.6.3	Detector's connection hose not airtight	Rectify + M, if not possible, remove	4	

Component	Code no.	Irregularities/Criteria/Notes	Action to be taken	Irregularity class
Spark arrestor plate	3.4			
	3.4.1	Plate missing or rusted through	K + R1 (isolate brake)	4
	3.4.2	Plate hanging loose	Remove plate, K + R1 (isolate brake), if not possible, detach wagon	4
	3.4.3	<p>Consignments of dangerous goods for which spark arrestor plates are stipulated in the RID</p> <p>Non-bogie wagon</p> <p>– non-standard spark arrestor plate</p> <ul style="list-style-type: none"> • non-bogie wagon not bearing the following marking 	R1 (isolate brake)	5
Hand brake	3.5			
	3.5.1	Clearly unfit for use	K + R1	3

Component	Code no.	Irregularities/Criteria/Notes	Action to be taken	Irregularity class
Wagon underframe and bogie frame	4			
Wagon underframe	4.1 4.1.1	Underframe warped vertically or horizontally <ul style="list-style-type: none"> • buffer height out of tolerance range (see no. 5.1.2) • visible distortion 	Detach wagon	5
	4.1.2	Solebar, headstock stressed by coupler or intermediate crossbar exhibiting a fracture or crack <ul style="list-style-type: none"> – fracture – lateral crack starting from edge of flange and extending over more than half the width of flange – longitudinal crack > 100 mm near suspension brackets – longitudinal crack > 150 mm for other parts – cracking at visible welds of these component parts 	Detach wagon	4
Axle guard	4.2 4.2.1	Distorted, safety hazard	Detach wagon	5
	4.2.2	Broken <ul style="list-style-type: none"> • abnormal position 	Detach wagon	5
	4.2.3 4.2.3.1	Fastening <ul style="list-style-type: none"> – loose 	Detach wagon	5
	4.2.3.2	– some bolts or rivets loosened but axle guard still secure	M	3
	4.2.4 4.2.4.1	Crack <ul style="list-style-type: none"> – running over more than $\frac{1}{4}$ of horizontal cross-section 	Detach wagon	4
	4.2.4.2	– running over $\leq \frac{1}{4}$ of horizontal cross-section	K	3
	4.2.4.3	– close to or running towards a fastening point, regardless of length of crack	Detach wagon	5

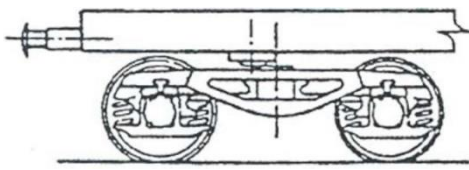
Component	Code no.	Irregularities/Criteria/Notes	Action to be taken	Irregularity class
Axle guard tie bar	4.3			
	4.3.1	Missing, broken, visibly distorted, loose	Detach wagon	4
Axle guard check plate	4.4			
	4.4.1	Check plate missing Bogie wagon		
	4.4.1.1	– one check plate missing per axle	K	3
	4.4.1.2	– more than one check plate missing	Detach wagon	4
	4.4.1.3	Axle wagon – one check plate missing	Detach wagon	5
Hard manganese wear plate on Y bogies or derivative designs	4.4.2	Plate displaced or missing	Detach wagon	4
Suspension bracket (axle wagon)	4.5			
	4.5.1	Loose, cracked, broken, or distorted – space between bracket and sole-bar – half or more of the fastening elements missing or broken	Detach wagon	5
Connection between bogie and underframe	4.6			
	4.6.1			
	4.6.1.1	Defective, connecting and fastening elements broken, missing or ineffective <ul style="list-style-type: none"> • bogie displaced 	Detach wagon	5
	4.6.1.2	Locking device for the bogie pivot kingpin missing or ineffective or pin missing	Detach wagon	4

Component	Code no.	Irregularities/Criteria/Notes	Action to be taken	Irregularity class
Earthing strap	4.6.2			
	4.6.2.1	One or more earthing straps ineffective (missing, damaged or loose) <ul style="list-style-type: none"> Fastening points indicate that straps should be present 	K	3
	4.6.2.2	All earthing straps ineffective <ul style="list-style-type: none"> Fastening points indicate that straps should be present 	Rectify. If not possible, detach wagon	3
Bogie frame	4.7			
	4.7.1	Component cracked or visibly distorted	Detach wagon	4
	4.7.2	Component broken	Detach wagon	5
	4.7.3	Bogie frame assembly Screw fastening on bogie frame		
	4.7.3.1	1 screw missing/broken on a single axle	Replace. If not possible, K + R1 (isolate brake)	3
	4.7.3.2	2 screws missing/broken on a single axle	Detach wagon	5
Side bearers and side bearer spring	4.8			
	4.8.1	Side bearer broken		
	4.8.1.1	– with no parts missing	K	4
	4.8.1.2	– with part(s) missing	Detach wagon	5
	4.8.2	Side bearer spring broken	Detach wagon	4
	4.8.3	Incomplete or loose side bearer fastening	K	3
Friction surface(s) of damper system	4.9			
	4.9.1	Lubricated	Detach wagon	4

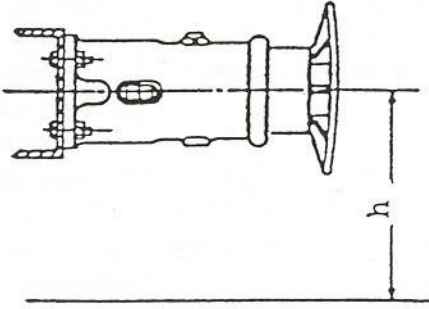
Component	Code no.	Irregularities/Criteria/Notes	Action to be taken	Irregularity class
Buffing and draw gear	5			
Buffers	5.1			
Buffer types	5.1.1	Visibly different buffer types at any wagon end <ul style="list-style-type: none"> Note buffer head⁵ 	K	4
Buffer height	5.1.2	Exceeding tolerance range <ul style="list-style-type: none"> – $h < 940$ mm (980 mm in the case of coaches) – $h > 1065$ mm • significant difference in buffer height at coupled wagon ends 	Detach wagon	5
Buffer head	5.2			
	5.2.1	Missing, broken, distorted such that it is no longer functional, rectangular plate twisted	Detach wagon	5
	5.2.2	Fastening on plunger:		
	5.2.2.1	– one third or more rivets or bolts loose	Detach wagon	4
	5.2.2.2	– fewer than one third of rivets or bolts loose	K	3

⁵ Two buffers are to be attached to each end of the wagon, each with the same spring system, buffer category, buffer head size, stroke, and housing type. Buffers that are different only with regard to the buffer head material or due to a replaced buffer head are regarded as identical. The total length of both buffers at each end of the vehicle must be equal.

Component	Code no.	Irregularities/Criteria/Notes	Action to be taken	Irregularity class
Buffer head <i>(continued)</i>	5.2.3	Surfaces in contact		
	5.2.3.1	– not lubricated, if both buffer heads are made of metal	Lubricate. If not possible, detach wagon	5
	5.2.3.2	– more than 2 sharp-edged grooves measuring > 3 mm in depth and > 50 mm in length	Detach wagon	5
	5.2.4	Buffer head insert or plastic plate		
	5.2.4.1	– broken, cracked right through, missing	Detach wagon	5
	5.2.4.2	– Crumbling/melding > 3 mm in depth and > 25 mm in length	K	4
	5.2.4.3	– Fastening: 2 or more loose/missing bolts	Detach wagon	5
Plunger	5.3			
	5.3.1	Missing, broken	Detach wagon	5
	5.3.2	Cracked at the transition to buffer head	Detach wagon	5
	5.3.3	Function jeopardised		
	5.3.3.1	Cracked longitudinally and no longer capable of guiding buffer casing	Detach wagon	5
	5.3.3.2	More than 2 grooves distributed over the circumference, each > 2 mm in depth, sharp-edged, and > 60 mm in length	Detach wagon	5
Buffer casing	5.4			
	5.4.1	Missing, broken	Detach wagon	5
	5.4.2	Cracked at transition to buffer base	Detach wagon	5
	5.4.3	Function jeopardised		
	5.4.3.1	Cracked longitudinally and no longer capable of guiding plunger	Detach wagon	5
	5.4.3.2	More than 2 grooves distributed over the circumference, each > 2 mm in depth, sharp-edged, and > 60 mm in length	Detach wagon	5

Component	Code no.	Irregularities/Criteria/Notes	Action to be taken	Irregularity class
Buffer casing <i>(continued)</i>	5.4.4	Fastening of buffer casing defective:		
	5.4.4.1	– 2 or more bolts loose <ul style="list-style-type: none"> • play between buffer casing and headstock 	Tighten bolts + M, if not possible, detach wagon	5
	5.4.4.2	– 1 bolt missing	Replace + M, if not possible, detach wagon	3
	5.4.4.3	– 1 bolt loose	Tighten + M, if not possible, K	3
Buffer spring and anti-crash components	5.5			
	5.5.1	Buffer so slack that it can be de-pressed by hand: <ul style="list-style-type: none"> – one buffer, by more than 15 mm – both buffers at the same end 	Detach wagon	4
	5.5.2	Anti-crash components triggered <ul style="list-style-type: none"> • buffer length visibly reduced • yellow marker arrow partly or completely absent⁶ • plunger damaged or deformed⁶ • indicator missing or distorted⁶ 	Detach wagon	5
	5.5.3	Anti-crash component warning mark missing or incomplete	Detach wagon	4
Screw coupler	5.6			
	5.6.1	Inoperative		
	5.6.1.1	Damaged or part missing	Rectify or use a different screw coupling + K, if not possible, detach wagon	3
	5.6.1.2	Lack of lubricant and jammed	Rectify or use a different screw coupling + K, if not possible, detach wagon	3
	5.6.2	Hook for hanging coupler damaged, inoperative or missing	M	3
	5.6.3	Coupler unhooked	Hook into position and tie up if necessary	3

⁶ Depending on buffer type

Component	Code no.	Irregularities/Criteria/Notes	Action to be taken	Irregularity class
Draw hook	5.7			
	5.7.1	Inoperative or in poor condition		
	5.7.1.1	– broken, cracked (including tip)	If possible, use the other coupling, K. If not possible, detach wagon	3
	5.7.1.2	– twisted	K	3
	5.7.2	- reserved -		
Other draw gear parts	5.8			
	5.8.1	Other draw gear parts damaged <ul style="list-style-type: none"> – length of coupler such that the buffer heads cannot be brought into contact with each other – drawbar broken, cracked or distorted – muffs, bolts, or keys broken, cracked, missing – spring inoperative <ul style="list-style-type: none"> • clearly abnormal projection of draw hook from draw hook guide 	Detach wagon	4
	5.8.2	Faulty coupling on the train	Adjust coupling	4
Long-stroke damper (e.g., on container wagons)	5.9			
	5.9.1	Sliding element not in mid-position with respect to wagon underframe <ul style="list-style-type: none"> • the two headstocks are at different distances from wagon body 	Detach wagon	5
	5.9.2	Danger marking (diagonal black bands on yellow background) missing on overlapping wagon surfaces on which the front part is liable to be displaced in relation to the underframe during impact (impact absorption devices, etc.)	Detach wagon	4

Component	Code no.	Irregularities/Criteria/Notes	Action to be taken	Irregularity class
Wagon body	6			
Wagon body in general	6.1			
Markings on wagons	6.1.1	Missing, illegible or incomplete		
	6.1.1.1	– wagon number ⁷	Detach wagon	4
	6.1.1.2	– “RIV” sign, “TEN” + “GE” or acceptance marking (“TEN” + “G1”, country acronym in approval plate) ⁷ or	Detach wagon	4
	6.1.1.3	– agreement plate (if showing exchange codes 41, 43, 45, 81, 83 or 85) ⁷ or acceptance marking (“TEN” + “CW” + country acronym in approval plate) ⁷	Detach wagon	4
	6.1.1.4	– tare weight ⁷	Detach wagon	4
	6.1.1.5	– Holding force of parking brake ⁷	Detach wagon	4
	6.1.1.6	– load limits ⁷	Detach wagon	4
	6.1.1.7	– capacity of tank wagons ⁷	Detach wagon	4
	6.1.1.8	– both the VKM and full address of wagon keeper ⁷	Detach wagon	4
	6.1.1.9	– length-over-buffers of wagon ⁷	Detach wagon	4
	6.1.1.10	– “high voltage” warning sign on wagons with step or ladder access up to a height > 2 m above rail level	Detach wagon	4
	6.1.1.11	– indication of compatibility with ILUs on carrying wagon ⁷	Detach wagon	4
	6.1.1.12	- reserved -		
	6.1.1.13	- reserved -		

⁷ If this irregularity is only found on one side of the wagon: affix K

Component	Code no.	Irregularities/Criteria/Notes	Action to be taken	Irregularity class
Overhaul	6.1.2	Overhaul marking		
	6.1.2.1	Inscription on the maintenance plate missing, incomplete or illegible ⁷	Detach wagon	4
	6.1.2.2	Maintenance plate (Possible extension of validity if wagons marked "+ 3M") Validity expires in 15 days or less	K	3
	6.1.2.3	Validity has expired ≤ 6 months	Proceed in accordance with point 1 of Annex 8	4
	6.1.2.4	Validity has expired > 6 months	Proceed in accordance with point 1 of Annex 8	4
Framework	6.1.3	Part of framework damaged		
	6.1.3.1	– without fouling the loading gauge	K	3
	6.1.3.2	– with fouling the loading gauge	Detach wagon	5
Walls	6.1.4			
	6.1.4.1	Side plank missing, broken, split or coming undone; wall panel holed, broken	K	3
	6.1.4.2	Risk of damage to load due to humidity; risk of loss of load	Rectify if necessary + K. If not possible, detach wagon	4
Floors	6.1.5	Floor damaged		
	6.1.5.1	– with no risk of loss of load	K	3
	6.1.5.2	– with risk of loss of load	Rectify if necessary + K. If not possible, detach wagon	4

⁷ If this irregularity is only found on one side of the wagon: affix K

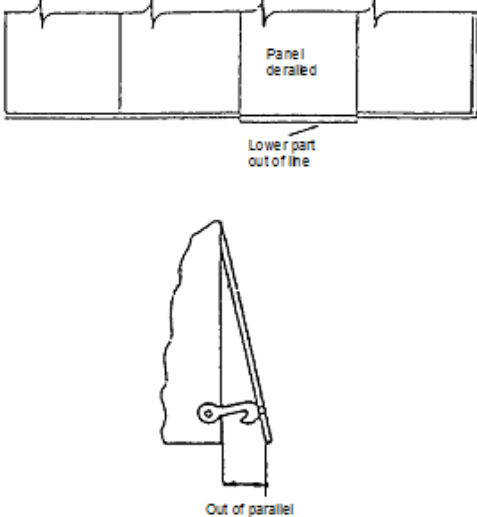
Component	Code no.	Irregularities/Criteria/Notes	Action to be taken	Irregularity class
Doors and sliding walls	6.1.6 6.1.6.1	Not fully closed or not fastened	Close and/or secure. If not possible, fasten + K. If fastening not possible, detach wagon	5
	6.1.6.2	Missing or derailed <ul style="list-style-type: none"> • abnormal position in relation to its frame 	If putting back in position is possible, fasten + K. If not possible, detach wagon	5

Component	Code no.	Irregularities/Criteria/Notes	Action to be taken	Irregularity class
		<p>guide rail</p> <p>claw slipped out of guide rail</p> <p>closing level not returned to vertical position</p> <p>panel not closed</p> <p>alignment fault</p> <p>a</p> <p>b</p> <p>a > b</p> <p>Door derailed; rollers no longer on rail</p>		

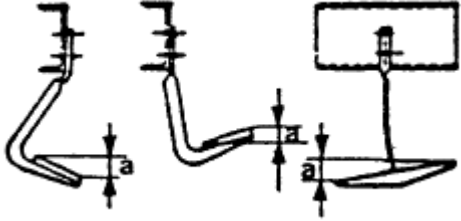
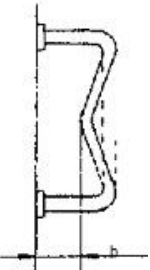
Component	Code no.	Irregularities/Criteria/Notes	Action to be taken	Irregularity class	
Doors and sliding walls <i>(continued)</i>	6.1.6.3	Guiding or locking elements in poor condition – door frame, hinges, locks, latch hooks, handles missing, broken; dislocated, deformed	Temporary repair + K. If not possible, detach wagon	3	
	6.1.6.4	– safety hazard or risk of loss of load		5	
	6.1.6.5	Doors broken or warped – no risk of fouling the gauge or losing the load	Temporary repair + K. If not possible, detach wagon	3	
	6.1.6.6	– risk of gauge being fouled or loss of load		5	
	Various parts (steps, handles, ladders, gangways, guard rails, inscription plates and others)	6.1.7			
		6.1.7.1	Ladders, gangways, guard rails in poor condition, unusable	K	4
6.1.7.2		Steps: missing	K	4	
6.1.7.3		Steps: damage representing a safety hazard for staff, torn off or deformed beyond tolerated limit ($a > 80$ mm) 	Detach wagon	4	
6.1.7.4	Handles: missing, damage representing a safety hazard for staff, torn off or deformed beyond tolerated limit ($b < 60$ mm) 	Temporary repair + M. If not possible, detach wagon	4		

Component	Code no.	Irregularities/Criteria/Notes	Action to be taken	Irregularity class
Various parts (steps, handles, ladders, gangways, guard rails, inscription plates and others) <i>(continued)</i>	6.1.7.5	Inadequate securing of <ul style="list-style-type: none"> – inscription plates – folding plates – label holders 	Temporary repair + M. If not possible, detach wagon	4
	6.1.7.6	Missing <ul style="list-style-type: none"> – inscription plates – folding plates – label holders 	Temporary labels + K. If not possible, detach wagon	3
	6.1.7.7	Loose wagon accessories missing or incomplete	M	3
	6.1.7.8	Loose wagon accessories not secured	Fasten	4
	6.1.7.9	Signal brackets, rope eyes missing, unfit for use	M	3
Internal fittings⁸	6.1.8	Defective internal fittings: <ul style="list-style-type: none"> – holding arm – guide rail – loading cradle – loops, hooks, eyelets – dividing walls 	Temporary repair, rectify using additional fastenings + M. If not possible, detach wagon	3
	6.1.8.1			5
	6.1.8.2	Wagon with fastening equipment (see also no. 6.6.7), car carrying wagon, wheel scotches (see also no. 6.6.5.2)		
Covered wagons Ventilation flaps	6.2			
	6.2.1	Missing, damaged		
	6.2.1.1	– without any risk of damage due to humidity or fouling of the loading gauge	Rectify + K. If not possible, detach wagon	3
	6.2.1.2	– with risk of damage due to humidity or fouling of the gauge	Detach wagon	5

⁸ Defective internal fittings: Observed during a special inspection separate to the technical inspection

Component	Code no.	Irregularities/Criteria/Notes	Action to be taken	Irregularity class
Control gear, shutter retaining bracket	6.2.2	Unhooked, distorted, loose	Rectify + K. If not possible, detach wagon	3
	6.2.2.1	– without any risk of fouling the gauge		
	6.2.2.2	– with risk of fouling the gauge		5
Roof and weatherboard	6.2.3	Roof cover or weatherboard loose, compromising safety or water tightness	Detach wagon	4
	6.2.4	Opening roof	Close and lock roof if necessary + K. If not possible, detach wagon	5
	6.2.4.1	– not fully closed, not secured		
	6.2.4.2	– derailed	Set back in rails and secure; otherwise, detach wagon	5
	6.2.4.3	– control mechanism missing, distorted, ineffective	K	4
Open wagons Side walls or end flaps	6.3			
	6.3.1	Damaged	M	3
	6.3.1.1	– with no risk of losing the load or fouling the gauge		
	6.3.1.2	– with risk of losing load	Rectify + K. If not possible, detach wagon	4
6.3.1.3	– with risk of fouling the gauge	Rectify + K. If not possible, detach wagon	5	
Closing and operating gear of end flaps	6.3.2	Pins, camshafts, retaining hooks, shaft supports, etc. missing, broken, cracked, inoperative	Repair temporarily + K. If not possible, detach wagon	3
	6.3.2.1	– without compromising safety		
	6.3.2.2	– compromising safety		5

Component	Code no.	Irregularities/Criteria/Notes	Action to be taken	Irregularity class			
Cantrail	6.3.3	Broken or deformed	Rectify + K. If not possible, detach wagon	3			
	6.3.3.1	– with no risk of fouling the gauge					
	6.3.3.2	– with risk of fouling the gauge		5			
Flat wagons Drop sides	6.4	Folded down and not secured	Secure. If not possible, detach wagon	5			
	6.4.1						
	6.4.1.1						
	6.4.1.2				Folded but not authorised in table 3 of the Loading Guidelines	Raise. If not possible, detach wagon	5
	6.4.1.3				Distorted with no risk of losing load or fouling the gauge	M	3
	6.4.1.4				Holed or distorted with risk of losing load	Rectify + K. If not possible, detach wagon	4
6.4.1.5	Distorted with risk of fouling the gauge	Rectify + K. If not possible, detach wagon	5				
Hinges, pins, securing bolts	6.4.2	Missing, inoperative, broken	Repair temporarily + K. If not possible, detach wagon	3			
	6.4.2.1	– but not compromising safety or involving risk of loss of load					
	6.4.2.2	– compromising safety or involving risk of loss of load		4			
Stanchions - detachable - pivoting - retractable	6.4.3	Missing and necessary to secure load	If not possible to rectify, detach wagon	5			
	6.4.3.1						
	6.4.3.2	Deformed and fouling the gauge		5			
	6.4.3.3	Crack or break in stanchion or in its mounting or fixing device		If presence of stanchion is required: detach wagon; otherwise, M	4		
	6.4.3.4	Stanchion chains hanging loose		Rectify	4		
	6.4.3.5	Stanchion fastening ineffective		Fasten, K. If not possible, detach wagon	4		

Component	Code no.	Irregularities/Criteria/Notes	Action to be taken	Irregularity class
Bolsters	6.4.4 6.4.4.1	Broken, timber bearing surface or joint unfit for use	M	3
	6.4.4.2	Loose bolsters not secured by side stanchions or load	Rectify; otherwise detach wagon	4
Tank wagons Tank cradle	6.5 6.5.1 6.5.1.1	Crack extending > ¼ across the cross-section } Crack in the weld seams }	If empty: K If loaded, detach wagon	4
	6.5.1.2			4
	6.5.1.3	Up to 10% of the bolts or rivets securing tank body to cradle missing	K	4
	6.5.1.4	More than 10% of the bolts or rivets securing tank body to cradle missing	Detach wagon	4
	Tank	6.5.2 6.5.2.1	Not sealed: leaks or risk of loss of load – Odours – Traces of recent or persistent leakage	Have sealed + K. For RID: to have cleaned by qualified personnel. If not possible, detach wagon
6.5.2.2		Distorted with sharp edges but no risk of loss of load	K	4
6.5.2.3		Test date expired, RID load Without “L” marking Tank full:	K	4
		– Deadline has expired ≤ 1 month		
6.5.2.4		– Deadline has expired > 1 month	Detach wagon	5
6.5.2.5		Tank empty, not cleaned:	K	4
		– Deadline has expired ≤ 1 month – or > 1 month		
6.5.2.6		With “L” marking Tank full:	Detach wagon	5
		– Deadline has expired > 3 months		
6.5.2.7	Tank empty, not cleaned: – Deadline has expired > 3 months	K	4	

Component	Code no.	Irregularities/Criteria/Notes	Action to be taken	Irregularity class
Tank equipment	6.5.3	Tank cladding, sunroof, insulation		
	6.5.3.1	– damaged	K	4
	6.5.3.2	– loose	Detach wagon	5
	6.5.4	- reserved -		
Reinforcement, filling and emptying equipment, underneath	6.5.5			
	6.5.5.1	Loss of load	Rectify. If not possible, detach wagon	5
	6.5.5.2	- reserved -		
	6.5.5.3	Valves or spouts defective	Detach wagon	4
	6.5.5.4	Screw caps must be tightly sealed and must not be missing (except for outside gas pipes) – RID load ⁹	Rectify. If not possible, detach wagon	4
	6.5.5.5	– non-RID load	Rectify. If not possible, M	3
	6.5.5.6	Blind flange missing	Detach wagon	4
	6.5.5.7	Securing bolt of the blind flange – RID load ⁹ , one or more securing bolts missing or loose	Detach wagon	4
	6.5.5.8	– non-RID load, one securing bolt missing or loose	Rectify. If not possible, K	3
	6.5.5.9	– non-RID load, several securing bolts missing or loose bottom valve indicator device not in “closed” position on both sides	Rectify. If not possible, detach wagon	4
6.5.5.10	Bottom valve indicator device not showing “closed” on both sides – loaded wagons, and empty wagons that have not been cleaned (RID load ⁹)	Close bottom valve. If not possible, detach wagon	5	

⁹ Clarification: pay attention to the hazard warning labels

Component	Code no.	Irregularities/Criteria/Notes	Action to be taken	Irregularity class
Reinforcement, filling and emptying equipment, underneath <i>(continued)</i>	6.5.5.11	– empty wagons (non-RID load)	Close bottom valve. If not possible, K	3
	6.5.5.12	Bottom valve emergency control device screwed in (tank-mounted valve open)	Detach wagon	5
	6.5.5.13	Filling and emptying equipment open	Rectify. If not possible, detach wagon	5
	6.5.5.14	Visible locking devices ineffective	Rectify. If not possible, detach wagon	4
Reinforcement, filling equipment, above	6.5.6 6.5.6.1	Loss of load or gas near the upper reinforcements (does not concern ventilation devices) <ul style="list-style-type: none"> • Odours • Signs of recent or persistent leakage 	Detach wagon	5
	6.5.6.2	Dome cover open or missing	Close or have closed. If not possible, detach wagon	5
	6.5.6.3	Other upper reinforcements not closed	Close or have closed. If not possible, detach wagon	4
	6.5.7	- reserved -		

Component	Code no.	Irregularities/Criteria/Notes	Action to be taken	Irregularity class
Reinforcement, filling equipment, above	6.5.6			
	6.5.6.1	Loss of load or gas near the upper reinforcements (does not concern ventilation devices) <ul style="list-style-type: none"> • Odours • Signs of recent or persistent leakage 	Detach wagon	5
	6.5.6.2	Dome cover open or missing	Close or have closed. If not possible, detach wagon	5
	6.5.6.3	Other upper reinforcements not closed	Close or have closed. If not possible, detach wagon	4
	6.5.7	- reserved -		

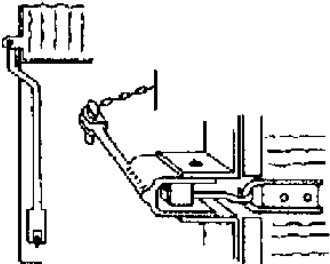
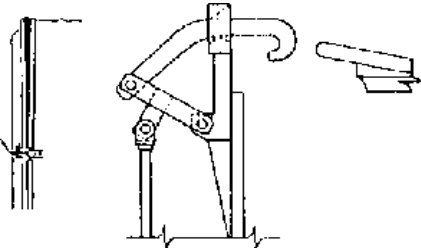
Component	Code no.	Irregularities/Criteria/Notes	Action to be taken	Irregularity class
<p>Wagons with special fittings</p> <p>Wagons with mechanical sheeting (e.g., Rils, Tams)</p>	6.6			
	6.6.1			
	6.6.1.1	<p>Mechanical sheeting not properly closed and locked</p> <ul style="list-style-type: none"> indicator visible → side closing system open <p style="text-align: center;">Side locking system</p>  <ul style="list-style-type: none"> end hoops inclined → locking system not engaged <p style="text-align: center;">Top locking system</p> 	Close. If not possible, detach wagon	5
	6.6.1.2	Tarpaulin – tarpaulin torn, holed ≤ 30 mm	Rectify	3
	6.6.1.3	Tarpaulin – tarpaulin torn, holed > 30 mm	Detach wagon	5
6.6.1.4	Tarpaulin – eyelet missing, torn off	Rectify + K. If not possible, detach wagon	4	

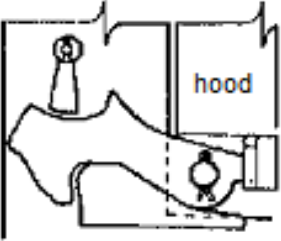
Component	Code no.	Irregularities/Criteria/Notes	Action to be taken	Irregularity class
Wagons with telescopic hood (e.g. Shimms)	6.6.2 6.6.2.1	Hood not locked 	Lock. If not possible, make secure+ K; otherwise detach wagon	5
	6.6.2.2	External hood off the rail	Detach wagon	5
Flat bogie wagons for transport of road vehicles (e.g., Saad)	6.6.3 6.6.3.1	Moveable headstocks damaged	K	4
	6.6.3.2	Moveable headstocks not locked into place on both sides	Lock. If not possible, detach wagon	5
	6.6.3.3	Seating device, seating device bolt, securing chains or chain eyelets not working	Rectify. If not possible, detach wagon	4
	6.6.3.4	Wheel scotches damaged	M	3
ACTS ^{*)} carrier wagons with swivel frame <small>^{*)} Roll on/off container transport system</small>	6.6.4 6.6.4.1	Swivel frame damaged	K	4
	6.6.4.2	Locking device preventing the frame from swiveling ineffective or unlocked – locking lever not secured or locked in position ¹⁰ – stanchions not in position and not secured ¹⁰ – snap lock (safety bolt) defective and handle in unlocked position ¹⁰	Secure and lock. If not possible, detach wagon	5
	6.6.4.3	Pneumatic monitoring system on the swivel lock not in service and not labelled	Put in service	4

¹⁰ Rules for the use of the swivel frame system to be complied with

Component	Code no.	Irregularities/Criteria/Notes	Action to be taken	Irregularity class
ACTS *) carrier wagons with swivel frame *) Roll on/off container transport system (continued)	6.6.4.4	Pneumatic monitoring system on the swivel lock triggered	Check swivel lock. If no fault found, disconnect monitoring system + K	3
	6.6.4.5	Device to prevent container lifting ineffective – locking lever not secured or locked in position ¹⁰	Secure. If not possible, detach wagon	5
	6.6.4.6	Device to prevent containers moving ineffective ¹⁰	Detach wagon	5
Car-carrying wagons	6.6.5			
	6.6.5.1	Damage to lifting and lowering equipment, crossing gangways and footplates	K	4
	6.6.5.2	Damage to wheel scotch, wheel guides or crank handle	M	3
	6.6.5.3	End boards and crossing gangways – where required – not raised and secured	Rectify. If not possible, detach wagon	4
	6.6.5.4	Upper loading deck, indicator device not engaged	Secure	4
	6.6.5.5	Upper loading deck not secured	Secure. If not possible, detach wagon	5
	6.6.5.6	Upper loading deck not resting on supporting bracket (suspended by cables)	Rectify. If not possible, detach wagon	5
6.6.5.7	Upper deck loaded but fouling the gauge	Detach wagon	5	

¹⁰ Rules for the use of the swivel frame system to be complied with

Component	Code no.	Irregularities/Criteria/Notes	Action to be taken	Irregularity class
Car-carrying wagons (continued)	6.6.5.8	Gangways above central axles not fully maneuverable on loaded wagons <ul style="list-style-type: none"> distance: ≤ 100 mm between wheel of vehicle and gangway 	Rectify. If not possible, detach wagon	5
	6.6.5.9	Mechanical damage to support and fastening of crossover plates on central axles <ul style="list-style-type: none"> distorted, breakage, cracking, missing parts – empty wagon	K	4
	6.6.5.10	– loaded wagon	Detach wagon	5
Self-discharging wagons (e.g., Tads, Fals, Tals, ...)	6.6.6	Discharge valve not closed and/or not locked		
	6.6.6.1	– empty wagon with axial flap	Close and lock. If not possible, K	3
	6.6.6.2	– loaded wagon with axial flap	Close and lock. If not possible, detach wagon	4
	6.6.6.3	– empty wagon with lateral flap	Close and lock. If not possible, detach wagon	4
	6.6.6.4	– loaded wagon with lateral flap	Close and lock. If not possible, detach wagon	4
Wagons with securing equipment (e.g., Snps, Roos, Ealos)	6.6.7			
	6.6.7.1	Unused securing equipment not properly or adequately fixed, stowed or secured	Rectify. If not possible, make safe + K	4

Component	Code no.	Irregularities/Criteria/Notes	Action to be taken	Irregularity class
Gear for securing load units (ILU) on carrier wagons	6.7			
	6.7.1	Seating device or spigot distorted or defective		
	6.7.1.1	– seating device not in use	K	3
	6.7.1.2	– seating device in use	Rectify +K. If not possible, detach wagon	5
	6.7.1.3	– spigot not in use	K	3
	6.7.1.4	– spigot in use	Rectify +K. If not possible, detach wagon	5
	6.7.2	Coupling pin of trailer not locked into trestle	Lock. If not possible, detach wagon	5
	6.7.3	Seating device not in use and not locked	Place seating device in its end position and lock. If not possible, secure temporarily + K	3
	6.7.4	Seating adjustment device unlocked and potentially fouling the gauge	Push in and secure seating adjustment device. If not possible, detach wagon	5
	6.7.5	Moving parts not properly secured (e.g., retractable spigots, handrails for shunters, etc.)		
	6.7.5.1	– no risk of fouling the gauge	Rectify. If not possible, secure provisionally	3
	6.7.5.2	– Risk of fouling the gauge	Rectify. If not possible, detach wagon	5
	6.7.6	Anti-crash system of seating device triggered, damaged elements		
	6.7.6.1	– in use	Detach wagon	5
6.7.6.2	– not in use	K, close emergency stop cock	4	

Component	Code no.	Irregularities/Criteria/Notes	Action to be taken	Irregularity class
Loads and intermodal loading units (ILU)	7			
Load in general Distribution of the load (wagon)	7.1			
	7.1.1	Load visibly displaced <ul style="list-style-type: none"> lashing cords broken load not positioned properly on blocks not centrally positioned 	Detach wagon	5
	7.1.2	Load unevenly distributed (3.3), body not horizontal <ul style="list-style-type: none"> different buffer heights (3.5) unequal suspension spring play (3.5) 	Detach wagon, proceed as per Annex 8, point 3	5
Packing, load fastening	7.1.3	Packages, bundles, bales, stacks coming apart or not properly tied together (1.5)	Detach wagon	4
	7.1.4	Inadequate binding of narrow, cylindrical objects (1.5)	Detach wagon	4
Maximum permissible dimensions of load	7.1.5			
	7.1.5.1	Unauthorised fouling of the gauge (4.1)	Detach wagon	5
	7.1.5.2	Fouling of the gauge not indicated <ul style="list-style-type: none"> U label missing 	Detach wagon	5
Reserved spaces	7.1.6	Encroachment of reserved spaces <ul style="list-style-type: none"> load projecting beyond the head-stock (4.2) 	Detach wagon	5
Load limits	7.1.7			
	7.1.7.1	Exceeding of load limits (3.2), visually detected: <ul style="list-style-type: none"> different buffer heights insufficient distance between spring buckle and solebar	Detach wagon. Proceed as per point 2 of Annex 8	5
	7.1.7.2	Exceeding of load limits (3.2), detection by: <ul style="list-style-type: none"> discrepancy between consignment data and load limit marked on wagon measuring or diagnostic devices	Detach wagon. Proceed as per point 2 of Annex 8	5

Component	Code no.	Irregularities/Criteria/Notes	Action to be taken	Irregularity class
Buffer wagons	7.1.8	Vertical and horizontal clearances not respected between loads or between buffer wagon and load (4.3)	Detach wagon	5
Sheeting, nets	7.1.9	Inadequate, defective or secured with non-compliant fastening equipment (6.1, 6.2)	Rectify. If not possible, detach wagon	4
Loss of load	7.1.10	Loss of load (except tank wagons/tank containers), excluding other restrictions (See also codes 6.1.4.2, 6.1.5.2, 6.1.6.4, 6.1.6.6, 6.3.1.2, 6.4.1.4, 6.4.2.2 and 7.5.5.3)	Rectify. If not possible, detach wagon	5
Load securing equipment	7.2			
Wagon walls or sides	7.2.1	Load projecting beyond the walls and sides and inadequately secured (5.4.1)	Detach wagon	5
	7.2.2	Load clearly pressing against walls, sides or doors and thus hindering their functioning, with risk of damage or operating hazard (2.3)	Detach wagon	4
Stanchions	7.2.3			
	7.2.3.1	Load inadequately secured by stanchions (2.5 and 5.4.1)	Detach wagon	5
	7.2.3.2	Fastenings between opposite stanchions missing (2.5)	Detach wagon	5
	7.2.3.3	Load pressing up against and bending stanchions (2.5)	Detach wagon	5
	7.2.3.4	Load which is heavy and/or which may damage side stanchions in the event of longitudinal displacement, pressing up against stanchions (2.5)	Detach wagon	4

Component	Code no.	Irregularities/Criteria/Notes	Action to be taken	Irregularity class
Scotches fastened with nails	7.2.4	Non-compliant (5.4.3) – insufficient – ineffective – incorrectly fastened on the floor	Detach wagon	5
Direct or indirect fastenings (lashing)	7.2.5	Non-compliant (5.4.4, 5.5.4)		
	7.2.5.1	– unsuitable or unauthorised material	Detach wagon	5
	7.2.5.2	– incorrectly or inadequately fastened	Rectify. If not possible, detach wagon	5
	7.2.5.3	– slack	Rectify. If not possible, detach wagon	4
Bolsters, timbers, stretchers, fastening gear	7.2.6			
	7.2.6.1	Non-compliant (5.5.5, 5.6.2, 5.8.1) – damaged – poorly chosen – inadequate – incorrectly arranged – loose	Detach wagon	5
	7.2.6.2	Auxiliary loading equipment or fastening gear not removed	Rectify	3
Load residues	7.2.7	Load residues which may compromise safety not removed	Remove. If not possible, detach wagon	5
Loading and load securing methods	7.3			
	General	7.3.1	Load unstable and wrongly secured (5.1)	Detach wagon
Goods subject to lifting by airflow (e.g., light scrap, thin boards, bulk goods)	7.3.2	Covering missing or inadequate (5.2.1, 5.3.2)	Detach wagon	5

Component	Code no.	Irregularities/Criteria/Notes	Action to be taken	Irregularity class
Goods which may fall off on account of vehicle vibrations and impacts (wire metal trellis-work, metal filings etc.)	7.3.3 7.3.3.1	Insufficient clearance between goods and top edge of walls of the wagon (5.2.2) <ul style="list-style-type: none"> • load protruding beyond top edges of walls 	Detach wagon	5
	7.3.3.2	Dome-shaped load too high (5.3.1)	Detach wagon	5
Stacked goods	7.3.4	Wrongly stacked (5.8) <ul style="list-style-type: none"> – uneven distribution over floor – too high – poorly stacked – inadequate bindings – insufficient clearance between a load liable to sway and loading gauge – cylindrical loads inadequately secured 	Detach wagon	5
Load with inadequate supporting area, liable to damage the wagon floor	7.3.5 7.3.5.1	Scotches missing or insufficient (2.2) <ul style="list-style-type: none"> • floor damaged 	K	3
	7.3.5.2	Excessive concentration of load (3.4) <ul style="list-style-type: none"> – scotches in place, unsuitable material used – scotches in place, dimensions insufficient pronounced deflection of wagon underframe	Detach wagon, proceed as per Annex 8, point 3	5
Load liable to tip	7.3.6	Not secured against overturning (5.7)	Detach wagon	5
Tilted load	7.3.7	Insufficiently supported (5.7)	Detach wagon	5
Load liable to roll	7.3.8	Inadequately secured against rolling (5.6.1, 5.6.2)	Detach wagon	5

Component	Code no.	Irregularities/Criteria/Notes	Action to be taken	Irregularity class
Load liable to slide lengthways	7.3.9			
	7.3.9.1	Laid on unsuitable – timbers – guide blocks – skids	Detach wagon	4
	7.3.9.2	Lateral guide-pieces missing or insufficient with risk of fouling the gauge or exceeding load limit (5.5)	Detach wagon	5
	7.3.9.3	Necessary clearances missing (5.5.2)	Detach wagon	3
	7.3.9.4	Necessary scope for sliding not limited (5.5.3)	Detach wagon	4
Special types of consignment Vehicles and machinery on wheels or caterpillar tracks/chains	7.4			
	7.4.1	Unsuitable scotch blocks and/or fastenings (5.6.3)	Rectify. If not possible, detach wagon	5
Moving parts of vehicles and machinery	7.4.2	Not properly immobilised		
	7.4.2.1	– no risk of fouling the gauge	Rectify. If not possible, detach wagon	3
	7.4.2.2	– risk of fouling the gauge	Detach wagon	5
Load supported on several wagons	7.4.3	Not loaded/secured according to requirements (5.9)	Detach wagon	5
Specific components of ILU, in particular those used for horizontal or vertical transshipment	7.5			
	7.5.1	Device for locking the dollies inoperative, defective or missing	Bind using wire. If not possible, detach wagon	4
	7.5.2	End doors on load units not securely closed or not properly locked		
	7.5.2.1	– door not closed	Close and lock. If not possible, detach wagon	5
	7.5.2.2	– Door not properly locked (not applicable to doors facing another load unit) if: <ul style="list-style-type: none"> • Upper cam not engaged or • Lower cam not engaged or • Horizontal locking lever not engaged 	Rectify, if not possible, detach wagon	4

Component	Code no.	Irregularities/Criteria/Notes	Action to be taken	Irregularity class
Specific components of ILU, in particular those used for horizontal or vertical transshipment (continued)	7.5.2.3	- reserved -		
	7.5.3	Lower corner casting damaged	Detach wagon	5
	7.5.4	Side wall, lining damaged, inadequately secured, unstable <ul style="list-style-type: none"> • hinges, securing bolts damaged, broken, missing • edge plank missing, broken, cracked or split; lining holed or broken 	Detach wagon	5
	7.5.5	Tarpaulin		
	7.5.5.1	– tarpaulin torn, holed ≤ 30 mm	Rectify	3
	7.5.5.2	– tarpaulin torn, holed > 30 mm	Detach wagon	5
	7.5.5.3	Danger of damage from humidity to the load or loss of load	Rectify, if not possible, detach wagon	4
	7.5.6	Tarpaulin, walls <ul style="list-style-type: none"> – locking, lashings inadequate – sheet; lack of tension/lock damages, inadequate 	Detach wagon	5
	7.5.7	Frame/load-bearing parts <ul style="list-style-type: none"> – cracked – broken 	Detach wagon	5
ILU tank Element connecting tank body and underframe	7.6			
	7.6.1			
	7.6.1.1	Crack > ¼ of the cross-section	Detach wagon	4
	7.6.1.2	Cracks in the weld seams	Detach wagon	4
Tank¹¹	7.6.2	Not tight: leaks or loss of load <ul style="list-style-type: none"> – Odours – Traces of recent or persistent leakage 	Have sealed. For RID: to have cleaned by qualified personnel. If not possible, detach wagon	5
	7.6.2.1			
	7.6.2.2	Distorted with sharp edges but no risk of loss of load	Rectify	4

¹¹ Clarification: moreover, verify 7. 8

Component	Code no.	Irregularities/Criteria/Notes	Action to be taken	Irregularity class
Tank equipment	7.6.3	Tank cladding, sunroof, insulation		
	7.6.3.1	– damaged	Rectify	4
	7.6.3.2	– loose	Detach wagon	5
Reinforcement, filling and emptying equipment, underneath	7.6.4			
	7.6.4.1	Loss of load	Rectify, if not possible, detach wagon	5
	7.6.4.2	Valves or spouts defective	Detach wagon	4
	7.6.4.3	Screw cap must be tightly sealed and not missing – RID load ¹²	Rectify. If not possible, detach wagon	4
	7.6.4.4	– non-RID load	Rectify. If not possible, detach wagon	3
	7.6.4.5	Blind flange missing	Detach wagon	4
	7.6.4.6	Securing bolt of the blind flange – RID load ¹² , one or more securing bolts missing or loose	Detach wagon	4
	7.6.4.7	– non-RID load, one securing bolt missing or loose	Rectify. If not possible, detach wagon	3
	7.6.4.8	– non-RID load, several securing bolts missing or loose	Rectify. If not possible, detach wagon	4
Reinforcement, filling and emptying equipment, underneath (continued)	7.6.4.9	Bottom valve indicator device not in “closed” position on both sides – loaded load units, and empty wagons that have not been cleaned (RID load ¹²)	Close bottom valve. If not possible, detach wagon	5
	7.6.4.10	– empty load unit (non-RID load)	Close bottom valve. If not possible, detach wagon	3
	7.6.4.11	Bottom valve emergency control device screwed in (tank-mounted valve open)	Detach wagon	5
	7.6.4.12	Filling and emptying equipment open	Rectify. If not possible, detach wagon	5

¹¹ Clarification: pay attention to the hazard warning labels

Component	Code no.	Irregularities/Criteria/Notes	Action to be taken	Irregularity class
Reinforcement, filling and emptying equipment, underneath <i>(continued)</i>	7.6.4.13	Non-efficient visible locking devices	Rectify. If not possible, detach wagon	4
Reinforcement, filling and emptying equipment, above	7.6.5 7.6.5.1	Loss of load or of gas near the upper reinforcements (does not concern ventilation devices) <ul style="list-style-type: none"> • Odours • Signs of recent or persistent leakage 	Detach wagon	5
	7.6.5.2	Dome cover open or missing	Close or have closed. If not possible, detach wagon	5
	7.6.5.3	Other upper reinforcements not closed	Close or have closed. If not possible, detach wagon	4
Loading of ILU	7.7			
	7.7.1	ILU too heavy for wagon	Detach wagon	5
	7.7.2	Corner castings not engaged on their respective spigots	Detach wagon	5
	7.7.3	Spigots of hinged support plates neither raised nor secured	Raise and secure. If not possible, detach wagon	5
Loading of ILU <i>(continued)</i>	7.7.4	Air suspension system of semi-trailer not emptied	Empty. If not possible, detach wagon	5
	7.7.5	Underrun bumpers of semi-trailer: not raised/pushed in, even in the absence of contact with carrier wagon <ul style="list-style-type: none"> – on recess wagons without compatibility codes – on recess wagons marked with one of the following compatibility codes: a, b, c or d 	Rectify (raise/push in and lock)	3
	7.7.6	Semi-trailer with P coding: contact between semi-trailer and wagon (other than wheels and trestle)	Rectify. If not possible, detach wagon	4

Component	Code no.	Irregularities/Criteria/Notes	Action to be taken	Irregularity class
Loading of ILU <i>(continued)</i>	7.7.7	Semi-trailer with N coding loaded on carrier wagon with wagon compatibility code N (Novatrans system): contact between parts of the semi-trailer and wagon (other than the wheels, skids and longitudinal members in the intended support areas)	Rectify. If not possible, detach wagon	4
	7.7.8	Incorrect scotching of wheels of semi-trailer	Rectify. If not possible, detach wagon	4
	7.7.9	Load displaced in the ILU <ul style="list-style-type: none"> deformation of sheeting 	Detach wagon	5
Marking, coding for intermodal transport	7.8			
	7.8.1	Valid coding missing or illegible	Detach wagon	5
	7.8.2	ILU incompatible with carrying wagon	Detach wagon	5
	7.8.3	Absence of CSC safety plate <ul style="list-style-type: none"> on ILUs with upper corner castings 	Detach wagon	4
	7.8.4	Missing warning sign "danger: high voltage" <ul style="list-style-type: none"> on ILUs with steps 	Detach wagon	4
Particular incidents	8			
Operating irregularities	8.1			
	8.1.1	Derailment	Detach, proceed following Annex 9, I+K	5
	8.1.2	Abnormal buffering impact	Detach, proceed following Annex 9, I+K	5
Other events	8.2			
	8.2.1	Flood and weather damage	Detach	5
	8.2.2	Damage from priming current <ul style="list-style-type: none"> wagon was in contact with catenary under high voltage 	Detach	5
	8.2.3	Fire	Detach	5

APPENDIX 9, ANNEX 2

Irregularity Classes

Class	Definition	Value
1	Insignificant irregularities having no effect on a wagon's fitness to run or on operating safety Not considered in the QMS system	0.002
2	Irregularities having small effect on a wagon's fitness to run Not considered in the QMS system	0.050
3	Minor irregularities Irregularities having a considerable effect on a wagon's fitness to run and irregularities having an impact on operations (missing or wrong markings)	0.125
4	Major irregularities Irregularities which render a wagon unfit to run or which jeopardise operations and irregularities which might result in injuries (freight train crews)	0.400
5	Critical irregularities Irregularities with serious consequences for operating safety and irregularities presenting an immediate risk to transport operations	1.000

-reserved-

APPENDIX 9, ANNEX 3

Size of samples as per ISO 2859 – Part I

Excerpt from Table 1: Code letters indicating size of samples

Batch size			General inspection level		
			I	II	III
2	to	8	A	A	B
9	to	15	A	B	C
16	to	25	B	C	D
26	to	50	C	D	E
51	to	90	C	E	F
91	to	150	D	F	G
151	to	280	E	G	H
281	to	500	F	H	J
501	to	1200	G	J	K
1201	to	3200	H	K	L
3201	to	10000	J	L	M
10001	to	35000	K	M	N
35001	to	150000	L	N	P
150001	to	500000	M	P	Q
500001	and	above	N	Q	R

Excerpt from Table 2-A: Simple sampling guidelines for standard inspections

Code letter for the sample size	AQL	1	2.5
	Sample size	Acceptance value for	
		Class 5	Class 4
A	2	0	0
B	3	0	0
C	5	0	0
D	8	0	0
E	13	0	1
F	20	0	1
G	32	1	2
H	50	1	3
J	80	2	5
K	125	3	7
L	200	5	10
M	315	7	14
N	500	-	-
P	800	-	-
Q	1250	-	-
R	2000	-	-

Overview I: Procedure for the inclusion of a train in an agreement

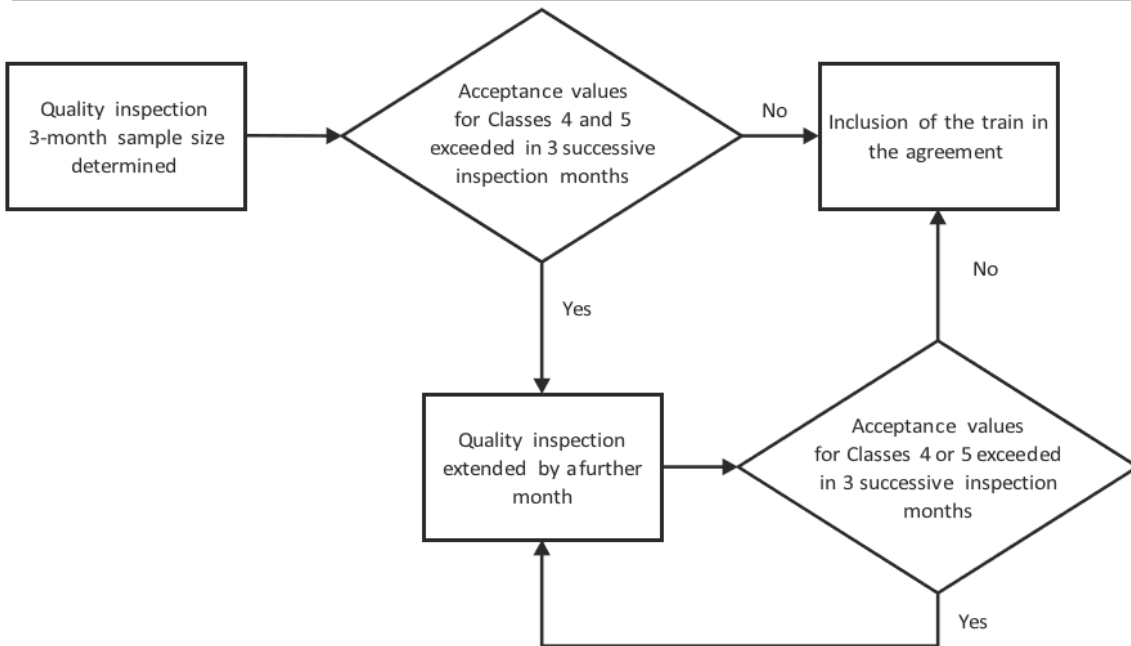

Overview II: Procedure for the exclusion of trains from an agreement

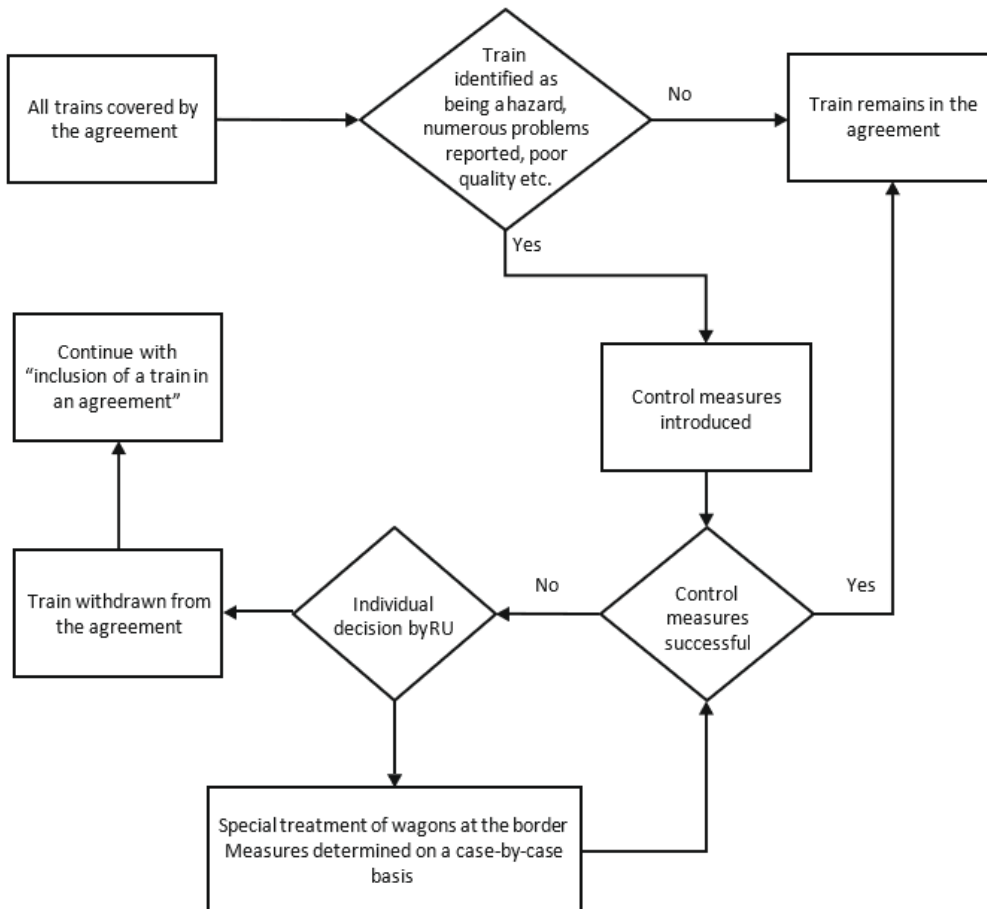

**Record of the inclusion of trains in an agreement
Route between RU 1 – RU 2 – RU 3 – RU 4 and back, 2007**

Train	Train run

Average number of wagons	
Days of operation per week	

RU carrying out the technical inspection	
Place where technical inspection is carried out	

Scheduled number of inspections (3 months)	
Scheduled number of inspections per month	

RU carrying out the quality inspection	
--	--

Max. acceptance value for Class 4 over 3 months	
Max. acceptance value for Class 5 over 3 months	

Number	January	February	March	April	May	June	July	August	September	October	November	December
Actual number of wagons inspected												
Class 4												
Class 5												
Comments												

Inclusion of the train in the agreement approved by

RU 1
Date, signature

RU 2
Date, signature

RU 3
Date, signature

RU 4
Date, signature

Record of the inclusion of trains in an agreement

Code, class of irregularity, number, short description							
Code in accordance with GCU Appendix 9	Class of irregularity	Number	Short description				

APPENDIX 9, ANNEX 4

Verification of qR

Measured at the wheel flange using a gauge, qR must always be greater than 6.5 mm, with no sharp edges or burrs on the outer part of the flange over a distance of 2 mm from the top of the flange.

Fig. 1 - Permissible profile for outer part of flange

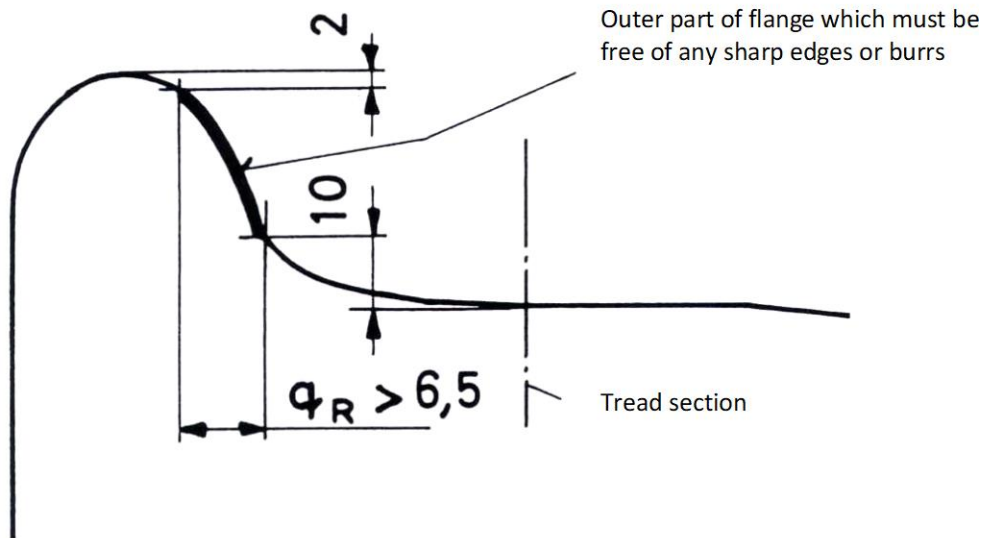

Fig. 2 - Gauge for verifying qR

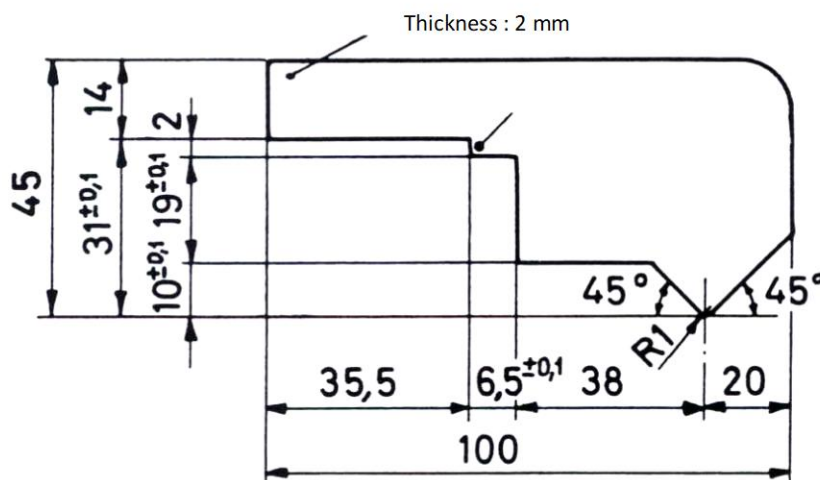

Fig. 3

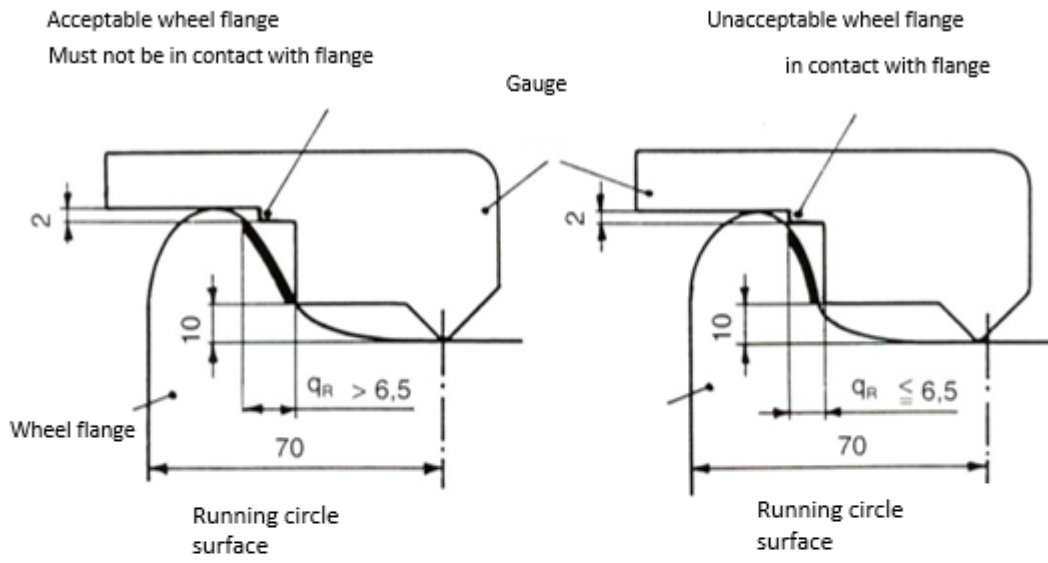
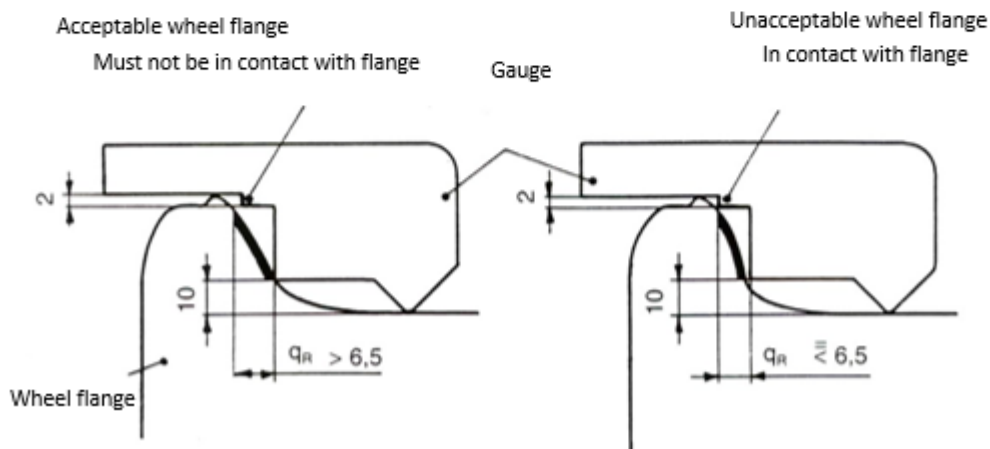

Fig. 4

Wheel flange with sharp edges or burr formation



APPENDIX 9, ANNEX 5

Catalogue of inspections in accordance with Annex 1

Code no.	Wagon	Component	Quality requirement	Control criteria ¹	Irregularity class
1.1.1	All wagons	Thickness of tyre	Compliance with dimensions set	VC, M	4
1.1.2		Tyre	Neither broken nor cracked	VC, HT	5
1.1.3		Tyre	Tight, not turned, clear ring, rust $\leq 1/3$ of circumference	VC, HT	5
1.1.4		Tyred wheel	Control marks present	VC	4
1.1.5		Tyre	Tight, not displaced laterally	VC, HT	5
1.1.6		Tyre clip	Present, not cracked, not broken	VC	5
1.2.1	All wagons	Tyre (solid wheel)	Groove marking minimum thickness fully visible in cross- section	VC	4
1.2.2.1		Tyre (solid wheel), except wheels marked as able to withstand high thermal stresses	No thermal overload due to braking, tolerance range not exceeded	VC, M	4
1.2.2.2.		Tyre (solid wheel), except wheels marked as able to withstand high thermal stresses	No thermal overload due to braking, tolerance range not exceeded	VC, M	5
1.3.1.1	All wagons	Tyre: width B > 139 mm and ≤ 140 mm	Compliance with stipulated tyre width	VC, M	3
1.3.1.2		Tyre: width B > 140 mm, < 133 mm Presence of a protrusion S	Compliance with stipulated tyre width	VC, M	4
1.3.2		Wheel tread	No crushing of wheel tread, no uneven contact surfaces or irregular burrs on the wheel rim	VC	4
1.3.3.1		Wheel tread	Wheel $\varnothing > 840$ mm, no wheel flat > 60 mm long	VC, M	4
1.3.3.2		Wheel tread	Wheel \varnothing : 630 mm < d ≤ 840 mm, no wheel flat > 40 mm long	VC, M	4
1.3.3.3		Wheel tread	Wheel $\varnothing \leq 630$ mm, no wheel flat > 35 mm long	VC, M	4
1.3.4.1		Wheel tread	Wheel $\varnothing > 840$ mm, no build-up of metal > 60 mm long or > 1mm thick	VC, M	4
1.3.4.2		Wheel tread	Wheel $\varnothing > 840$ mm, no build-up of metal > 10 mm ≤ 60 mm long and < 1mm thick	VC, M	3
1.3.4.3		Wheel tread	Wheel \varnothing : 630 mm < d ≤ 840 mm, no build-up of metal > 40 mm long or ≥ 1 mm thick	VC, M	4
1.3.4.4		Wheel tread	Wheel \varnothing : 630 mm < d ≤ 840 mm, no build-up of metal > 10 mm long and < 1mm thick	VC, M	3
1.3.4.5		Wheel tread	Wheel $\varnothing \leq 630$ mm, no build-up of metal > 35 mm long or ≥ 1 mm thick	VC, M	4
1.3.4.6		Wheel tread	Wheel $\varnothing \leq 630$ mm, no build-up of metal > 10 mm ≤ 35 mm long and < 1mm thick	VC, M	3

¹ VC = visual check; M = measurement; HT = hammer test; OP = operate; PM = pull or move the components

Code no.	Wagon	Component	Quality requirement	Control criteria ¹	Irregularity class
1.3.5.1		Wheel tread	Wheel $\varnothing > 840$ mm, no cavity, shelling or flaking > 60 mm long	VC, M	4
1.3.5.2		Wheel tread	Wheel \varnothing : $630 \text{ mm} < d \leq 840\text{mm}$, no cavity, shelling or flaking > 40 mm long	VC, M	4
1.3.5.3		Wheel tread	Wheel \varnothing : ≤ 630 mm, no cavity, shelling or flaking > 35 mm long	VC, M	4
1.3.6.1		Wheel tread	No cracks at the interface between the wheel tread and the front edge	VC	5
1.3.6.2		Wheelset front face, rim and inner tyre rim	No sharp-angled notches on the front face (rim or inner tyre rim) except for markings applied by the manufacturer	VC	4
1.3.6.3		Wheel tread	No damage, no notches	VC	4
1.3.6.4		Wheel tread	No damage, no notches	VC	5
1.3.7		Wheelset front faces	No lubricants or paint, except the 4 control marks	VC	5
1.3.8.1		Wheel tread	No damage	VC	4
1.3.8.2		Wheel tread	No damage, no grooves with sharp edges ≥ 1 mm deep	VC	5
1.3.8.3		Wheel tread	No damage, no furrows and false flanges > 2 mm deep	VC, M	5
1.4.1	All wagons	Flange	Compliance with height Sh	VC, M	4
1.4.2		Flange	Compliance with flange thickness, no worn flange	VC, M	5
1.4.3		Flange	Dimension qR adhered to, no sharp flange	VC, M	5
1.4.4		Flange	No burrs or sharp edges on guide face at a distance $h > 2$ mm from highest point of flange	VC, M	5
1.5.1	All wagons	Wheel centre	Not cracked, no defects repaired by welding	VC	5
1.5.2		Wheel centre	No break or crack in wheel centre, tyre clip, tyre, no defects repaired by welding	VC	5
1.6.1	All wagons	Axle	No damage; no grooving > 1 mm deep, no sharp edges	VC,	5
1.6.2	All wagons	Axle	No damage	VC	4
1.6.3	All wagons	Axle	No part rubbing against axle Check also 1.6.1 and 1.6.2	VC	4
1.7.1	All wagons	Wheel	No lateral displacement on axle; compliant value of "E"	VC, M	5

¹ VC = visual check; M = measurement; HT = hammer test; OP = operate; PM = pull or move the components

Code no.	Wagon	Component	Quality requirement	Control criteria ¹	Irregularity class
1.7.2		Wheel or immediate vicinity	No more than one of the following criteria on or near a wheel:	VC	4
			Brake triangle pin sheared off		
			Brake safety stirrup broken (see also 3.1.2)		
			Shiny traces on brake triangle end washer		
			Shiny traces on the inner spring (load spring) (see also 2.5)		
			Lifting safety catch (T) missing or loose (see also 2.5.5)		
			On Y25 bogies: hard manganese wear plate on axle boxes or guides missing or welded joints loose (see also 4.4.2)		
			See also 1.3.2		
1.8.1.1	All wagons	Axle box housing	Watertight housing	VC	4
1.8.1.2			No grease or all discharge on the wheel centre	VC	4
1.8.1.3			No trace of grease or all on the housing at the level of the cover	VC	4
1.8.2		Axle box housing	Not twisted, undamaged, guidance assured	VC	5
1.8.3.1		Axle box	No hot boxes	VC, check by hand	5
1.8.3.2		Axle box	No overheating during transport	VC	5
1.8.4	All wagons with Y bogie or derivative designs	Hard manganese wear plate	Secured, present	VC	4
2.1.1	All wagons	Spring leaves	Displacement < 10 mm with respect to the buckle	VC, M	4
2.1.2		Spring leaves	Main leaf not broken nor visibly cracked	VC	5
2.1.3		Spring leaves	No missing part	VC	4
2.1.4.1		Spring leaves	No crack on any other leaf < 1/4 of length of leaf from buckle centre	VC, M	4
2.1.4.2		Spring leaves	Intact	VC, M	3
2.1.5		Leaf spring	Sufficient spring clearance ≥ 15 mm; no recent traces of contact	VC, M	5
2.1.6		Buckle (leaf spring)	Intact, tight; key present and effective	VC	5

¹ VC = visual check; M = measurement; HT = hammer test; OP = operate; PM = pull or move the components

Code no.	Wagon	Component	Quality requirement	Control criteria ¹	Irregularity class
2.2.1.1	All wagons	Parabolic spring	No visible fracture or crack	VC	5
2.2.1.2		Parabolic spring	No breakage in buckle (no leaves touching for over 50% of their length)	VC	5
2.2.2.1		Parabolic spring	No longitudinal slippage of leaves in excess of 10 mm	VC, M	4
2.2.2.2		Parabolic spring	No longitudinal displacement of leaves	VC	3
2.2.3		Buckle (parabolic spring)	Intact, tight; key effective	VC	5
2.3.1	All wagons	Helical spring	Unbroken	VC	5
2.4.1	All wagons	Buckle boss	In position in its housing	VC	5
2.4.2		Shackle, link	Present and not displaced, damaged or out of position	VC	5
2.4.3		Link pin	Present and secured, not displaced	VC	5
2.4.4		Suspension links	Neither worn nor too long	VC	4
2.5.1	All wagons	Helical spring: main spring, tare spring	Not broken	VC	5
2.5.2.1	Empty wagons	Helical spring: auxiliary spring, load spring	In position, unbroken	VC	3
2.5.2.2	Loaded wagons	Helical spring: auxiliary spring, load spring	In position, unbroken	VC	5
2.5.3.1	All wagons	Damper rings per bogie	No rings missing, broken, damaged or unfit for use	VC	3
2.5.3.2		Damper rings per bogie	No more than one ring missing, broken, damaged or unfit for use	VC	5
2.5.4.1	All wagons	One spring cap per bogie	No cap exhibiting signs of contact or actually in contact with bogie frame	VC	3
2.5.4.2		Spring cap	Not more than one cap exhibiting signs of contact or actually in contact with bogie frame	VC	5
2.5.5	All wagons	Lifting T (safety catch)	Present and secured	VC	3
2.5.6		Suspension	No recent signs of bottoming	VC	5
3.1.1	All wagons	Brake rigging	No part hanging loose or damaged. Check also 1.6.1, 1.6.2 and 1.6.3	VC	4
3.1.2		Safety strap	Present, in proper condition	VC	4
3.1.3.1		Brake isolating cock	Operable	OP	3
3.1.3.2		Brake isolating cock	Position clear	VC, OP	3
3.1.4		Empty/loaded or G/P changeover device	Operable	OP	3
3.1.5		Brake release pull	Present and unbroken	VC	3

¹ VC = visual check; M = measurement; HT = hammer test; OP = operate; PM = pull or move the components

Code no.	Wagon	Component	Quality requirement	Control criteria ¹	Irregularity class
3.2.1	All wagons	Cast-iron brake block	Present, unbroken; thickness above the required minimum	VC, M	3
3.2.2		Composite brake block	Present, no radial crack from friction surface through to plate edge, no visible crumbling of more than one quarter of the block length. Thickness above the required minimum. No detachment of friction material from the back plate in excess of 25 mm and no cracking in excess of 25 mm in the direction of the wheel circumference.	VC, M	3
3.2.3		Friction components	Not projecting laterally	VC	4
3.2.4.1	All wagons	Inspection groove on the brake discs	Inspection groove completely visible	VC	3
3.2.4.2		Brake disc fixing	Suitable brake disc fixing	VC	5
3.2.4.3		Brake disc	No cracks > l/2 as per diagram	VC	3
3.2.4.4		Brake disc	No cracks in cross-section	VC	5
3.2.4.5		Cooling bars	Undamaged, no cracks	VC	3
3.2.4.6		Circular cooling fins	Undamaged, no cracks	VC	3
3.2.5		Brake linings	Present, not cracked	VC	3
3.2.6		Brake indicator	Suitable indication	VC	4
3.3.1.1	All wagons	Main brake pipe	Operable	VC	4
3.3.2.1	All wagons	Brake couplings	Present, intact	VC	3
3.3.2.2	All wagons	Brake couplings	Only one coupler plugged in, with the other secured in holder	VC	3
3.3.3	All wagons	Coupler holder	Present, operable	VC	3
3.3.4		Air brakes	Isolated brakes labelled accordingly	VC	3
3.3.5.1		Stopcock	Operable, airtight, not forced, handle present	VC, OP	5
3.3.5.2		Stopcock, stopping device	Present and obviously in good condition	VC	4
3.3.6.1		DET	Operational, switched on	VC	3
3.3.6.2		DET	Airtight	VC	3
3.3.6.3		DET	Detector's connection hose airtight	VC	4
3.4.1	All wagons	Spark arrestor plate	Present and not holed by rust	VC	4
3.4.2		Spark arrestor plate	Properly attached	VC	4

¹ VC = visual check; M = measurement; HT = hammer test; OP = operate; PM = pull or move the components

Code no.	Wagon	Component	Quality requirement	Control criteria ¹	Irregularity class
3.4.3	For the transport of dangerous goods in non- bogie wagons where RID regulations call for use of spark arrestor plates	Spark arrestor plate	Wagon must bear conventional symbol shown in Appendix 11 to the GCU, point 2.10 (spark arrestor plate authorised).	VC	5
3.5.1	All wagons fitted	Hand brake	Visibly operable	VC	3
4.1.1	All wagons	Underframe	No visible distortion; not buckled	VC	5
4.1.2		Solebar, headstock and intermediate crossbar	Not broken, cracks < 1/2 width of flange, longitudinal cracks < 100 mm near the suspension brackets, elsewhere < 150 mm; no cracking at visible welds	VC, M	4
4.2.1	All wagons	Axle guard	No distortion constituting a safety hazard	VC	5
4.2.2		Axle guard	Not broken	VC	5
4.2.3.1		Axle guard	Fastening effective, not loose	VC	5
4.2.3.2		Axle guard	No loose rivets or bolts on fastening	VC	3
4.2.4.1		Axle guard	No cracks extending more than ¼ of horizontal section	VC, M	4
4.2.4.2		Axle guard	No cracks	VC	3
4.2.4.2		Axle guard	No cracks	VC	3
4.2.4.3		Axle guard	No cracks close to or running towards a fastening point	VC	5
4.3.1	All wagons	Axle guard tie bar	Present, neither broken nor visibly distorted	VC	4
4.4.1.1	All wagons	Check plate (bogie wagon)	No check plate missing per axle	VC	3
4.4.1.2		Check plate (bogie wagon)	Not more than one check plate missing per axle	VC	4
4.4.1.3		Check plate (non-bogie wagon)	Present	VC	5
4.4.2	All wagons with Y bogies	Hard manganese wear plates	Secured, present	VC	4
4.5.1	All wagons fitted	Suspension bracket	In good condition, correctly secured	VC	5

¹ VC = visual check; M = measurement; HT = hammer test; OP = operate; PM = pull or move the components

Code no.	Wagon	Component	Quality requirement	Control criteria ¹	Irregularity class
4.6.1.1	All wagons	Bogie/underframe connection	Intact, not displaced; connection and fastening components present and effective	VC	5
4.6.1.2	All wagons	Bogie/underframe connection (bogie pivot kingpin)	Complete and effective	VC	4
4.6.2.1		Earthing strap	All present, undamaged, tight	VC	3
4.6.2.2		Earthing strap	At least 1 present and effective	VC	3
4.7.1	All wagons	Bogie frame	Not cracked or visibly distorted	VC	4
4.7.2		Bogie frame	No broken components	VC	5
4.7.3.1	All wagons with Y bogies	Bogie/frame connection	No missing or broken screws on inner longitudinal beam fastenings	VC	3
4.7.3.2	All wagons with Y bogies	Bogie/frame connection	No more than one missing or broken screw on inner longitudinal beam fastenings on the same axle	VC	5
4.8.1.1	All wagons	Side bearer	Not broken (no missing part)	VC	4
4.8.1.2		Side bearer	Not broken (missing part)	VC	5
4.8.2		Side bearer spring	No broken	VC	4
4.8.3		Side bearer fastening	Complete and effective	VC	3
4.9.1	All wagons	Friction surface of damper system	Not lubricated	VC	4
5.1.1	All wagons	Buffer types at each end of the wagon	Obviously of the same type	VC	4
5.1.2		Buffer height	Within tolerance range	VC, M	5
5.2.1	All wagons	Buffer head	Present, not broken, distorted but functional; rectangular buffer heads not twisted	VC	5
5.2.2.1		Buffer head	Fewer than 1/3 of bolts or rivets loose	VC	4
5.2.2.2		Buffer head	No loose bolts or rivets	VC	3
5.2.3.1		Buffer head contact surface	Lubricated if the two buffer heads which are in contact are made of metal	VC	5
5.2.3.2		Buffer head contact surface	No grooving	VC, M	5
5.2.4.1		Buffer head insert or plastic plate	Present, not broken, not cracked	VC	5
5.2.4.2		Buffer head insert or plastic plate	No crumbling/melding	VC, M	4
5.2.4.3		Buffer head insert or plastic plate	Fastening complete	VC	5
5.3.1	All wagons	Plunger	Present, not broken	VC	5
5.3.2.		Plunger	Not cracked at the transition to buffer head	VC	5
5.3.3.1		Plunger	No longitudinal cracking; still capable of guiding buffer	VC	5
5.3.3.2		Plunger	Operation not jeopardized, no grooving	VC, M	5

¹ VC = visual check; M = measurement; HT = hammer test; OP = operate; PM = pull or move the components

Code no.	Wagon	Component	Quality requirement	Control criteria ¹	Irregularity class
5.4.1	All wagons	Buffer guide	Present, not broken	VC	5
5.4.2		Buffer guide	Not cracked at transition to buffer base	VC	5
5.4.3.1		Buffer guide	No longitudinal cracking; still capable of guiding plunger	VC	5
5.4.3.2		Buffer guide	Operation not jeopardized, no grooving	VC, M	5
5.4.4.1		Buffer guide securing bolts	Tight (less than 2 bolts loose)	VC, PM	5
5.4.4.2		Buffer guide securing bolts	All bolts present	VC, PM	3
5.4.4.3		Buffer guide securing bolts	Tight (no bolts loose)	VC, PM	3
5.5.1	All wagons	Buffer spring	Functional, with compliant dimensions, unbroken. No buffers slack enough to be depressed by hand by more than 15 mm or neither of the two buffers able to be depressed.	VC, M	4
5.5.2	Marked wagons	Anti-crash components	Not triggered	VC	5
5.5.3	Marked wagons	Marking for anti-crash components	Present in its entirety, visible	VC	4
5.6.1.1	All wagons	Screw coupler	Present in its entirety and undamaged	VC	3
5.6.1.2	All wagons	Screw coupler	Fit for use and lubricated	VC	3
5.6.2		Hook for hanging coupler on when not in use	Present, fit for use, undamaged	VC	3
5.6.3		Looped coupling link	Hanging from hook	VC	3
5.7.1.1	All wagons	Draw hook	Serviceable, not broken or cracked	VC	3
5.7.1.2		Draw hook	Not twisted	VC	3
5.8.1	All wagons	Other draw gear parts	Present, not broken or cracked, no abnormal projection	VC	4
5.8.2		Coupling	Train correctly coupled	VC	4
5.9.1	All wagons	Long-stroke damper	Effective, sliding element in central position, undamaged	VC	4
5.9.2		Marking of danger points	Present	VC	4
6.1.1.1		Wagon number	Present, legible, complete	VC	4
6.1.1.2	Wagons with exchange codes beginning with a digit from 0 to 3	"RIV" sign, "TEN" + "GE" or acceptance marking ("TEN" + "G1", country acronym in approval plate)	Present, legible	VC	4

¹ VC = visual check; M = measurement; HT = hammer test; OP = operate; PM = pull or move the components

Code no.	Wagon	Component	Quality requirement	Control criteria ¹	Irregularity class
6.1.1.3	Wagons with exchange codes 41, 43, 45, 81, 83 or 85	Agreement plate or an acceptance marking ("TEN- CW", country code in approval plate)	Present, legible, complete	VC	4
6.1.1.4	All wagons	Tare	Present, legible, complete	VC	4
6.1.1.5		Holding force of parking brake	Present, legible, complete	VC	4
6.1.1.6		Load limits	Present, legible, complete	VC	4
6.1.1.7	Tank wagons	Capacity	Present, legible, complete	VC	4
6.1.1.8	All wagons	VKM or full address of the keeper	Present, legible, complete	VC	4
6.1.1.9	All wagons	Length-over-buffers	Present, legible, complete	VC	4
6.1.1.10	Wagons with ladders	High-voltage warning sign	Present, visible	VC	4
6.1.1.11	Container wagon	Specific marking	Present, visible	VC	4
6.1.2.1	All wagons	Inscription on the maintenance plate	Present, visible, complete	VC	4
6.1.2.2		Overhaul period (when appropriate+ "3 M" if marked)	Not expired, correctly labelled in accordance with Annex 8	VC	3
6.1.2.3		Overhaul period ≤ 6 months + "3 M"	Not expired, correctly labelled in accordance with Annex 8	VC	4
6.1.2.4		Overhaul period > 6 months + "3 M"	Not expired, correctly labelled in accordance with Annex 8	VC	4
6.1.3.1	All relevant wagons	Body framework	No damage	VC	3
6.1.3.2		Body framework	No damage which might compromise safety	VC, M	5
6.1.4.1	All relevant wagons	Walls	Secure, in good condition	VC	3
6.1.4.2		Walls	No damage which might cause goods to become damp or be lost	VC	4
6.1.5.1	All relevant wagons	Floor	Secure, watertight	VC	3
6.1.5.2		Floor	Secure, watertight, no risk of loss of load	VC	4
6.1.6.1	All relevant wagons	Doors and sliding walls	Fully closed and locked	VC	5
6.1.6.2		Doors and sliding walls	Present, not derailed, gauge not fouled	VC, M	5
6.1.6.3		Doors and sliding walls	Guiding and locking elements in good condition	VC	3

¹ VC = visual check; M = measurement; HT = hammer test; OP = operate; PM = pull or move the components

Code no.	Wagon	Component	Quality requirement	Control criteria ¹	Irregularity class
6.1.6.4		Doors and sliding walls	Guiding and locking elements in good condition and not compromising safety or causing a loss of load	VC	5
6.1.6.5	E, Ea	Doors	Undamaged	VC	3
6.1.6.6		Doors	No damage compromising operating safety	VC	5
6.1.7.1	All wagons	Ladders, gangways, guard rails	Operational	VC	4
6.1.7.2		Steps	Present (where clearly necessary)	VC	4
6.1.7.3		Steps	No damage representing a safety hazard for staff, not torn off, deformation within tolerated limits	VC, M	4
6.1.7.4		Handles	Present, no damage representing a safety hazard for staff, not torn off, deformation within tolerated limits	VC, M	4
6.1.7.5		Inscription plates, folding plates and label holders	Secured	VC	4
6.1.7.6		Inscription plates, folding plates and label holders	Present	VC	3
6.1.7.7		Loose wagon components	Present as marked on wagon	VC	3
6.1.7.8		Loose wagon components	Secured	VC	4
6.1.7.9		Signal brackets, rope eyes	Present, operable	VC	3
6.1.8.1	Covered wagons	Interior fittings	Undamaged, operable	VC	3
6.1.8.2	Covered wagons	Interior fittings	Undamaged, operable. If damaged unable to be repaired	VC	5
6.2.1.1	Covered wagons	Ventilation flaps	Present, undamaged	VC	3
6.2.1.2		Ventilation flaps	No damage compromising safety / load integrity or causing the gauge to be fouled	VC, M	5
6.2.2.1		Control gear, shutter retaining bracket	Securely hooked, not distorted, not loose	VC	3
6.2.2.2		Control gear, shutter retaining bracket	Not fouling the gauge	VC, M	5
6.2.3		Roof	Undamaged, watertight	VC	4
		Weatherboard	Present, undamaged, not loose	VC	4
6.2.4.1		Convertible roof	Secured and closed	VC	5
6.2.4.2		Convertible roof	Not derailed	VC	5
6.2.4.3		Visible operating parts	Present, undamaged, effective	VC	4

¹ VC = visual check; M = measurement; HT = hammer test; OP = operate; PM = pull or move the components

Code no.	Wagon	Component	Quality requirement	Control criteria ¹	Irregularity class
6.3.1.1	Open wagons	Side walls and end flaps	Undamaged, closed, watertight	VC	3
6.3.1.2		Side walls and end flaps	Undamaged, watertight and closed. If damaged: no risk of loss of load	VC	4
6.3.1.3		Side walls and end flaps	Undamaged, watertight and closed. If damaged: no risk of fouling gauge	VC	5
6.3.2.1	All wagons	Closing and operating gear of end flaps (pin, camshaft, retaining hook and shaft support)	Present, no fractures or cracks, effective	VC	3
6.3.2.2		Closing and operating gear of end flaps (pin, camshaft, retaining hook and shaft support)	Present, no fractures or cracks, effective If damaged/missing: not compromising safety	VC	5
6.3.3.1		Cantrail	Not damaged or distorted	VC	3
6.3.3.2		Cantrail	Not damaged or distorted. If broken or distorted: no risk of fouling gauge	VC	5
6.4.1.1	Flat wagons	Side and end drop walls, folded down	Secured	VC	5
6.4.1.2		Side and end drop walls, folded down (not permitted under Table 3 of the Loading Guidelines)	Raised	VC	5
6.4.1.3		Side and end drop walls	Not distorted	VC, M	3
6.4.1.4		Side and end drop walls	Not damaged or distorted. If damaged or distorted: no risk of loss of load	VC	4
6.4.1.5		Side and end drop walls	Not distorted. If distorted: no risk of fouling gauge	VC	5
6.4.2.1		Hinges, pins, securing bolts	Present, undamaged, operative	VC	3
6.4.2.2		Hinges, pins, securing bolts	Present, undamaged, operative. If missing or damaged: without compromising safety or risking any loss of load	VC	4
6.4.3.1		Stanchions (pivoting, retractable, detachable), stanchion sockets, holders and supports	Provided as necessary	VC	5

¹ VC = visual check; M = measurement; HT = hammer test; OP = operate; PM = pull or move the components

Code no.	Wagon	Component	Quality requirement	Control criteria ¹	Irregularity class
6.4.3.2		Stanchion (pivoting, retractable, detachable), stanchion sockets, holders and supports	Not fouling the gauge	VC	5
6.4.3.3		Stanchion (pivoting, retractable, detachable), stanchion sockets, holders and supports	Intact	VC	4
6.4.3.4		Stanchion chain	Hooked up	VC	4
6.4.3.5		Stanchion fasteners	Effective	VC	4
6.4.4.1		Bolsters	Intact	VC	3
6.4.4.2		Bolsters	Secured by stanchions or load	VC	4
6.5.1.1	Tank wagons	Tank cradle	No crack extending > 1/4 across the cross-section	VC, M	4
6.5.1.2		Tank cradle	No cracks in weld seams	VC	4
6.5.1.3		Tank cradle	All bolts or rivets securing the tank body to cradle present	VC	4
6.5.1.4		Tank cradle	90% of bolts or rivets securing the tank body to cradle present	VC	4
6.5.2.1		Tank body	Intact, no leaks or loss of load	VC	5
6.5.2.2		Tank body	No sharp-edged distortion (without loss of load)	VC	4
6.5.2.3		Tank full, RID load	Tank test deadline not expired, no "L" marking	VC	4
6.5.2.4		Tank full, RID load	Tank test deadline not expired, no "L" marking	VC	5
6.5.2.5		Tank empty, not cleaned, RID load	Tank test deadline not expired, no "L" marking	VC	4
6.5.2.6		Tank full, RID load	Tank test deadline not expired, "L" marking	VC	5
6.5.2.7		Tank empty, not cleaned, RID load	Tank test deadline not expired, "L" marking	VC	4
6.5.3.1		Tank equipment	Tank cladding, sunroof and insulation undamaged	VC	4
6.5.3.2		Tank equipment	Tank cladding, sunroof and insulation securely fastened	VC	5
6.5.5.1	Tank wagons	Reinforcement, filling and emptying equipment (underside)	No leakage of load	VC	5
6.5.5.3		Valves or spouts (underside)	Undamaged	VC	4

¹ VC = visual check; M = measurement; HT = hammer test; OP = operate; PM = pull or move the components

Code no.	Wagon	Component	Quality requirement	Control criteria ¹	Irregularity class
6.5.5.1	Tank wagons	Reinforcement, filling and emptying equipment (underside)	No leakage of load	VC	5
6.5.5.3		Valves or spouts (underside)	Undamaged	VC	4
6.5.5.4		Lower screw cap (except outside gas pipes), RID load	Present and in use, tightly closed	VC	4
6.5.5.5		Lower screw cap (except outside gas pipes), non-RID load	Present and in use, tightly closed	VC	3
6.5.5.6		Lower blind flange	Present	VC	4
6.5.5.7		Lower blind flange, RID load	No securing bolt missing or loose	VC, PM	4
6.5.5.8		Lower blind flange, non-RID load	No securing bolt missing or loose	VC, PM	3
6.5.5.9		Lower blind flange	Not more than one securing bolt missing or loose	VC, PM	4
6.5.5.10		Bottom valve indicator device, loaded wagon, and empty wagons that have not been cleaned (RID load)	In closed position	VC	5
6.5.5.11		Bottom valve indicator device, empty wagon (non- RID load)	In closed position	VC	3
6.5.5.12		Emergency control bolt for the bottom valve	Not screwed in the valve body	VC	5
6.5.5.13		Lower filling and emptying equipment	In closed position	VC	5
6.5.5.14		Lower filling and emptying equipment	Visible locking devices effective	VC	4
6.5.6.1	Tank wagons	Reinforcement, filling and emptying equipment (topside)	No loss of load or gas leakage (except ventilation device)	VC	5
6.5.6.2		Dome cover	Present, closed, visibly locked	VC	5
6.5.6.3		Other upper closing devices	Properly locked	VC	4
6.6.1.1	e.g. Rils, Tams	Sheeting	Closed, locked	VC	5
6.6.1.2		torn, holed sheeting ≤ 30 mm	Undamaged	VC, M	3
6.6.1.3		torn, holed sheeting > 30 mm	Undamaged	VC, M	5
6.6.2.1	e.g. S(a)hi	Hood	Closed, locked	VC	5
6.6.2.2	e.g. S(a)hi	Hood	Not derailed	VC, PM	5
6.6.3.1	e.g. Saad	End gangway	Undamaged	VC	4
6.6.3.2	e.g. Saad	End gangway	Locked at both ends	VC	5

Code no.	Wagon	Component	Quality requirement	Control criteria ¹	Irregularity class
6.6.3.3		Fastening devices	Effective	VC	4
6.6.3.4		Wheel scotches	Undamaged	VC	3
6.6.4.1	ACTS wagons	Swivel frame	Undamaged	VC	4
6.6.4.2		Locking device to prevent frame from swiveling	Effective, locked	VC	5
6.6.4.3		Pneumatic monitoring system on the swivel lock	In service (unless labelled otherwise)	VC	4
6.6.4.4		Pneumatic monitoring system on the swivel lock has triggered	Swivel lock effective and locked	VC	3
6.6.4.5		Device to prevent container lifting	Effective and secured	VC	5
6.6.4.6		Device to prevent container displacement	Effective	VC	5
6.6.5.1	Car-carrying wagons	Lifting equipment, crossover gangways	Undamaged	VC	4
6.6.5.2		Wheel scotch, wheel guides, crank handle	Undamaged	VC	3
6.6.5.3		End boards, crossing gangways	Raised and secured – if necessary	VC	4
6.6.5.4		Upper loading deck	Indicating device folded away	VC	4
6.6.5.5		Upper loading deck	Secured	VC	5
6.6.5.6		Upper loading deck	Lying on supporting brackets	VC	5
6.6.5.7	Loaded car-carrying wagons	Upper loading deck	No fouling of the gauge	VC	5
6.6.5.8		Gangways above central axles	Fully maneuverable, distance between wheel and gangway > 100 mm	VC, M	5
6.6.5.9	Empty car-carrying wagons	Crossover plates on central axles	Neither distorted, broken, nor cracked. No missing parts	VC	4
6.6.5.10	Loaded car-carrying wagons	Crossover plates on central axles	Neither distorted, broken, nor cracked. No missing parts	VC	5

Code no.	Wagon	Component	Quality requirement	Control criteria ¹	Irregularity class
6.6.6.1	Empty self-discharging wagons	Axial flap	Closed and locked	VC	3
6.6.6.2	Loaded self-discharging wagons	Axial flap	Closed and locked	VC	4
6.6.6.3	Empty self-discharging wagons	Lateral flap	Closed and locked	VC	4
6.6.6.4	Loaded self-discharging wagons	Lateral flap	Closed and locked	VC	4
6.6.7.1	E.g. Snps, Roos, Ealos	Securing equipment not in use	Suitably and adequately fixed and secured	VC, OP	4
6.7.1.1	Container Wagons	Seating device not in use	Locked, intact	VC	3
6.7.1.2		Seating device in use	Locked, intact	VC	5
6.7.1.3		Spigot not in use	Intact	VC	3
6.7.1.4		Spigot in use	Triggered, intact	VC	5
6.7.2		Pivot of trailer coupling in the trestle	Locked	VC	5
6.7.3		Seating device not used	Locked	VC	3
6.7.4		Seating device wheel	Locked, with no risk of fouling the gauge	VC	5
6.7.5.1		Moving parts	Locked	VC	3
6.7.5.2		Moving parts	Fixed, with no risk of fouling the gauge	VC	5
6.7.6.1		Anti-crash system of seating device in use	Non-deformed	VC	5
6.7.6.2		Anti-crash system of seating device not in use	Non-deformed	VC	4

¹ VC = visual check; M = measurement; HT = hammer test; OP = operate; PM = pull or move the components

Code no.	Component	Quality requirement	Control criteria ¹	Irregularity class
7.1.1	Load	Not displaced	VC	5
7.1.2	Distribution of load (3.3)	Body horizontal, showing no signs of poor distribution	VC	5
7.1.3	Packages, bales, bundles, stacks (1.5)	Correctly stowed and tied together	VC	4
7.1.4	Narrow cylindrical objects (1.5)	Adequately tied	VC	4
7.1.5.1	Loading gauge (4.1)	Not fouled	VC, M	5
7.1.5.2	Loading gauge	Permissible fouling of gauge marked	VC	5
7.1.6	Load projecting beyond headstock (4.2)	No encroachment on reserved spaces	VC, M	5
7.1.7.1	Load limits (3.2), visual observation	Body showing no sign of overloading, buffers level, sufficient clearance between spring buckle and solebar	VC, M	5
7.1.7.2	Load limits (3.2), otherwise recorded	No discrepancy between consignment data and load limits. Measurement and diagnostics data are within tolerances	VC, M	5
7.1.8	Buffer wagon (4.3)	Sufficient clearances between loads or between buffer wagon and load	VC, M	5
7.1.9	Sheeting, net (6.1, 6.2)	Conditions of use adhered to	VC	4
7.1.10	Loss of load	Conditions of use adhered to. If damaged: without risk of loss of load	VC	5
7.2.1	Load projecting beyond walls or sides of wagon (5.4.1)	Adequately retained	VC	5
7.2.2	Leaning load (2.3)	Not causing damage to structural elements of wagon, or obstructing their functioning	VC	4
7.2.3.1	Load secured by stanchions (2.5 and 5.4.1)	Adequately retained	VC, M	5
7.2.3.2	Transverse lashing ropes between stanchions (2.5)	Present where required	VC	5
7.2.3.3	Load pressing against stanchions (2.5)	No distortion of stanchions	VC	5
7.2.3.4	Heavy load or one which may damage the side stanchions should it move lengthways (2.5)	Securely wedged, not touching stanchions	VC	4
7.2.4	Scotches fastened with nails (5.4.3)	Suitable, effective and correctly fixed to the floor	VC	5
7.2.5.1	Direct or indirect fastenings (5.4.4, 5.5.4)	Made from suitable and approved materials	VC	5
7.2.5.2		Sufficient and correctly fastened	VC	5
7.2.5.3		Not slack	VC	4

¹ VC = visual check; M = measurement; HT = hammer test; OP = operate; PM = pull or move the components

Code no.	Component	Quality requirement	Control criteria ¹	Irregularity class
7.2.6.1	Bolsters, timbers, stretchers stowing material (5.5.5, 5.6.2, 5.8.1)	Adapted to load and visibly well positioned and secure	VC	5
7.2.6.2	Loading tackle and stowing material	Tidied away	VC	3
7.2.7	Potentially hazardous residues	Residues removed	VC	5
7.2.6.1	Bolsters, timbers, stretchers stowing material (5.5.5, 5.6.2, 5.8.1)	Adapted to load and visibly well positioned and secure	VC	5
7.2.6.2	Loading tackle and stowing material	Tidied away	VC	3
7.2.7	Potentially hazardous residues	Residues removed	VC	5
7.3.1	Load stability (5.1)	Ensured	VC	5
7.3.2	Goods which may be lifted by air flow, e.g. light scrap and light boards (5.2.1, 5.3.2)	Sufficiently well covered	VC	5
7.3.3.1	Goods which may fall off (vibrations, impacts) (5.2.2)	Sufficient clearance between the goods and the top of the wagon sides	VC	5
7.3.3.2	Height of dome-shaped load	Compliant with dimensions	VC	5
7.3.4	Stacked goods (5.8)	Correctly stacked, adequately bound and secured, not too high, correctly dovetailed, evenly distributed, clearances adhered to	VC	5
7.3.5.1	Load with small bearing surface (2.2)	Base provided in order to distribute weight over a greater area without damaging floor	VC	3
7.3.5.2	Concentrated loads	Suitable scotching materials of the correct dimensions	VC, M	5
7.3.6	Load liable to tip over (5.7)	Secured to avoid overturning	VC	5
7.3.7	Inclined load (5.7)	Adequately propped up	VC	5
7.3.8	Load liable to roll (5.6.1, 5.6.2)	Secured to prevent rolling	VC	5
7.3.9.1	Load able to slide lengthways (5.5.1)	Resting on suitable devices (skid, longitudinal slide arresters, lateral guide-pieces, etc.)	VC	4
7.3.9.2	Lateral guidance	In place, sufficient and with no risk of fouling the gauge or exceeding the load limit	VC, M	5
7.3.9.3	Necessary clearances	Provided	VC, M	3
7.3.9.4	Necessary room to slide	Limited in accordance with requirements	VC, M	4
7.4.1	Vehicle or machinery on wheels or caterpillar tracks (5.6.3)	Properly scotched and fastened	VC	5
7.4.2.1	Moving parts on load	Secured	VC	3
7.4.2.2	Moving parts on load	Secured. If not secured, no risk of the gauge being fouled	VC	5
7.4.3	Load supported on several wagons (5.9)	Loaded and secured in accordance with requirements	VC	5

¹ VC = visual check; M = measurement; HT = hammer test; OP = operate; PM = pull or move the components

Code no.	Component	Quality requirement	Control criteria ¹	Irregularity class
7.5.1	Locking device for dollies	Auxiliary equipment, present and effective	VC	4
7.5.2.1	ILU end doors not closed	Closed (unless load unit doors back-to-back)	VC	5
7.5.2.2	ILU end doors not properly closed	Door completely closed (unless load unit doors back-to-back)	VC	4
7.5.3	Inferior wedge parts	Intact	VC	5
7.5.4	Side wall, damaged cover	Intact, locked	VC	5
7.5.5.1	Cracked sheet, holed ≤ 30 mm	Intact	VC, M	3
7.5.5.2	Cracked sheet, holed > 30 mm	Intact	VC, M	5
7.5.5.3	Load	No damage from humidity to the load or loss of load	VC	4
7.5.6	Lock for sheets, side wall	Effective	VC	5
7.5.7	Frame/load-bearing parts	Not cracked or broken	VC	5
7.6.1.1	Tank cradle	No crack > Crack > 1/4 of the section	VC, M	4
7.6.1.2	Tank cradle	No crack in the weld seams	VC	4
7.6.2.1	Tank body	Tight: no leak or loss of load	VC	5
7.6.2.2	Tank body	No distortion with sharp edges and risk of loss of load	VC	4
7.6.3.1	Tank equipment	Tank cladding, sunroof, insulation not damaged	VC	4
7.6.3.2	Tank equipment	tank cladding, sunroof, insulation not loose	VC	5
7.6.4.1	Reinforcement, filling and emptying equipment, underneath	No loss of load	VC	5
7.6.4.2	Valves or spouts, underneath	Not damaged	VC	4
7.6.4.3	Screw cap, underneath, RID load	Tightly sealed	VC	4
7.6.4.4	Screw cap, underneath, non-RID load	Tightly sealed	VC	3
7.6.4.5	Blind flange, underneath	No missing	VC	4
7.6.4.6	Blind flange, underneath, RID load	No securing bolt missing or loose	VC, PM	4
7.6.4.7	Blind flange, underneath, non-RID load	No securing bolt missing or loose	VC, PM	3
7.6.4.8	Blind flange, underneath, non-RID load	Not more than one securing bolt missing or loose	VC, PM	4

¹ VC = visual check; M = measurement; HT = hammer test; OP = operate; PM = pull or move the components

Code no.	Component	Quality requirement	Control criteria ¹	Irregularity class
7.6.4.9	Bottom valve indicator device, LU, and empty wagons that have not been cleaned (RID load)	In “closed” position	CV	5
7.6.4.10	Bottom valve indicator device, LU, empty (non-RID load)	In “closed” position	CV	3
7.6.4.11	Bottom valve emergency control device	Not screwed in	CV	5
7.6.4.12	Filling and emptying equipment, underneath	“Closed” body	CV	5
7.6.4.13	Filling and emptying equipment, underneath	Efficient visible locking devices	CV	4
7.6.5.1	Reinforcement, filling and emptying equipment, above	No loss of load or of gas (does not concern ventilation devices)	CV	5
7.6.5.2	Dome cover	Present, closed, visibly locked	CV	5
7.6.5.3	Other upper reinforcements	Properly locked	CV	4
7.7.1	Load unit on carrier wagon	Within load requirements for wagon	VC	5
7.7.2	Load unit on carrier wagon	All corner castings engaged on their respective spigots	VC	5
7.7.3	Lowerable pins	All pins engaged and locked	VC	5
7.7.4	Semi-trailer	Air suspension emptied	VC	5
7.7.5	Semi-trailer	Raiseable underrun bumpers in correct position according to compatibility code of the recess wagon and with no contact with the carrier wagon	VC	3
7.7.6	Semi-trailer	On semi-trailers with P coding: no contact between semi- trailer and wagon other than through wheels and trestle	VC	4
7.7.7	Semi-trailer	On semi-trailers with N coding: no contact between semi- trailer and wagon other than through wheels, skids and longitudinal members in the intended support areas	VC	4
7.7.8	Scotching of semi-trailer	Correct scotching	VC	4
7.7.9	Loading into load unit	No visible signs of distortion	VC	5
7.8.1	Markings, coding for combined traffic	At least one plate present and legible	VC	5
7.8.2	Wagon coding indicating permissible load units	Marking present on wagon	VC	5
7.8.3	Load unit (ILU) with upper corner castings	CSC safety plate present	VC	4
7.8.4	“high voltage” warning sign on ILU with ladder access	Present	VC	4

¹ VC = visual check; M = measurement; HT = hammer test; OP = operate; PM = pull or move the components

Code no.	Component	Quality requirement	Control criteria¹	Irregularity class
8.1.1	All wagons	No trace following derailment	VC	5
8.1.2	All wagons	No trace following abnormal shunting impact	VC	5
8.2.1	All wagons	No trace following flooding or damage due to poor weather	VC	5
8.2.2	All wagons	No trace of damage due to current start-up	VC	5
8.2.3	All wagons	No trace left by fire	VC	5

¹ VC = visual check; M = measurement; HT = hammer test; OP = operate; PM = pull or move the components

APPENDIX 9, ANNEX 6

Technical Transfer Inspection - List of irregularities noted on wagons and their loads

Station of transferee RU where the irregularity was detected: RU which carried out the technical transfer inspection:

Train number: Number of wagons inspected: Transferor RU:

Number of wagons damaged according to Annex 5:

Date	Wagon number (12 digits)	Description of irregularity	Code no. as per Annex 1 or 5	Class of irregularity	Label affixed by transferor railway?		Wagon loaded?		Gauge fouled as a result of irregularity?		Loaded wagon Loss of load possible?		Temporary repair or remedy effected by transferor railway in accordance with Annex 1			
					yes	no	yes	no	yes	no	yes	no	Necessary?		Performed?	
					6	7	8	9	10	11	12	13	14	15	16	17
1	2	3	4	5	6	7	8	9	10	11	12	13	14	15	16	17
					Σ Irregularities of class 3											
					Σ Irregularities of class 4											
					Σ Irregularities of class 5											

-reserved-

APPENDIX 9, ANNEX 7

Technical Transfer Inspection - Record and analysis of irregularities noted on wagon and loads

RU which carried out the quality inspection:

RU which carried out the technical transfer inspection:

Transferor RU:

Month/ year	Border station	Number of wagons inspected	Number of Class 3 to 5 irregularities						Comments	
			Class 3		Class 4		Class 5			
			Σ	Col 4 x 0.125	Σ	Col 6 x 0.40	Σ	Col 8 x 1.0		
1	2	3	4	5	6	7	8	9	10	

-reserved-

APPENDIX 9, ANNEX 8

Handling of wagons

1. With expired maintenance plate (or expired overhaul period)

Empty and loaded wagons with an expired maintenance plate (overhaul period exceeded) must be accepted.

Since wagons whose overhaul period is expired are no longer formally authorised to run, special measures must be taken at the time of expiry of the overhaul period to record and certify their fitness to run.

- 1.1 Until the expiry of the overhaul period, empty wagons and loaded wagons shall be treated in the same way. After expiry of this period, extended as appropriate by 3 months if the vehicle carries the “+3M” marking, a distinction shall be made between empty and loaded wagons. The details are given in the following diagram:

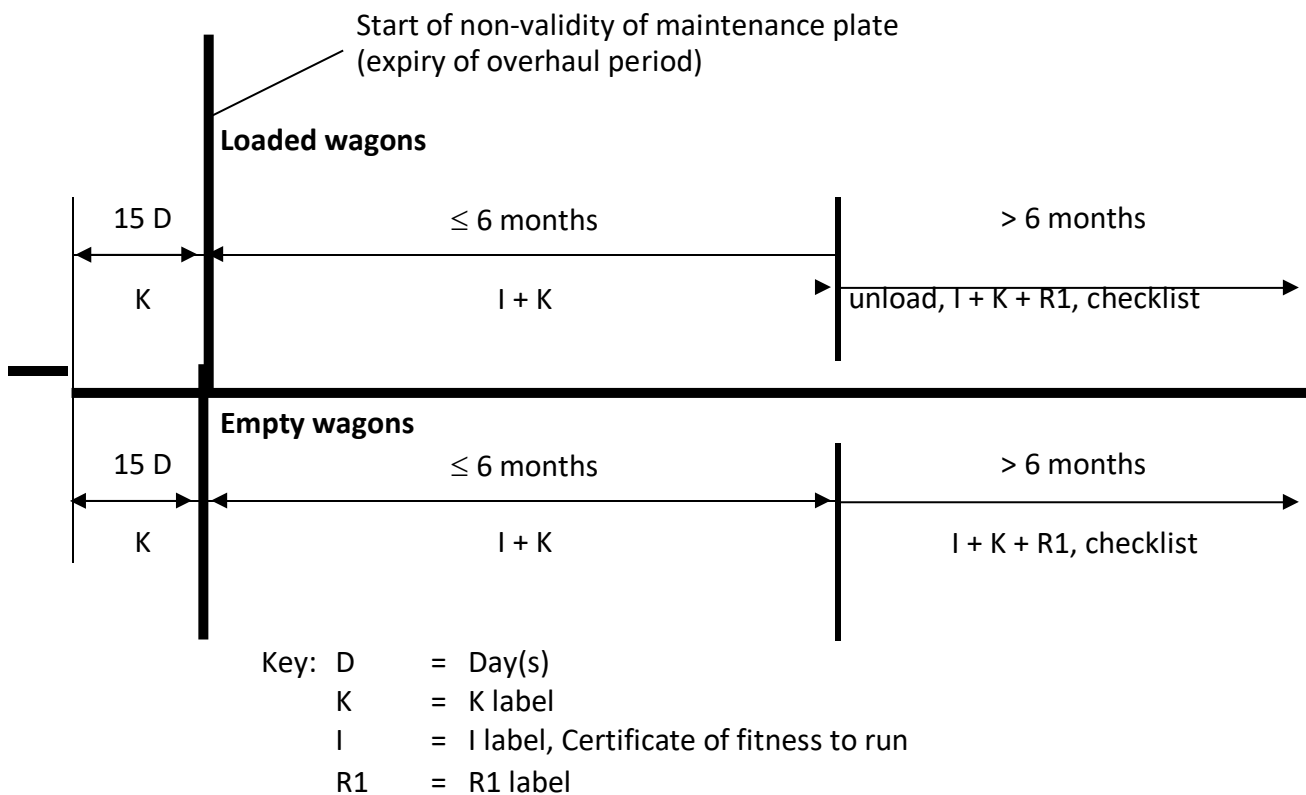

- 1.2 The issuing of an I label (certificate of fitness to run) is always based on an examination of fitness to run. For wagons whose overhaul period is exceeded by at least six months, this examination shall consist of a Technical Transfer Inspection as defined in section 2 (Appendix 9 to the GCU). If no damage or irregularity preventing the continued conveyance of the empty wagon without a speed limit is noted, the wagon should be labelled with K and I labels. These wagons, which are fit to run without restriction, shall be handled like damaged vehicles carrying labels and can therefore be included in or remain part of any scheduled train service.

Note concerning the procedure:

The initial examination by the qualified staff is crucial. This shall be carried out according to when the overall period expired (see diagram) and remains valid until the wagon arrives at the destination station or the workshop where the overhaul is to take place. In this case, qualified staff shall act in accordance with their own practical experience.

- 1.3 The wagons shall be removed from the train after reporting of damage or irregularities which have led to a speed restriction. Onward conveyance of these wagons is only authorised after repair or as special consignments (SC).
- 1.4 Empty and loaded wagons with an overhaul period that has been exceeded by over 6 months and under 5 years must be removed; loaded wagons must also be unloaded. Onward conveyance is only authorised once the examination of fitness to run has been conducted in accordance with the specific checklist (**Annex 9**).
- 1.5 The costs incurred are to be invoiced to the keeper in accordance with the GCU, article 22.4, first bullet point. The formal damage report described in Appendix 4 to the GCU is to be attached to the invoice as evidence. The costs shall include the cost of conducting the examination of fitness to run, the filling out and affixing of the I label and the cost of operation. If the overhaul period is exceeded, the invoice shall include all the resulting costs.

2. With exceeded load limit

Instructions on the procedure to follow for onward conveyance following identification of overloading and for taking the necessary corrective measures

In the event that the maximum load per wheel, wheelset or wagon has been identified as exceeded by means of technical measuring devices (train inspection devices) or on the evidence of visible signs on the wagon, or if other irregularities have been noted, the following procedure must be applied.

Once the wagon has been removed, the weight of the wagon, wheelset or wheel must be checked by means of scales should no data from the dynamic measurement systems in the infrastructure be available.

Wheelset overloading percentage:

On detection, a value “C” must be measured for the load, taking into account the accuracy of the means of measurement “p”. The overload percentage is calculated using the following formula:

$$\% \text{ overload} = 100 \times ((C(1-p^*)/\text{nominal load}) - 1)$$

* if the accuracy of the means of measurement is unknown, “p” = 0 is applied.

- If wheelset overload exceeds 2% and is less than or equal to 10%, the load must be rectified. A visual check shall be performed in accordance with the “overloading” checklist (Annex 9). The wagon shall be marked with the K label.
- If wheelset overload exceeds 10%, transshipment is required. Following a technical assessment, the wagon shall be marked with the K label in accordance with the “overloading” checklist (Annex 9) and conveyed empty to a workshop located nearby.

If the permissible wheelset load cannot be identified on the wheelset, the wagon must be conveyed to a workshop located nearby.

Wheelset markings

If wheelset overload is greater than 2%, the wheelset must be marked with a white cross on the axle.

Summary:

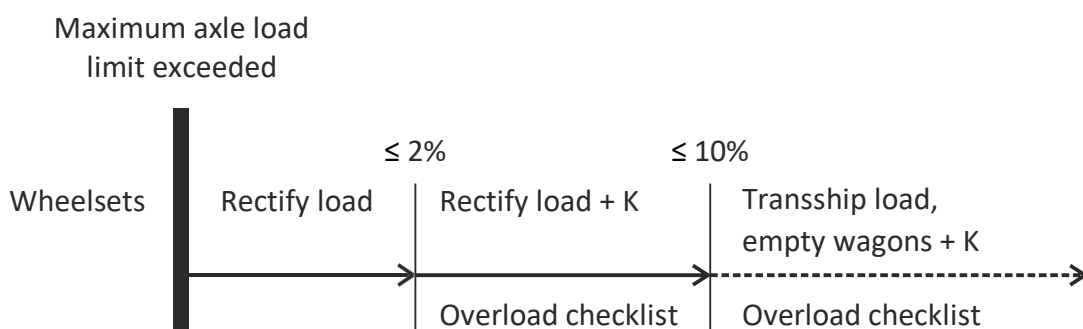

3. With exceeded concentrated load

Instructions on the procedure to follow for onward conveyance following identification of exceeded concentrated load and for taking the necessary corrective measures

- Visual assessment of wagon with exceeded concentrated load
- Calculation of load weight by means of scales or from information on the consignment note
- Calculation of exceeded concentrated load percentage compared to the inscriptions on the wagon in accordance with number 3.4 of the UIC Loading Guidelines, Volume 1

Exceeded concentrated load and procedure:

- If less than or equal to 5%, the overload is simply rectified.
- If greater than 5% and less than or equal to 20%, the overload must be rectified. A visual check shall be performed in accordance with the “exceeded concentrated load” checklist (Annex 9). The wagon shall be marked with the K label.
- If wheelset overload exceeds 20%, transshipment is required. Following a technical assessment, the wagon shall be marked with the K label in accordance with the “overloading” checklist (Annex 9) and conveyed empty to a workshop located nearby.

Summary:

Exceeded concentrated load

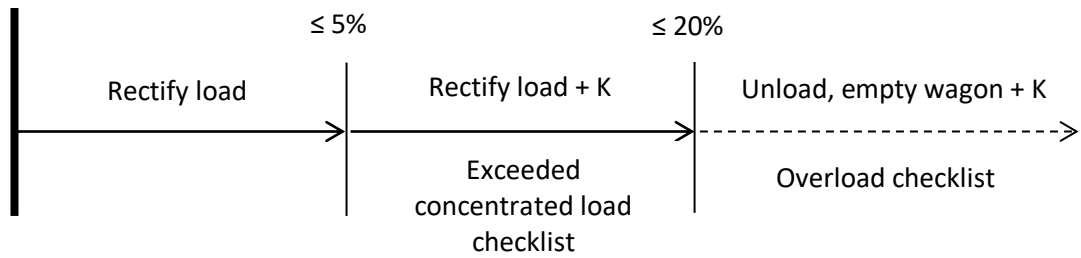
**4. With wheels displaying the criteria for thermal overload as per no. 1.2.2**

For wheels displaying indications of thermal overload as per no. 1.2.2 and not being marked as being able to withstand high thermal stresses,

- measure the widening of the inner faces (E value) at the running surface of the rail at 3 points, at distances of 120° , and verify no. 1.7.1.
- inspect the tread for isolated cracks in the cross-section
- Annex 12 (Traceability) must be completed.

5. Equipped with a DET (derailment detector)

- Tracing a tripped detector:

When a tripped detector is detected, the wagon (all axles) must be examined in accordance with the checklist (Annex 9) in order to determine the cause. If it has proved impossible to identify the cause, reset the display unit of the detector by pressing on the red flap of the trip indicator.

- DET not airtight (air leakage):

Isolate the detector using the handle and replace it as soon as possible.

- Yellow lever handle in a vertical position: detector tripped
- Yellow lever handle in a horizontal position: detector not tripped

Resetting:

The DET only resets itself automatically once the main brake pipe is fully drained; only then can the main brake pipe be refilled.

The trip indicator (red flap) remains visible at all times and must be reset manually once the pressure in the main brake pipe is zero.

After inspection of the wagon, the trip indicator may be reset.

APPENDIX 9, ANNEX 9

Checklists

These checklists must be followed in their entirety in addition to the criteria in Annex 1. Where applicable, reasons for unfitness to run must be indicated. The measured values must be documented for the purpose of traceability (Annex 12).

1. INSPECTION OF FITNESS TO RUN FOR WAGONS WITH AN EXPIRED MAINTENANCE PLATE

- **Reference:** Annex 8, point 1.4: empty wagon with a maintenance plate (overhaul period) that has been expired for at least 6 months and for a maximum of 5 years.
- **The measured values of the wheelsets must be documented for the purpose of traceability (Annex 12).**

1	2	3	4	5
Number	Question	Answer	Go to number	Comments
Provisions common to vehicles with individual axles and bogies				
1	Is the wagon marked with an interoperability sign conform to point 6.1.1.2 and 6.1.1.3 of Annex 1?	Yes No	2 12.2	
2	Is the loading gauge of the participating RUs respected?	Yes No	3 2.1	
2.1	Have the participating RUs agreed for the wagon to be handed over?	Yes No	3 12.2	
3	Do the wheelsets have an identification mark?	Yes No	3.1 12.2	Ask the keeper and wait for his written confirmation.
3.1	Does the keeper confirm that the overhaul date has not been exceeded?	Yes No	4 / 4.1 12.2	If not possible, 12.2
4	Does the wheel tyre thickness conform to the criteria of point 1.1.1 of Annex 1?	Yes No	5 12.2	Measure
4.1	Or Does the groove marking the minimum thickness for one-piece wheels conform to the criteria of point 1.2.1 of Annex 1?	Yes No	5 12.2	

Number	Question	Answer	Go to number	Comments
5	Are there signs of damage due to an incident, derailment, violent shunting impacts or thermal overload (with the exception of wheelsets marked as being able to withstand high thermal stresses)?	Yes No	5.1 5.2	
5.1	Do the values S_d , S_R , qR and E lie within the permissible limits and is there no sign that the wheels are misaligned with the axle?	Yes No	6 12.2	Measure (for the E value measure at 3 points)
5.2	Do the values S_d , S_R , qR and E lie within the permissible limits and is there no sign that the wheels are misaligned with the axle?	Yes No	6 12.2	Measure (for the E value measure at 1 point)
6	Does the distance between active surfaces (S_R) satisfy the following criteria: <ul style="list-style-type: none"> – no more than 1426 mm? – at least 1410 mm for a wheel diameter > 840 mm? – at least 1415 mm for a wheel diameter \leq 840 mm? 	Yes No	7 12.2	
7	Is the wagon clearly fitted with a uniform type of suspension springs?	Yes No	8 12.2	
8	Does the buffer height lie within the permissible tolerances?	Yes No	9 12.2	Measure
9	Does the wagon have superstructures liable to rotate, be displaced or otherwise move during the journey?	Yes No	10 11	
10	Are there sufficient devices outwardly visible for securing moving superstructures and are they present and effective?	Yes No	11 12.2	
11	Is the wagon otherwise free of safety-critical damage or defects?	Yes No	12.1 12.2	
	Results of the examination of fitness to run			Measures
12.1	The wagon may continue to run empty at the marked speed (with the brake isolated).			Fill out the Label I, indicate wagon as fit to run.
12.2	The wagon may not be included in trains in its present condition.			Do not fill out the Label I, indicate wagon as unfit to run, giving reasons.

2. INSPECTION OF FITNESS TO RUN FOR AN OVERLOADED WAGON (EXCEEDED LOAD LIMIT)

- **Reference:** Annex 8, point 2: procedure for onward conveyance following identification of overloading and for taking the necessary corrective measures.
- **The measured values of the wheelsets must be documented for the purpose of traceability (Annex 12).**

Wagon checklist for overloading

Inspection of wagon overloading	1. Wheelsets / running gear	<ul style="list-style-type: none"> • Wheelset: > 2% and ≤ 10% overload Perform visual check for damage • Wheelset: > 10% overload Perform visual check for damage and measure the three points after unloading the wagon (empty). • Running gear: Perform visual check for damage, deformation and cracks on the bogie frame.
	2. Springs	Perform visual check for damage, deformation and cracks on the suspension springs and spring suspension.
	3. Brake	Perform visual check for damage, deformation and cracks on the brake rigging
	4. Underframe	Perform visual check for damage, deformation and cracks on the underframe.
	5. Draw/pushing device	Perform visual check for damage, deformation and cracks on the draw and pushing device. Measure the height of the buffers.
	6. Wagon body	Perform visual check for damage, deformation and cracks on the wagon body.

3. INSPECTION OF FITNESS TO RUN FOR AN OVERLOADED WAGON (CONCENTRATED LOADS)

- **Reference:** Annex 8, point 3: procedure for onward conveyance following identification of overloading and for taking the necessary corrective measures.

Wagon checklist for exceeded concentrated loads

Inspection of wagon with exceeded concentrated loads	1. Underframe	Check visually for damage, deformation and cracks on underframe
	2. Draw/pushing device	Check visually for damage, deformation and cracks on draw and pushing device Measure the height of the buffers
	3. Wagon body	Check visually for damage, deformation and cracks on wagon body

4. INSPECTION OF FITNESS TO RUN IN THE EVENT OF IRREGULARITIES IN OPERATIONS

- **Reference:** Annex 1, code 8.1: additional handling of the wagon following irregularities in operations
- **The measured values of the wheelsets must be documented for the purpose of traceability (Annex 12).**

1	2	3	4	5
Number	Question	Answer	Go to number	Comments
Provisions common to vehicles with individual axles and bogies				
1	Is the wagon marked with an interoperability sign conform to points 6.1.1.2 and 6.1.1.3 of Annex 1?	Yes No	2 15.2	
2	Is the loading gauge of the participating RUs respected?	Yes No	3 2.1	
2.1	Have the participating RUs agreed for the wagon to be handed over?	Yes No	3 15.2	
3	Has the wagon derailed?	Yes No	5 4	
4	Has the wagon sustained an abnormal buffering shock or an impermissible operating shock?	Yes No	6 15.1	
5	Is the derailment speed known?	Yes No	7 / 7.1 7 / 7.1	To document in km/h
6	Is the buffering speed known?	Yes No	7 / 7.1 7 / 7.1	To document in km/h
7	Does the wheel tyre thickness conform to the criteria of point 1.1.1 of Annex 1	Yes No	8 15.2	To measure
7.1	or Does the groove marking the minimum thickness for one-piece wheels conform to the criteria of point 1.2.1 of Annex 1?	Yes No	8 15.2	
8	Do the values S_d , S_r , qR and E lie within the permissible limits?	Yes No	9 15.2	For value E , measure at three points.
9	Does the distance between active surfaces (S_R) satisfy the following criteria: – no more than 1426 mm? – at least 1410 mm for a wheel diameter > 840 mm? – at least 1415 mm for a wheel diameter \leq 840 mm?	Yes No	10 15.2	
10	Is the wagon clearly fitted with a uniform type of suspension springs?	Yes No	11 15.2	
11	Does the buffer height lie within the permissible tolerances?	Yes No	12 15.2	To measure
12	Does the wagon (or its load) have superstructures liable to rotate, be displaced or otherwise move during the journey?	Yes No	13 14	

1	2	3	4	5
13	Are there sufficient outwardly visible devices for securing moving superstructures (or their loads) and are they present and effective?	Yes No	14 15.2	
14	Is the wagon otherwise free of safety-critical damage or defects?	Yes No	15.1 15.2	
Results of the examination of fitness to run		Measures		
15.1	The wagon may continue to run at the marked speed as a special consignment.	Fill out the Label I, indicate wagon as fit to run.		
15.2	The wagon may not be included in trains in its present condition.	Do not fill out the Label I, indicate wagon as unfit to run, giving reasons.		

5. EXAMINATION OF THE ABILITY TO RUN OF WAGONS EQUIPPED WITH DET (DERAILMENT DETECTOR)

- **Reference:** Appendix 8, point 4, procedure for onward carriage following the tripping of a DET

Checklist of wagon with DET

Inspection of wagon after tripping of DET	1. Wheel	Perform visual check. Perform visual check for any signs of deformation or cracks on the running surface or on the flange
	2. Axles / running gear	Perform visual check for any signs of damage, deformation or cracks on the axles and the axle boxes
	3. Bogie	Perform visual check for any signs of damage, deformation or cracks on the bogies
	4. Connection between bogie and underframe	Perform visual check for any signs of damage, deformation or cracks on the connection between bogie and wagon body.

-reserved-

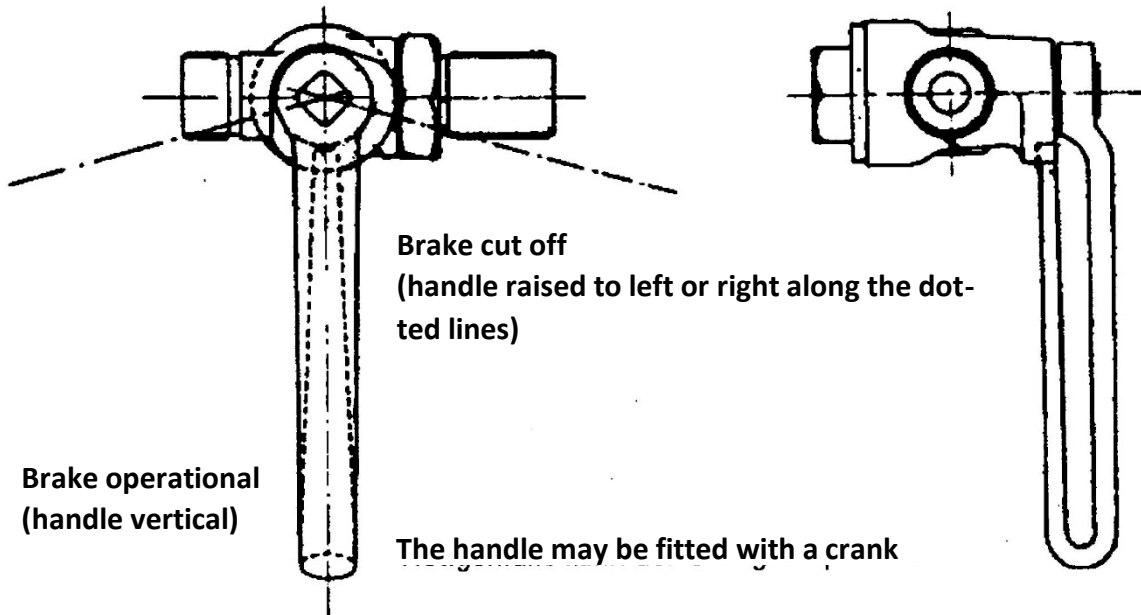
APPENDIX 9, ANNEX 10**Positions of the brake stopcock handle for compressed air brakes****Condition**

On wagons fitted with compressed air brakes, the brake stopcock handle must be pointing vertically downwards when the brake is operational. To cut off the brake, the handle must be turned to the left or right by a maximum of 90°. The handle must meet the conditions set out above.

-reserved-

LABEL K

(RU's symbol) As per catalogue of irregularities, GCU Appendix 9, Annex 1	Wagon Number <input style="width: 20px; height: 20px;" type="text"/> <input style="width: 20px; height: 20px;" type="text"/> <input style="width: 20px; height: 20px;" type="text"/> <input style="width: 20px; height: 20px;" type="text"/> <input style="width: 20px; height: 20px;" type="text"/> <input style="width: 20px; height: 20px;" type="text"/> <input style="width: 20px; height: 20px;" type="text"/> <input style="width: 20px; height: 20px;" type="text"/> - <input style="width: 20px; height: 20px;" type="text"/>	Label K	
Do not reload / To be repaired following			
1 Running Gear	2 Suspension	3 Brake	4 Wagon under-frame and bogie
5 Buffing and draw gear	6 Wagon body	7 Loads and load units	8 Miscellaneous
<input style="width: 20px; height: 20px;" type="text"/> <input style="width: 20px; height: 20px;" type="text"/> <input style="width: 20px; height: 20px;" type="text"/>	<input style="width: 20px; height: 20px;" type="text"/> <input style="width: 20px; height: 20px;" type="text"/> <input style="width: 20px; height: 20px;" type="text"/>	<input style="width: 20px; height: 20px;" type="text"/> <input style="width: 20px; height: 20px;" type="text"/> <input style="width: 20px; height: 20px;" type="text"/>	<input style="width: 20px; height: 20px;" type="text"/> <input style="width: 20px; height: 20px;" type="text"/> <input style="width: 20px; height: 20px;" type="text"/>
Other details _____			
Stamp of issuing office	Date of stamping	Signature	
For issuing RU's use			

blue, size roughly 148 x 210 mm

K labels serve to indicate that there is a problem with the wagon or load unit, but that these can – for the time being – continue to be operated. However, the problems must be resolved prior to reloading; any reloading of the wagon will lead to its withdrawal.

The defect code must be filled out completely in accordance with GCU Appendix 9, Annex 1:

1. Circle or tick the number of the defect group/category
2. Enter the exact defect number in the empty boxes

K labels are to be affixed to both sides of the wagon in a clearly visible position, close to the label-holder or on the inscription plates. The printed version of the K label must contain the data provided for by this annex.

LABEL M

(RU's symbol) As per catalogue of irregularities, GCU Appendix 9, Annex 1	Wagon number <div style="display: flex; justify-content: center; gap: 5px;"> <div style="border: 1px solid black; width: 20px; height: 20px;"></div> <div style="border: 1px solid black; width: 20px; height: 20px;"></div> <div style="border: 1px solid black; width: 20px; height: 20px;"></div> <div style="border: 1px solid black; width: 20px; height: 20px;"></div> <div style="border: 1px solid black; width: 20px; height: 20px;"></div> <div style="border: 1px solid black; width: 20px; height: 20px;"></div> <div style="border: 1px solid black; width: 20px; height: 20px;"></div> <div style="border: 1px solid black; width: 20px; height: 20px;"></div> <div style="border: 1px solid black; width: 20px; height: 20px;"></div> <div style="border: 1px solid black; width: 20px; height: 20px;"></div> <div style="font-size: 24px; margin: 0 5px;">-</div> <div style="border: 1px solid black; width: 20px; height: 20px;"></div> </div>	Label <div style="font-size: 48px; font-weight: bold; margin-top: 10px;">M</div>	
To be inspected			
<div style="border: 1px solid black; padding: 5px; width: 30px; margin: 0 auto;">1</div> Running gear	<div style="border: 1px solid black; padding: 5px; width: 30px; margin: 0 auto;">2</div> Suspension	<div style="border: 1px solid black; padding: 5px; width: 30px; margin: 0 auto;">3</div> Brake	<div style="border: 1px solid black; padding: 5px; width: 30px; margin: 0 auto;">4</div> Wagon under-frame and bogie
<div style="border: 1px solid black; padding: 5px; width: 30px; margin: 0 auto;">5</div> Buffing and draw gear	<div style="border: 1px solid black; padding: 5px; width: 30px; margin: 0 auto;">6</div> Wagon	<div style="border: 1px solid black; padding: 5px; width: 30px; margin: 0 auto;">7</div> Loads and load units	<div style="border: 1px solid black; width: 30px; height: 30px; margin: 0 auto;"></div>
<div style="border: 1px solid black; width: 40px; height: 20px; margin: 0 auto;"></div>	<div style="border: 1px solid black; width: 40px; height: 20px; margin: 0 auto;"></div>	<div style="border: 1px solid black; width: 40px; height: 20px; margin: 0 auto;"></div>	<div style="border: 1px solid black; width: 40px; height: 20px; margin: 0 auto;"></div>
Other details _____			
Stamp of issuing office	Date of stamping	Signature	
For issuing RU's use			

White, size roughly 148 x 210 mm

Label M is used to record wagon damage and defects that do not prevent the vehicle from continuing to run or being reloaded, but which require particular examination by the user RUs.

The defect code must be filled out completely in accordance with GCU Appendix 9, Annex 1:

1. Circle or tick the number of the defect group/ category
2. Enter the exact defect number in the empty boxes

M labels are to be affixed to both sides of the wagon in a clearly visible position close to the label-holder or on the inscription plates. The printed version of the M label must contain the data provided for by this annex.

LABEL R1

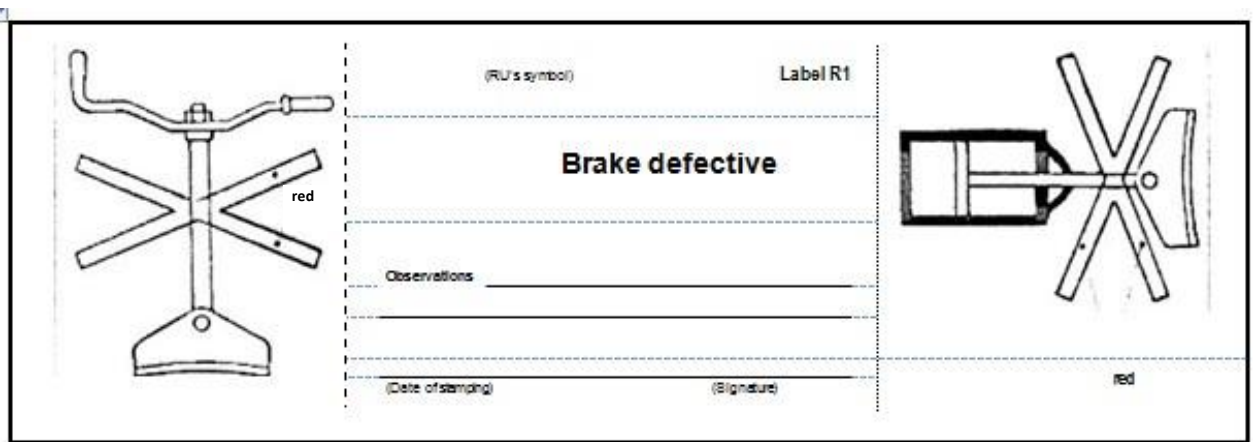



white, size roughly 105 x 210

Label R1 is used to mark wagons with defective brakes or brakes that must not be used for specific reasons. If the brake in question is the handbrake (operated from the wagon platform or from the ground) then the inapplicable right-hand part of the label should be removed, while if the air brake is defective, the left-hand part of the label R1 does not apply and should be removed accordingly.

Label R1 is to be affixed to both sides of the wagon close to the brake stop cock or near the braked weight marking.

LABEL U

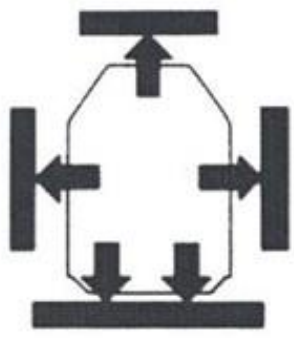
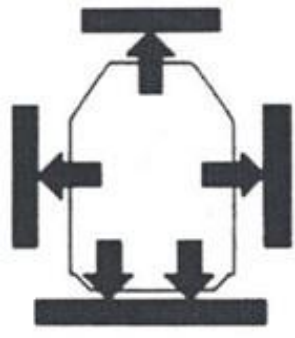
Label for Special Consignments

(RU's symbol)	Label U (RU's symbol)																																																																				
																																																																					
For label-holder	For label-holder																																																																				
<table border="1" style="width: 100%; border-collapse: collapse;"> <tr> <th>Total load</th> <th>Load per metre</th> <th>Maximum axle load</th> </tr> <tr> <td style="text-align: center;">7+8 t</td> <td style="text-align: center;">9 t/m</td> <td style="text-align: center;">10 t</td> </tr> <tr> <td> </td> <td> </td> <td> </td> </tr> </table>	Total load	Load per metre	Maximum axle load	7+8 t	9 t/m	10 t				<table border="1" style="width: 100%; border-collapse: collapse;"> <tr> <th>Total load</th> <th>Load per metre</th> <th>Maximum axle load</th> </tr> <tr> <td style="text-align: center;">7+8 t</td> <td style="text-align: center;">9 t/m</td> <td style="text-align: center;">10 t</td> </tr> <tr> <td> </td> <td> </td> <td> </td> </tr> </table>	Total load	Load per metre	Maximum axle load	7+8 t	9 t/m	10 t																																																					
Total load	Load per metre	Maximum axle load																																																																			
7+8 t	9 t/m	10 t																																																																			
Total load	Load per metre	Maximum axle load																																																																			
7+8 t	9 t/m	10 t																																																																			
(RU's symbol) / (no.)	(RU's symbol) / (no.)																																																																				
..... / /																																																																				
..... / /																																																																				
<table border="1" style="width: 100%; border-collapse: collapse;"> <thead> <tr> <th rowspan="2">Part</th> <th colspan="2">Lateral distance from wagon centre-line on</th> <th rowspan="2">Height above rail level</th> <th colspan="2">Longitudinal distance from end wheelset / bogie centre</th> </tr> <tr> <th>one side</th> <th>other side</th> <th>14 \varnothing_j mm</th> <th>15 \varnothing_{β} mm</th> </tr> </thead> <tbody> <tr> <td>A</td> <td>12a mm</td> <td>12b mm</td> <td>13 mm</td> <td> </td> <td> </td> </tr> <tr> <td>B</td> <td> </td> <td> </td> <td> </td> <td> </td> <td> </td> </tr> <tr> <td>C</td> <td> </td> <td> </td> <td> </td> <td> </td> <td> </td> </tr> <tr> <td>D</td> <td> </td> <td> </td> <td> </td> <td> </td> <td> </td> </tr> </tbody> </table>	Part	Lateral distance from wagon centre-line on		Height above rail level	Longitudinal distance from end wheelset / bogie centre		one side	other side	14 \varnothing_j mm	15 \varnothing_{β} mm	A	12a mm	12b mm	13 mm			B						C						D						<table border="1" style="width: 100%; border-collapse: collapse;"> <thead> <tr> <th rowspan="2">Part</th> <th colspan="2">Lateral distance from wagon centre-line on</th> <th rowspan="2">Height above rail level</th> <th colspan="2">Longitudinal distance from end wheelset / bogie centre</th> </tr> <tr> <th>one side</th> <th>other side</th> <th>14 \varnothing_j mm</th> <th>15 \varnothing_{β} mm</th> </tr> </thead> <tbody> <tr> <td>A</td> <td>12a mm</td> <td>12b mm</td> <td>13 mm</td> <td> </td> <td> </td> </tr> <tr> <td>B</td> <td> </td> <td> </td> <td> </td> <td> </td> <td> </td> </tr> <tr> <td>C</td> <td> </td> <td> </td> <td> </td> <td> </td> <td> </td> </tr> <tr> <td>D</td> <td> </td> <td> </td> <td> </td> <td> </td> <td> </td> </tr> </tbody> </table>	Part	Lateral distance from wagon centre-line on		Height above rail level	Longitudinal distance from end wheelset / bogie centre		one side	other side	14 \varnothing_j mm	15 \varnothing_{β} mm	A	12a mm	12b mm	13 mm			B						C						D					
Part		Lateral distance from wagon centre-line on			Height above rail level	Longitudinal distance from end wheelset / bogie centre																																																															
	one side	other side	14 \varnothing_j mm	15 \varnothing_{β} mm																																																																	
A	12a mm	12b mm	13 mm																																																																		
B																																																																					
C																																																																					
D																																																																					
Part	Lateral distance from wagon centre-line on		Height above rail level	Longitudinal distance from end wheelset / bogie centre																																																																	
	one side	other side		14 \varnothing_j mm	15 \varnothing_{β} mm																																																																
A	12a mm	12b mm	13 mm																																																																		
B																																																																					
C																																																																					
D																																																																					
(RU's symbol)	(RU's symbol) (no.)																																																																				
 /																																																																				
Separate and attach to consignment note																																																																					

White or blue, size roughly 210 x 210/50 mm

Label U is used to indicate Special Consignments (SC) in accordance with number 7, Volume 1, of the Loading Guidelines. The provisions of UIC IRS 50502 apply to consignments of this kind. A further application is specified in Annex 8.

Label U is to be inserted in the label holder on both sides of the wagon.

-reserved-

APPENDIX 9, ANNEX 12

Traceability

The results of measurements by the user RU must be available in electronic format or on paper for a period of at least 2 years. The documentation remains as evidence of activity for the user RU.

Erfassung Radsatzdaten von Wagen im Betrieb Saisie de données d'essieu de wagon en exploitation Registration of axle data for operating wagon

Wagennummer: Numero du wagon: Wagon number:	<input type="text"/>	Gattung: Type: Type:	<input type="text"/>						
Halter: Détenteur: Keeper:	<input type="text"/>								
	E-Mail / Fax: <input type="text"/>								
Grund der Vermessung / Cause de la mesure / Reason for measurement:									
Entgleisung Deraillement Derailment	Thermische Überbeanspruchung Surcharge thermique Thermal overload	Lauffähigkeitsuntersuchung Examen d'aptitude à la circulation Fit-to-run inspection							
<input type="checkbox"/>	<input type="checkbox"/>	<input type="checkbox"/>							
8L 7L	6L 5L	4L 3L 2L 1L							
8R 7R	6R 5R	4R 3R 2R 1R							
Sh									
Sd									
qR									
	1L	2L	3L	4L	5L	6L	7L	8L	
	<input type="checkbox"/>	<input type="checkbox"/>	<input type="checkbox"/>	<input type="checkbox"/>	<input type="checkbox"/>	<input type="checkbox"/>	<input type="checkbox"/>	<input type="checkbox"/>	
	1R	2R	3R	4R	5R	6R	7R	8R	
Sh									
Sd									
qR									
E1									
E2									
E3									
S _R									
Vermessen von / Mesuré par / Measurements taken by:									
Name: Nom:				Vorname: Prénom:					
Sumame: N° de tél.:				First name: Lieu:					
Tel. Nr.:				Ort: Location:					
Tel. no.:									
Spurkranzlehre-Nummer: Numéro de jauge: Gauge no. (wheel flange):									
Spumesslehre-Nummer: Numéro de calibre de mesure: Gauge no. (back-to-back distance):									
Werte eingehalten? Valeurs respectées? Values compliant?	Ja Oui Yes	<input type="checkbox"/>	* Nein * Non * No	<input type="checkbox"/>	Schadensprotokollnummer: Numéro du procès verbal: Damage report no.:				<input type="text"/>
Massnahmen erforderlich? Suite à donner? Follow-up action required?	Ja Oui Yes	<input type="checkbox"/>	Nein Non No	<input type="checkbox"/>	Bemerkungen: Remarques: Remarks:				<input type="text"/>
Wenn Ja, welche? Si oui, laquelle? If so, what?	<input type="text"/>								
Datum: Date: Date:	<input type="text"/>				Unterschrift: Signature: Signature:	<input type="text"/>			

APPENDIX 10

**TO THE GENERAL CONTRACT OF USE
FOR WAGONS**

Wagons – Corrective and Preventive Maintenance

TABLE OF CONTENT

A. CORRECTIVE MAINTENANCE

0. Principle
1. Running gear
2. Suspension
3. Brake
4. Wagon underframe and bogies
5. Buffing and draw gear
6. Vehicle body and accessories

B. HANDLING OF WAGONS AFTER AN INCIDENT

0. Principle
1. Derailment
2. Exceptional impacts
3. Overloading and exceeded concentrated loads
4. Flooding
5. Contact with energised catenary.

C. PREVENTIVE MAINTENANCE

0. Principle
1. Overhaul periodicity

Annex 1 – Signs indicating out-of-roundness on wheels

Annex 2 – Diagram of the Y25 bogie suspension

Annex 3 – European Visual Inspection Catalogue (EVIC) for axles

Annex 4 – Composite brake blocks: when to replace and not to replace

Annex 5 – Verification and handling of grease/oil deposits on wheels and axle boxes

Annex 6 – Coding of interventions

INTRODUCTION

Appendix 10 is intended for use by staff in workshops¹⁾ and collates all the provisions governing the minimum condition for parts (in accordance with the criteria set at international level) on leaving the workshop.

It comprises three chapters.

Chapter A (Corrective Maintenance) is structured in the same way as Annex 1 to Appendix 9 (Catalogue of Irregularities). This structure is as follows:

- Minimum condition and limit values for dimensions
- Indications for corrective maintenance operations – Acceptable and prohibited practices

Chapter B sets out provisions for dealing with wagons after specific incidents which have caused, or potentially caused, damage.

Chapter C contains provisions on the subject of preventive maintenance.

The markings and signs that wagons must carry are given in Appendix 11. Appendix 10 only covers those markings that can lead to a wagon being withdrawn from service under the terms of Appendix 9.

¹⁾ A workshop is a body comprising the management, staff, installations and tools necessary for the execution of corrective and preventive maintenance on wagons and/or their component parts. Mobile units are considered to be workshops if they operate under the authority of a maintenance workshop or if they operate independently and meet the aforementioned conditions.

A. CORRECTIVE MAINTENANCE

0. Principle

Wagon keepers, customers of repair work and workshops must all ensure that wagons are free from defects that are liable to lead to the vehicle being removed from service again, based on the provisions of Appendix 9 on the instructions issued for repairs to be carried out and Appendix 10, Chapter A (and where appropriate also Chapter B) on the actual execution of repair work.

If a RU has marked damages on a freight wagon to be repaired in accordance with Appendix 9, Annex 11 of the GCU before the wagon is brought into a workshop, these markings must be removed by the workshop before the wagon is handed over to an RU. Any marking on the wagon or its parts regarding non-repaired damages must remain.

Chapter A of Appendix 10 contains criteria and guidance to be applied by workshops to remove irregularities as understood by Appendix 9. The measures carried out and documented under Appendix 9 (e.g. Annex 12) do not need to be repeated under Appendix 10.

It is not necessary to apply the whole of Chapter A of Appendix 10 each time a wagon is sent to a workshop, only those provisions relating to the damage that is to be repaired.

For any repair works the workshop must ensure that no other parts or components of the wagon and their coating/painting are damaged by these operations. Appropriate measures (e.g. by protecting parts) must be taken.

Loading residues in the wagon, which hinder repair works, can be removed by the workshop.

Irrespective of the reason for a wagon's withdrawal from service, compliance with those provisions that are marked with an asterisk (*) is required systematically whenever a wagon is sent to the workshop.

If the workshop is not in a position to restore the wagon to the minimum specified condition, the vehicle must be handled in accordance with the keeper's instructions (procedure as per Appendix 9).

1. Running gear

Minimum conditions and limit values for dimensions

Wheelsets

- 1.1 The following four conditions concern the distance between the wheels, measured close to rail level, with the wagon empty or loaded, and the thickness of the flanges. They must all be met concurrently:
- 1.1.1 Distance between the active faces of the wheels, measured 10 mm down from the measuring circles:
- maximum 1426 mm;
 - for wheels with a diameter of greater than 840 mm¹⁾ at least:
 - 1418 mm for the wheelsets of 2-axle wagons with double-link suspension, suitable for running at 100 km/h with a 22.5 t axle-load and a wheelbase of 8 m or more;
 - 1410 mm for the wheelsets of other wagons;
 - at least 1415 mm for wheels with a diameter of less than or equal 840 mm.
- 1.1.2 Distance between the inner faces of tyres or rims of monobloc wheels:
- maximum 1363 mm¹⁾;
 - minimum 1357 mm for wheels with a diameter of greater than 840 mm¹⁾;
 - minimum 1359 mm for wheels with a diameter of less than or equal 840 mm¹⁾.
- The difference between the distances measured for the relevant axles must be ≤ 2 mm ($E_{\max} - E_{\min} \leq 2$ mm). Measurements must be taken in accordance with 1.17.
- 1.1.3 Wheels must show no signs of displacement along the axle;
- 1.1.4 Thickness of the flange of one wheel, measured 10 mm below the running circle:
- minimum 22 mm for wheels of diameter greater than 840 mm;
 - minimum 25 mm for wheels of diameter less than or equal to 840 mm but greater than 760 mm,
 - minimum 27.5 mm for wheels of diameter less than or equal 760 mm
- Flange thickness must not exceed 33 mm, irrespective of the diameter of the wheel.
These values do not apply to wheelsets with tapered flanges (e.g. certain bogies with three or more axles).
- 1.2 The diameter of the wheel running circle must not be less than:
- 840 mm for a nominal diameter of 920 to 1000 mm;
 - 760 mm for a nominal diameter of 840 mm;
 - 680 mm for a nominal diameter of 760 mm;
 - 630 mm for a nominal diameter of 680 mm.
- 1.3 The width of the tyre or rim of monobloc wheels must be:
- maximum 140 mm²⁾,
 - minimum 133 mm.
- 1.4 The height of the wheel flanges must be
- minimum 27.5 mm for wheels of a diameter greater than 760 mm,
 - minimum 29.5 mm for wheels of a diameter greater than 630 mm, but less than or equal to 760 mm and
 - minimum 31.5 mm for wheels of a diameter less than or equal to 630 mm.
- The height of the wheel flanges must be no more than 36 mm.
When using LL soles in wagons with a maximum speed greater than 100 km / h and a wheel diameter **greater than 760 mm**, the limit value for the height of the flange from 27.5 to 32.0 mm must be respected.
These values do not apply to wheelsets with tapered flanges (e.g. certain bogies with three or more axles).
- 1.5 The wheel flange, measured with a gauge, must have a qR value that is always greater than 6.5 mm, with no sharp edges or burrs on the outside profile of the flange, at a distance of more than 2 mm from the upper edge (Appendix 9, Annex 4).

¹⁾ These rules also apply to the intermediate axles of wagons with a 3-axle articulated underframe, but not to the intermediate axles of vehicles other than bogie wagons, nor to the intermediate axles of the bogies themselves.

²⁾ Including the projection formed by the outer edge of the running tread.

- 1.6.1 The wheel tread must not:
- be partly crushed;
 - display wheel flats, shelling, exfoliation or metal build-up:
 - over 60 mm in length for wheels of diameter > 840 mm and axle load ≤ 22.5 t (maximum load limit D or less);
 - over 50 mm in length (maximum load limit E) for wheels of diameter > 840 mm and axle load > 22.5 t;
 - over 40 mm in length for wheels of diameter ≤ 840 mm and > 630 mm;
 - over 30 mm in length for wheels of diameter ≤ 630 mm;
 - have cracks at the transition between the tread and the outer face or on the flange top;
 - display any hollowing or “false flange” deeper than 2 mm or any sharp-edged grooves;
 - show isolated transverse cracks on the tread of wheels with tread brakes (superficial thermal lattice-type cracking – “toad skin” cracking – is permitted).
- 1.6.2 * Wheelsets fitted with LL blocks must be inspected and dealt with as follows:
- Inspect running surfaces in accordance with 1.6.1
 - Visual inspection of the wheels in accordance with the criteria for thermal overload as set out in 1.18.
- 1.7 The lateral face of the wheel and the inner part of the rim or tyre (active face) must not be gouged or marked with sharp-angled notches.
- 1.8 For monobloc wheels, the wear limit of the tyres must be indicated by the bottom of a circular groove concentric with the wheel and traced on the outside surface¹⁾. This groove must always remain fully visible. It may however be partially obscured by dirt providing this does not detract from the possibility of assessing the wear state of the wheel.
- 1.9 The thickness of the wheel tyre measured in the plane of the running circle – defined as the circle where a vertical plane 70 mm from the inner surface of the tyre intersects the wheel tread – must be at least:
- for wagons authorised to run at 120 km/h
(wagons marked “SS” or “**”)..... 35 mm
 - for other wagons²⁾ 30 mm
- 1.10 On a wheel with tyre:
- 1.10.1 The tyre must not be loose.
A tyre is considered loose if at least one of the following conditions is met:
- the tyre has been displaced by rotation on the rim in the plane of the running circle (visible from the fact that the check marks on the tyre and those on the wheel rim are not longer aligned);
 - dull sound when struck;
 - loose tyre clip;
 - presence of rust between the tyre and the rim over more than 1/3 of the circumference;
- 1.10.2 The tyre must show no signs of sideways movement (a tyre can only move sideways if the tyre clip is missing or has become loose, broken or clearly deformed);
- 1.10.3 The tyre clip must not be cracked. When the tyre clip is held in place with a wedge, the wedge must not be missing;
- 1.10.4 Tyres must not be cracked or fissured in the transverse or longitudinal directions.
- 1.11 The wheel hub must not be cracked.
- 1.12 The rim of a spoked wheel must not be broken across.
- 1.13 None of the spokes of a wheel may be broken or cracked.

¹⁾ If exceptionally there are two grooves on a wheel, the outer groove shall indicate the minimum thickness.

²⁾ Including wagons suitable for 120 km/h only when empty.

1.14 A solid or monobloc wheel must not show:

- any defects repaired by welding,
- any cracks.

Minor defects in the wheel body resulting from the casting process are acceptable.

1.15.1 Axles must not:

- show any cracks or any defects repaired by welding;
- be warped;
- have any part worn by friction showing sharp edges (sharp-edged notches);
- show any kind of wear by friction exceeding 1 mm in depth. Brake rods

or other parts must not rub on the axles.

1.15.2 * The prescriptions of Annex 3 are to be applied.

1.16 * Each time the wagon is in the workshop, the wheel+tyre assembly of all wagons fitted with tyres must be checked. The dates on which this verification and the one before it takes place are entered in the maintenance plate specified in Appendix 11, point 7.5 against the initials of the RU and workshops that conducted the check in question.

1.17 If a check is required on the distance between the inner faces of the tyres or rims of monobloc wheels, then this distance shall be measured with a gauge at rail level in at least three points on the wheel, at 120° intervals.

1.18 Monobloc wheels may not display marks of thermal overload caused by the brake:

- clearly burnt paint at the connection between rim and wheel plate (paint cracked/peeled)
- traces of rust at connection between rim and wheel plate
- fusion of brake blocks
- deterioration of wheel tread with build-up of metal (see number 1.6.1 too).
- rim bluish coloured (not uniform) due to overheating
- protruding (flanging) brake blocks

If thermal overload is suspected, a brake test must be performed in accordance with UIC Leaflet 543-1 and the keeper must be consulted in order to obtain instructions. If the keeper does not provide instructions, the wheelsets concerned must be replaced using Form H^R.

Wheels that are able to withstand high thermal stresses and which are marked on the cover of the axle-box casing with an interrupted vertical white line (Appendix 11, point 6.1) are exempt from the measures listed above.

The burnt paint must not be painted over unless agreement for the keeper is guaranteed.

1.19 Wheels shall be tested for out-of-roundness when

- at least two signs of out-of-roundness and wheel tread defects as defined in Appendix 10, annex 1 are detected on a wagon wheel or its immediate environment,
- on the wheels of the axle in question, if there are no signs on the second axle,
- on the wheels of both axles, if there is at least one sign on the second axle,
- they are indicated “Substantial irregular crushing on the edge of the tyre”, as defined in Appendix 10, annex 1, Figure 9 (indication of a particular flat point), irrespective of the presence of any other indication.

In this respect a bogie is to be considered as an axle wagon. The degree of wheel out-of-roundness must not exceed 0.6 mm.

Axle-boxes

1.20 Axle-boxes must not be damaged to the point of no longer being able to hold their lubricant or of allowing dust and water infiltration.

1.21 The sides of the axle-box must cover the guiding surface of the axle guard or of the corresponding bogie parts in all positions of the box, with an overlap of at least 5 mm.

Indications – Accepted and prohibited practices

- 1.22 Axles must not be repaired by welding.
- 1.23 The side faces of the tyres or rims of monobloc wheels must not be painted or covered over with oily or greasy substances, with the exception of the four painted control markings at 90° intervals used to identify tyred wheels (Appendix 11, point 6.2).
- 1.24 Brake rods and other parts must not rub against the axles. If this fault cannot be corrected, the parts in question must be removed or suspended so as to prevent contact. The brake must then be isolated and fitted with labels R1 and K (as per Appendix 9).
- 1.25 Sharp edges on a flange may be removed on the lathe or by grinding.
Any flats or build-up of metal on the running tread may be removed on the lathe with the keeper's agreement.
- 1.26 When an axle is replaced, a wheelset or wheelsets with tyred wheels may not be fitted to a wagon equipped with monobloc wheels.
Tank wagons and wagons loaded with tank containers for the carriage of Class 2 RID products must be fitted with monobloc wheels.
- 1.27 To position the wheelsets on a lathe, the workshop of the user RU may only remove the axle-box covers if they are not fitted with centering holes. All other work on axle-boxes is reserved for the keeper alone.
- 1.28 When reprofiling monobloc wheels with the authorisation¹⁾ of the keeper:
- identify any cracks along the edge of the wheel tread and any sharp-edged dents on the flange and remove by reprofiling,
 - remove any severe radial marks left by the lathe clamping jaws.
- Wheels with an out-of-roundness of ≥ 0.6 mm (see point 1.19) may not be reprofiled. They must be removed and returned to the keeper, suitably marked.
- 1.29 Existing wheelsets fitted with monobloc wheels of steel grades R2, R3, R8 and R9 must be tested by the keeper to check for the absence of cracking and lathe clamp jaw marks. After the test a triangular metal plate embossed with the steel grade is fixed to one of the bolts of the axle-box cover.
- 1.30 Wagons with load-proportional tread brakes for running under SS conditions may not be fitted with monobloc wheels of steel grades R2, R3, R8 or R9.
If thermal overloading is suspected, the provisions of point 1.18 shall apply.
- 1.31 Oil seepage between the axle and wheel hub does not constitute absolute proof of loosening. Displacement must be shown to have occurred.
- 1.32 If there is any sign or suspicion of a hot axle-box, the axle must be replaced.
- 1.33 Bearings shall only be lubricated by the keeper.
- 1.34 No repairs may be carried out on axle-boxes.
- 1.35 If a replacement axle is requested using Form H^R (see Appendix 7), the diameters of the running circles of all the axles on the wagon must be measured and shown on the Form H^R (column B) so that the keeper can supply an axle with a running circle whose diameter is within the difference range permitted by the applicable regulations.

¹⁾ This authorisation may be permanent or issued on a case-by-case basis.

If an axle is replaced without making use of the Form H^R procedure and with no specific indication from the keeper, the difference in the diameters of the running circles must not be greater than:

- 10 mm between the two axles of a bogie
- 20 mm for axle wagons.

1.36 If the workshop identifies connections between the wheelset and the underframe or the bogie (electrical, hydraulic, pneumatic, etc..., other than grounding cables), it cannot disconnect them without having received instructions for dismantling or assembly from the keeper.

1.37 The following checks must be performed after replacing wheelsets:

- Check brake-rigging adjustment
- Check that the brake-rigging adjustment facility is working
- Finally, perform a functional check by applying and disengaging the brake

2. Suspension

Minimum condition and limit values for dimensions

- 2.1 The leaves of a suspension spring must not become longitudinally displaced by more than 10 mm in relation to the buckle.
- 2.2 None of the leaves must be missing, broken or cracked. This provision applies both to parabolic springs and trapezoidal springs.
- 2.3 No helical spring must be broken.
- 2.4 None of the parts necessary for fastening the springs must be missing or broken. None of the spring buckles must be loose.
- 2.5.1 On wagons fitted with leaf spring suspensions, the distance between the buckle of the suspension spring and any parts of the vehicle body, underframe or bogie frame which may be liable to come into contact with it must be at least 15 mm.
- 2.5.2 In respect of the suspension of bogie Y25 and its by-products, the distance between the axle-box housing and the bogie frame must be at least 8 mm.
- 2.6 There must be no recent traces of contact between:
- the spring buckle or other parts of the suspension and the wagon underframe or bogie;
 - the wheels and the body or underframe.
- Once the causes have been remedied, the traces of contact shall be painted over.
- 2.7 The boss of the leaf spring buckle must be properly engaged in its housing (axle-box case or plug). The axle-box case must not be in an abnormal position (twist) as a result.
- 2.8 The component parts of the elastic suspension (rings, rods, intermediate bearings, suspension pins) must not be displaced, missing or broken. The suspension pins must be properly secured.

Indications – Accepted and prohibited practices

- 2.9 The minimum distance between the buckle of the suspension spring and any parts of the vehicle body, underframe or bogie frame which may be liable to come into contact with it may not be restored by:
- placing sheet metal shims between the suspension brackets or bearings and the links, even if these sheets are welded;
 - building up the suspension brackets or bearings by welding.
- 2.10 In the event of damage to the suspension spring of a wagon with a rigid underframe (marked as shown in Appendix 11, point 7.4), both springs of the same axle must be replaced by two others with equivalent deflections. The request for spare parts using Form H (see Appendix 7) must therefore specify that the springs are to be used on a wagon with a rigid underframe.
- For springs with progressive stiffness, it is not necessary to replace both springs. When requesting springs of this kind, the type of spring must be mentioned specifically on Form H.
- 2.11 Repairing suspension springs by welding is prohibited.
- 2.12 Standard parabolic suspension springs for 22 or 22.5 tonne axle-loads can be freely inter- changed in the event of damage.

3. Brake

Minimum condition and limit values for dimensions

Compressed air brakes

- 3.1 On wagons with compressed-air brakes, the handle of the brake isolating valve must be turned vertically downwards when the brake is operational. It must be possible to isolate the brake by a 90° turn on the handle at the most. This handle must satisfy the conditions set out in Appendix 9, annex 10.
- 3.2 The function of the brake position changeover controls must be easily identifiable in accordance with the stipulations of Appendix 11, point 4.3.
- 3.3 The main brake pipe must be in proper working order, to ensure a continuous air supply along the train.

Brake blocks, shoes, disc brakes and brake rigging

- 3.4 The disc brake indicator device must clearly display the “brake on” and “brake released” positions.
- 3.5 None of the brake rigging safety stirrups must be broken, loose or missing.
- 3.6 If wagons have protruding (flanging) brake blocks, it is necessary to eliminate the cause of the protrusion after consultation with the keeper and after he has given instructions. If it is not possible to remedy the cause the wagon must be dealt with in accordance with Appendix 9. A brake block shall be considered protruding if, when it is applied, its external face reaches the external face of the rim. In the event of protruding brake blocks, the wheels must be checked for signs of thermal overload as per point 1.18, Appendix 10.
- 3.7 Cast-iron brake blocks
- 3.7.1 Cast-iron brake blocks that are worn, broken or missing must be replaced.
- The minimum thickness of brake blocks, measured at the thinnest point as seen from the outside, must be 10 mm.
- Brake blocks
- with an incipient crack shall not be considered as broken,
 - shall be considered broken if they are only held in place by their metal reinforcement layer.
- 3.7.2 On double brake block holders (Bgu), when one of the cast-iron blocks is replaced, the other block must also be replaced in all cases.
- 3.8 Composite brake blocks
- 3.8.1 Composite brake blocks **are to be replaced** when the following defects/damage are observed:
- blocks are missing;
 - blocks are broken radially from the friction surface to the plate/edge of the plate (Annex 4, picture 7);
 - friction material shows visible signs of crumbling over more than ¼ of the length of the block;
 - blocks display metal inclusions in the friction surface (Annex 4, picture 1);
 - friction material has become detached from plate over a length of > 25 mm (Annex 4, picture 2);
 - friction material has cracked parallel to the wheel circumference over a length of > 25 mm (Annex 4, picture 4);
 - blocks are less than 10 mm thick, measured at the thinnest point seen from the outside (Annex 4, picture 5).
- 3.8.2 Composite brake blocks **are not to be replaced if:**
- they are partially cracked or cracked straight across at the designated breaking-point (Annex 4, picture 3);
 - there is incipient radial cracking in the block material (Annex 4, picture 6);
 - there are indications of heavy thermal stress such as “white film” on the surface of the contact area and down to a depth of around 10 mm (Annex 4, picture 8);

- there is a branched thermal crack pattern, mainly axial, and a carbonised layer (Annex 4, picture 9).

- 3.8.3 Where several types of brake block are approved and marked as suitable for use on a wagon, all the brake blocks around a single wheelset must be of the same type.
- 3.8.4 On double brake block holders (Bgu), when one of the composite brake blocks is replaced, the other block must also be replaced in all cases.

Brake hose couplings

- 3.9 All wagons must be fitted with brake hose semi-couplings. Wagons with two brake coupling connections at each end for the same main brake pipe must also have two brake semi-couplings at each end.
- 3.10 Brake semi-couplings must not be defective (not airtight).
- 3.11 No part of the brake coupling system (whether connected or disconnected) must hang down within 140 mm of the top of the rails.
- 3.12 The stop cocks must be operable and function correctly. Each air stop cock must be fitted with a stop device in its extreme position that functions correctly.

Indications – Acceptable and prohibited practices

- 3.13 Damaged or loose brake parts that could constitute a safety hazard or cause other damage must be removed or securely fastened. Damage of this kind should be examined in conjunction with point 1.19. In this case, the compressed air brake must be isolated, and the wagon fitted with labels R1 and K.
- 3.14 Work on the pneumatic parts of the brake system (distributors, relay valves, load-weight valves, brake cylinders) and their replacement by workshops shall not be authorised without the agreement of the wagon keeper.
- 3.15 Wagons with platform-operated or ground-operated hand brakes / parking brakes that are inoperable must be repaired. Otherwise, they must be dealt with in accordance with Appendix 9.
- 3.16 Disc brake pads may be replaced exclusively by the keeper, who shall ensure that the brake is in correct working order without needing to be monitored by the userRU.
- 3.17 Missing or damaged brake semi-couplings must be replaced.
- 3.18 Safety stirrups may not be repaired by welding.
- 3.19 All brake tests in application of Appendix 12 of the GCU shall be carried out in accordance with UIC Leaflet 543-1 prior to any action being taken and the brake test sheet including the values measured communicated to the keeper and to the userRU.
- 3.20 Broken or missing brake release pulls are to be replaced.
- 3.21 The following checks must be performed after replacing brake blocks:
- Check brake-rigging adjustment
 - Check that the brake-rigging adjustment facility is working
 - Finally, perform a functional check by applying and disengaging the brake

4. Wagon underframe and bogies

Minimum conditions and limit values for dimensions

Underframe

- 4.1 The underframe must not be visibly deformed or warped.
- 4.2 The flanges of solebars, headstocks and intermediate cross-bars subject to stress from the coupler must not have cracks (transverse cracks) starting at the edge of the flange and extending over more than half the flange width. Longitudinal cracks up to 150 mm are acceptable, except at the points where the suspension brackets are fixed to the solebars. At these points, longitudinal cracks between the flange and the web of the solebar must not exceed 100 mm in length.
- 4.3 Welded joints on underframe crossbars and solebars, and on axle guards and solebars, must not have cracks, nor must any cracks in these parts originate in the joints.
- 4.4 Reserved
- 4.5 Reserved
- 4.6 Wagons with inflammable floors, even if lined with a metal sheet underneath, must be fitted with spark arrestors above the braked wheels. Spark arrestor plates mounted directly beneath the floor are not acceptable.
- This stipulation also applies to flat wagons that have no floor or with a skeletal floor, intended for carrying containers or semi-trailers.
- The spark arrestor plates must not be dislodged or pierced through by rust.
- 4.7 Axle wagons carrying the sign specified in Appendix 11, point 2.10 must be fitted with special spark arrestors.
- 4.8 Axle guards must not be dislodged or broken. They may not have cracks over more than $\frac{1}{4}$ of their cross-section or that are extending towards or close to a fastening point.
- 4.9 No guide-pieces (wear liners) must be missing from the axle guards.
- 4.10 Axle-guard ties must not be missing or broken.
- 4.11 Suspension spring brackets must not be loose, broken, cracked or visibly deformed.

Bogies of all types

- 4.12 Welded joints on bogie frame crossbars and solebars must not be cracked, nor must any cracks in these parts originate in the welded joints. Solebars, crossbars and bolster swing-links must not have any cracks.
- 4.13 The friction surfaces of damping systems acting on the axle-box or bolster guides must not be lubricated.
- 4.14 No side bearers, side bearer parts or springs must be missing or broken.
- 4.15 The bogie must not be lying in an abnormal position in relation to the frame.
- 4.16 The centre casting must not be broken or loose.
- 4.17 The centre casting kingpin must not be missing, broken or loose.

- 4.18 No guide pieces (wear liners) may be missing.
The total length of cracks in the weld beads of the wear liners may not exceed 50% of the total length of the welds.
- 4.19 The earth connections' connecting parts must be checked and fastened if necessary. Missing or damaged earth connections (straps or cables) and connecting parts must be re- placed. Connection points indicate that earth connections must be present.

Y 25 bogies and their derivatives (see Annex 2)

- 4.20 No tare springs must be cracked or broken. Damage of this kind should be examined in conjunction with point 1.19.
- 4.21 No load springs must be displaced or broken. Damage of this kind should be examined in conjunction with point 1.19.
- 4.22 All the tare springs of the bogie must coil in the same direction.
- 4.23 All the pairs of helical springs on a bogie (tare spring/load spring) must coil in opposite directions.
- 4.24 No outer or inner damper ring may be missing, broken or loose. No tappet must be missing (e.g. following a derailment).
- 4.25 No damper cover may come into contact with the bogie frame (faulty damper).
- 4.26 No lifting T must be missing or loose. Damage of this kind should be examined in conjunction with point 1.19.

Indications – Acceptable and prohibited practices

- 4.27 Cracked steps must be replaced by the workshop of the user RU. Repairs involving welding are prohibited.
- 4.28 When the spark arrestor plates of a wagon are missing or damaged without the possibility of proper repairs being carried out, the brake must be isolated and the wagon dealt with in accordance with Appendix 9 (labelling).
- 4.29 Breakages, damage and cracks on solebars, intermediate crossbars, underframe headstocks (wagon or bogie) and welded joints must only be repaired by welding at a workshop selected by the keeper. However, the workshop of the user RU may, exceptionally, be authorised to carry out welding work for the sole purpose of repairing cracks or breakages on underframe profiles, to make it possible for an empty wagon to be returned home.
- 4.30 Wagons whose underframe is warped or deformed and which are not fit to run must be specially treated, in agreement with their keeper.
- 4.31 Damaged axle guards and suspension spring brackets riveted to the underframe can be straightened or replaced by the workshops.
- 4.32 If the rivets or bolts used to fix the axle guards in place are loose or missing, they shall be replaced by the workshops with self-locking screw bolts or bolts locked by split pins.
- 4.33 The friction surfaces of damping systems acting on the guides of the axle-boxes or swiveling bolster must not be lubricated. Any grease must be removed insofar as possible without demounting. In this case the wagon must be fitted with a Label M.
- 4.34 Welding of wear liners on bogies is only authorised after the axles have been demounted and following instructions from the keeper. Rewelding of cracks on wear liners is not allowed.

- 4.35 Welding and oxygen-cutting are strictly prohibited during the mounting of screw assemblies using high-resistance screws (class 8.8 or above) or bolts (class 8 or above) to attach steps, handles and centre castings.
- Screw assemblies are to be executed in compliance with the rules (e.g. sufficient projection of screw, tightening torque, self-locking screws etc.).
- Welding and oxygen-cutting are prohibited on self-locking screws, irrespective of the type of locking (synthetic or metallic).
- 4.36 During the mounting of screw assemblies with normal-resistance screws (below class 8.8) or bolts (below class 8) to attach steps, handles and centre castings, welding and oxygen-cutting are only permitted if authorised by the keeper. Screw assemblies are to be executed in compliance with the rules (e.g. sufficient projection of screw, tightening torque, self-locking screws etc.).
- Welding and oxygen-cutting are prohibited on self-locking screws, irrespective of the type of locking (synthetic or metallic).

5. Buffing and draw gear

Minimum condition and limit values for dimensions

Buffing gear

- 5.1 The height of the centre of the buffing gear, measured vertically from rail level and at rest, must be:
- for empty wagons.....maximum 1 065 mm
 - under maximum load.....minimum 940 mm.
- 5.2 In abeyance.
- 5.3.1 Buffers at the end of the wagon and buffer fixing bolts must not be missing. All fixing bolts must be tight.
- 5.3.2 * For permanently coupled wagon units, neither buffers nor buffer fixing bolts must be missing at the fixed coupling point. All fixing bolts must be tight.
- 5.4 The locking or fastening devices holding the buffer plungers in place must not be missing or damaged.
- 5.5 The buffer spring and the other parts of the buffer must not have cracks or damage liable to impede the proper working of the buffer. It is acceptable for one buffer at each end of the wagon to be compressible by hand by a maximum of 15 mm.
- 5.6.1 Buffer casings must not be damaged to the extent that their fastenings are no longer sufficiently robust or that buffer plunger guidance is no longer sufficiently guaranteed. The buffer casings and plungers must not be cracked.
- The buffer's visible guide surface must present no more than 2 sharp-edged grooves, each more than 2 mm deep and 60 mm long. This examination shall be performed as a visual inspection, and as a measurement in case of doubt only.
- 5.6.2 For buffers which are to be lubricated, the visible guide surface must be adequately lubricated. Should lubrication be needed, any grease residue must first be removed. Lubrication must then take place by applying a thin layer of grease across the periphery of the guide surfaces.
- 5.7 * There must be no missing or loose rivets or fixing bolts on the buffer heads. This also applies to permanent couplings.
- 5.8 * The contact surfaces of the buffer heads must be sufficiently lubricated. This also applies to permanent couplings.
- 5.9.1 * The contact surfaces of buffer plates must not have more than 2 sharp-edged grooves measuring > 3 mm in depth and > 50 mm in length. This also applies to permanently coupled wagon units.
- 5.9.2 * The buffer plates with wear pads or plastic plates must not
- be broken, cracked right through, missing
 - have crumbling/melding > 3 mm in depth and > 25 mm in length
 - have loose or missing fastening bolts.

5.10 On wagons fitted with anti-crash devices, these devices must not show signs of having been triggered, nor any trace of deformation.

The anti-crash devices have been triggered if

- the arrow marker is not fully visible,
- the deformation marker is missing or deformed,
- the length of the buffer is visibly shortened,
- the buffer casing is deformed or destroyed.

Draw gear

5.11 No part of the screw coupling gear (coupled or uncoupled) must hang down within 140 mm of the top of the rails.

5.12 The length of the screw coupler must be such that the buffers can at least be brought into contact.

5.13 The screw couplers and draw hooks must not be missing. Any clearance between the chain link and the screw must be less than 10 mm.

5.14.1 The screw coupler must be easy to operate and the coupling screw must be sufficiently lubricated.

5.14.2 The screw couplers and draw hooks must not be cracked. Nor must they have sustained any damage liable to prevent the vehicle from being coupled to another vehicle or to stop them performing properly.

5.15 Draw bars must not be broken or cracked. Sleeves, bolts or cotter pins must not be broken or missing.

5.16 Draw hook rods and guides must not be worn to such an extent that the draw hook is able to rotate on its axis within the guides.

5.17 If non-continuous draw gear is used, none of the following types of damage may occur:

- fracture or defect on a volute or ring spring;
- deterioration of a rubber or elastomer spring.

5.18 If continuous draw gear is used, none of the springs must not be fractured or damaged. The draw gear guides must not have cracks that are liable to prevent the draw gear from functioning properly.

5.19 The draw hook pin on the screw coupler must be at least 50 mm in diameter.

5.20 When the suspension device on the screw coupler is inoperable or missing, it must be re-paired or replaced.

Indications – Acceptable or prohibited practices

5.21 Use of welding to repair draw gear is prohibited. However, electric welding may be used for temporary repairs to broken or cracked draw bars. The wagons concerned must be handled in accordance with Appendix 9 and transported at the rear of the train.

5.22 Wagons fitted with long-stroke shock absorbers whose sliding part is visibly not in the middle position must be dealt with in accordance with Appendix 9.

5.23 When a buffer at one end of the wagon is damaged, both buffers must be replaced. The replacement buffers must be identical. In the case of buffers with a stroke of 105 mm, 130 mm or 150 mm, the replacement buffers must however belong to the same category as the buffers removed. Also, for buffers with a stroke of 130 or 150 mm, the replacement parts must have the same design characteristics as the buffers removed. Buffers with wear inserts in the buffer heads must only be replaced in accordance with the keeper's instructions.

- 5.24 Missing buffer head fastening rivets may be replaced using appropriate screw fasteners. Any sharp edges on the buffer head contact surfaces shall be removed by grinding.
- 5.25 It is forbidden to carry out welding or blowtorch work on or near buffers marked on the casing with a yellow dot (see Appendix 11, point 7.9.4).
- 5.26 Damaged or deformed anti-crash devices shall be dealt with in accordance with the keeper's instructions. Buffers fitted with anti-crash devices must, in principle, be replaced by identical buffers. If anti-crash devices are not available, standard buffers may, exception- ally, be fitted to enable the wagon to continue its journey to be unloaded or sent to the workshop for repairs. In this case, a K Label as shown in Appendix 9, annex 11 shall be affixed, together with the sign shown in Appendix 11, points 5.4 or 5.5.
- 5.27 Permanently coupled wagons must be coupled and uncoupled in line with the keeper's instructions.
- 5.28 Welding and oxygen-cutting are strictly prohibited during the mounting of screw assemblies using high-resistance screws (class 8.8 or above) or bolts (class 8 or above) to attach buffers and draw gear. Screw assemblies are to be executed in compliance with the rules (e.g. sufficient projection of screw, tightening torque, self-locking screws etc.).
- Welding and oxygen-cutting are prohibited on self-locking screws, irrespective of the type of locking (synthetic or metallic).
- 5.29 During the mounting of screw assemblies with normal-resistance screws (below class 8.8) or bolts (below class 8) to attach buffers and draw gear, welding and oxygen-cutting are only permitted if authorised by the keeper. Screw assemblies are to be executed in compliance with the rules (e.g. sufficient projection of screw, tightening torque, self-locking screws etc.). Welding and oxygen-cutting are prohibited on self-locking screws, irrespective of the type of locking (synthetic or metallic).

6. Vehicle body and accessories

Minimum condition and limit values for dimensions

Provisions applicable to all wagons:

- 6.1 The wagon body, superstructures and all additional devices must not be damaged in a way that could lead to deterioration or loss of the load or constitute a safety hazard for railway operations and/or a risk for persons or the environment.
- 6.2 The wagon body and its parts must not foul the loading gauge.
- 6.3 No part of the heating coupling and other coupling devices (coupled or uncoupled) must hang down within 140 mm of the top of the rails.
- 6.4 Moving parts of the wagon and the devices used to control them must not have visible damage that prevents them from functioning normally.
- 6.5 None of the wall or floor boards must be missing, broken, split or damaged to the point where the load might be lost or damaged as a result of damp.
- 6.6 The sliding doors must be mounted in such a way that they cannot come off their runners. Drop sides must be secured so they cannot part from their hinges or fastenings.
- 6.7 It must be possible to close and lock all doors and sliding walls completely and securely. They must not be missing or have come out of their runners.
- 6.8 The doors must have no deformation or holes that could lead to loss of the load.
- 6.9 No guiding or locking systems (door frames, hinges, bolts, latch hooks or handles) must be missing or be dislodged, broken or deformed.
- 6.10 Two handrails for use by shunting staff (during coupling) must be fitted below each head- stock. All steps, handrails, ladders and walkways must be safe to use and free from cracks. This provision also applies to their fastenings and supporting structures.
- 6.11 Steps may be twisted, deformed or tilted to a maximum of 20 mm.
- 6.12 The clearance between handrails and the nearest part of the wagon must be at least 60 mm.
- 6.13 Plates carrying markings, folding panels and label-holders must not be missing and must be properly secured.
- 6.14 The following markings as specified in Appendix 11 must be fully present and legible:
 - wagon number and signs as depicted in Appendix 11 points 2.1 and 2.2;
 - tare;
 - braked weight of the hand brake;
 - load limits;
 - capacity of tank wagons;
 - goods for which tank wagons are used;
 - length over buffers of wagon;
 - the high voltage warning sign "Caution – Electrical hazard" on wagons fitted with steps or ladders placed at a height of more than 2 m;
 - maintenance (overhaul) plate;
 - signs indicating the presence of anti-crash devices;
 - diagonal stripes for wagons with long-stroke shock absorbers.

Additional provisions for covered wagons:

- 6.15 Ventilation flaps must not be missing or damaged.
- 6.16 Control gear, shutters and retaining brackets must not be unhooked, dislodged or de- formed.
- 6.17 The roof cover and weatherboard must not be loose or deformed.
- 6.18 It must be possible to close and lock opening roofs to prevent them from coming open unexpectedly. None of the controls must be missing, deformed or inoperable. The roofs must lie in their runners.
- 6.19 It must be possible to use roof hatches correctly.

Additional provisions for open wagons:

- 6.20 It must be possible to close and lock the side walls to prevent them from opening unexpectedly.
- 6.21 It must be possible to close and lock the end flaps to prevent them from opening unexpectedly.
- 6.22 The locking systems for the end flaps (pins, camshafts, rings, shafts) must not be missing, broken or cracked. They must be fit for use.
- 6.23 The cantrails must not be deformed, broken or cracked so as to foul the gauge.

Additional provisions for flat wagons:

- 6.24 It must be possible to lift and secure the drop sides.
- 6.25 The hinges, pins and securing devices of the drop sides must not be missing or broken. They must be fit for use.
- 6.26 Detachable, swiveling and retractable stanchions must not be missing, broken or cracked.
They must not be deformed, broken or torn to the extent of fouling the loading gauge. This provision also applies to the stanchion mountings and securing devices.
The stanchion fastenings must be effective.
- 6.27 Folding bolsters must not be loose.

Additional provisions for tank wagons^{1),2),3)}:

- 6.28 * Tanks must not have sharp-edged deformations (even if there is no loss of the goods carried).
- 6.29 * Cracks in tank cradles are not accepted. If the tank is fastened to the underframe using bolts or rivets, none of these must be missing.
- 6.30 * The welded joints on the tank and the underframe must not be cracked.
- 6.31* Ladders, platforms and guard rails must be safe to use and must not be loose.
- 6.32* Tank cladding, sunroofs and insulation must not have come loose.

¹⁾ The points indicated by a * are mandatory only for RID tank wagons (visual inspections).

²⁾ Tank wagons are wagons used for transporting liquids, gases, powdered or granular goods (visual inspections)

³⁾ The corrective maintenance operations covered under points 6.28 - 6.30 and 6.33 - 6.38 may only be performed on RID tank wagons with the keeper's consent (e.g. Model H)

- 6.33 The tanks and their filling and emptying devices must not leak. It must be possible to seal them hermetically, with the exception of the automatic ventilation devices (Appendix 11, point 6.3).
- 6.34 * Screw caps must not be missing.
- 6.35 * The blind flanges must not be missing or loose. All the fastening screws must be in place.
- 6.36 The emergency control screw for the emptying valve must be unscrewed.
- 6.37* The indicator on the emptying valve must be in good condition and legible.
- 6.38 The dome hatch must be present. It must be possible to close it hermetically.

Additional provisions for mechanically sheeted wagons:

- 6.39.1 It must be possible to close and lock the mechanical sheeting correctly (indicator visible). This requirement also applies to the end hoops' top locking system.
- 6.39.2 Provided that no repair instructions have been provided by the keeper, repairs are carried out using a repair kit on the basis of cold bonding in accordance with the instructions provided by the repair kit manufacturer.

Additional provisions for wagons with telescopic hood:

- 6.40 It must be possible to close and lock the hoods correctly, keeping them in the guide rails provided.

Additional provisions for flat bogie wagons for carrying road and rail vehicles:

- 6.41 The moving headstocks at each end must not be damaged. It must be possible to lock them from both sides.
- 6.42 The seating device, seating device bolts, securing chains and chain eyes must be fit for use.

Additional provisions for ACTS carrier wagons:

- 6.43 The swivel frames must not be damaged to the extent that they cannot be properly fastened and locked.
- 6.44 The snap locks must function properly.
- 6.45 The central lock must function and clearly show the "locked" position.
- 6.46 It must be possible to erect the stanchions correctly.

Additional provisions for car-carrying wagons:

- 6.47 It must be possible to raise and secure the end boards and crossing gangways.
- 6.48 The upper loading deck must rest on the supporting brackets and be properly secured. The indicator device must function.

- 6.49 None of the accessories must be loose (scotches, wheel scotch guide-pieces, crank handles, lifting or lowering device, end boards, crossing gangways).

Additional provisions for self-discharging wagons:

- 6.50 It must be possible to close and lock all valves and hatches.
- 6.51 No part of the locking and discharging system must be loose.

Indications – Acceptable and prohibited practices

- 6.52 When deformation has occurred and the vehicle gauge profile must be verified, the provisions of point 4, Section 1 of the Loading Guidelines shall be applied.

Exception: for wagons built in accordance with UIC Leaflet 505/IRS 50505 and whose width exceeds that obtained by application of point 4, Section 1 of the Loading Guidelines (these wagons are not specially marked), the wagon keeper should be contacted to find out the permitted width of the wagon.

Failing a reply from the keeper, point 4 of Section 1 of the Loading Guidelines shall be applied for safety reasons.

- 6.53 Parts made from plastic or plywood (e.g. roof covers and side wall panels) must not be repaired with nails. These wagons carry the sign specified in Appendix 11, point 2.14.
- 6.54 Rivets used for fastening the tanks of tank wagons may be replaced by bolts when missing.
- 6.55 Welding work on tanks may only be carried out by approved workshops with the keeper's agreement.

B. HANDLING OF WAGONS AFTER SPECIFIC INCIDENTS

0. Principle

After specific incidents, the user RU must ensure that any damage or presumed damage that the wagon has suffered will not give rise to consequential damage. To this end, this chapter sets out a number of provisions to be complied with when returning the wagon to running order. The decision on whether the wagon is fit for use rests with the keeper.

The user RU shall perform additional tests to ensure that no wagon damage, which may affect the wagon's fitness for use, has not occurred. In the case of tank wagons, wagons with specific superstructures, which are not described in point 6 of chapter A, and if the workshop is not certain that the points defined are sufficient, the RU contacts the keeper to request specific instructions to restore the wagon's ability to run. If workshops are unable to restore the wagon to the minimum condition specified, the wagon shall be referred to the keeper for a decision on what action to take (in accordance with Appendix 9).

The specific incident and the wagon associated with the number(s) of the wheelset(s) concerned must be indicated to the keeper.

1. Derailment

The inspection must be adapted according to the information available.

If a wagon derails, the following checks must be performed at a minimum:

- wheelsets, in accordance with Chapter A, 1.1.2, 1.1.3, 1.6.1, 1.6.2, 1.8, 1.10 to 1.17, 1.20 and 1.21 as well as notches in the wheel flange which are due to the derailment
- springs, in accordance with Chapter A, points 2.1 to 2.8
- underframe, running gear and bogies in accordance with Chapter A, points 4.1 to 4.6, 4.8 to 4.12, 4.14 to 4.18, 4.20, 4.21, 4.24, 4.25, 4.26
- traction and buffing gear: Chapter A, points 5.1 to 5.6.1, 5.7, 5.9, 5.10, 5.13, 5.14.2, 5.15, 5.17, 5.18, 5.20
- Vehicle body and accessories according to point 6 of chapter A, if applicable
- for tank wagons, inspection of the tank in accordance with the keeper's instructions
- inspection of damages at grounding cables

In the case of wagons derailed at a speed of >10 km/h, or if the speed cannot be established, the wheelsets concerned must be removed without prior inspection.

Before being sent, the wheelsets that have derailed must be clearly marked so that the keeper or the keeper's workshop can recognise that the wheelset has derailed (**Model H^R**).

2. Exceptional impacts

When a wagon has suffered an exceptional impact, it is assumed that the speed of impact was greater than 12 km/h.

In this case, the following tests shall be carried out:

- wheelsets in accordance with Chapter A, 1.1.2, 1.1.3, 1.6.1, 1.6.2, 1.8, 1.10 to 1.17, 1.20 and 1.21
- springs in accordance with Chapter A, points 2.1 to 2.8
- underframe, running gear and bogies in accordance with Chapter A, points 4.1 to 4.6, 4.8 to 4.12, 4.14 to 4.18, 4.20, 4.21, 4.24, 4.25, 4.26
- traction and buffing gear: Chapter A, points 5.1 to 5.6.1, 5.7, 5.9, 5.10, 5.13, 5.14.2, 5.15, 5.17, 5.18, 5.20
- Vehicle body and accessories according to point 6 of chapter A, if applicable
- tank wagons: inspection of the tank in accordance with the keeper's instructions.

If the speed of impact is found to have exceeded 25 km/h, the wheelsets must be removed.

Before being sent back, the dismantled wheelsets must be marked so that the keeper or the workshop can identify them as having been subject to an exceptional impact (**Model H^R**).

3. Overloading and exceeded concentrated loads

When a wagon is brought in because it has been overloaded (whole wagon, bogie or wheelset) or the concentrated loads are exceeded, the following inspections and measurements should be carried out according to the overload percentage in relation to the maximum load for the wheelset concerned:

	Overload %	Maintenance operations
1	0% to 2% (inclusive)	– No operation
2	> 2% to 10% (inclusive)	<ul style="list-style-type: none"> – inspection of axle and wheels in accordance with Chapter A, 1.1.2, 1.1.3, 1.6, 1.8, 1.10 to 1.18, 1.20 and 1.21. – visual inspection of suspension springs for ruptures, cracks and deformation – visual check for traces of contact on the springs and parts of the underframe or bogie – inspection of the underframe, running gear and bogies in accordance with Chapter A, points 4.1 to 4.6, 4.8 to 4.12, 4.14 to 4.18, 4.20, 4.21, 4.24, 4.25 – transmission of information on overloading and inspection results to the keeper
3	> 10%	<ul style="list-style-type: none"> – removal of the wheelset and transmission of information on overloading to the keeper by means of Model H^R – visual inspection of suspension springs for ruptures, cracks and deformation – visual check for traces of contact on the springs and parts of the underframe or bogie – inspection of the underframe, running gear and bogies in accordance with Chapter A, points 4.1 to 4.6, 4.8 to 4.12, 4.14 to 4.18, 4.20, 4.21, 4.24, 4.25 – transmission of inspection results to the keeper
		<ul style="list-style-type: none"> – visual inspection of suspension springs for ruptures, cracks and deformation – visual check for traces of contact on the springs and parts of the underframe or bogie – inspection of the underframe, running gear and bogies in accordance with Chapter A, points 4.1 to 4.6, 4.8 to 4.12, 4.14 to 4.18, 4.20, 4.21, 4.24, 4.25 – transmission of inspection results to the keeper

All of the information provided to the keeper must relate to the maximum permissible load per wheelset or the maximum permissible concentrated loads. If this value is not indicated on the wheelset, the maximum permissible line classification marked on the wagon must be taken into account.

If the overloaded wheelsets are marked with a white cross on the axle, the maintenance operations described in the table above shall be limited to the marked axles only.

In case of doubt, the wheelset(s) should be replaced without prior inspection and marked as having been subject to overloading (Model H^R) before being sent back to the wagon keeper.

4. Flooding

The following inspections and measures shall be performed on wagons that have stood with all or part of their underframe under water in order to return them to running order, where appropriate after cleaning:

- replacement of all wheelsets,
- before they are sent back, all the wheelsets that have been subject to flooding must be clearly marked so they are recognisable to the wagon keeper or his workshop as having suffered potential damage from water (Model H^R),
- visual inspection of suspension springs to check for corrosion that could lead to a rupture of the spring,
- replacement of any buffers that were below the waterline,
- draining of water from the main brake pipe. The wagon should be handled with the brake isolated in accordance with Appendix 9.

5. Contact with energized catenary

When parts of the wagon body have come into contact with energised catenary wires, the axle-boxes are likely to have sustained damage from the passage of electric current.

In cases such as these, the following measures shall be taken:

- replacement of all wheelsets on the wagon,
- before they are sent back, all the wheelsets that have been affected by the electric current must be clearly marked so they are recognisable to the wagon keeper or his workshop as having suffered potential damage from electric current (Model H^R),
- inspection of the vehicle body to check for other damage with potential consequences for the wagon's fitness to run;
- also check for burn marks or evidence of fusion, particularly on grounding cables, springs, suspension and other spring connectors.
- for tank wagons, inspect the tank in accordance with the keeper's instructions.

C. PREVENTIVE MAINTENANCE

0. Principle

The keeper must ensure that wagons are restored to a condition making them fit for normal service in terms of load safety and conservation.

To do so, he has recourse to the services of an Entity in Charge of Maintenance, one of whose responsibilities (as set out in EU Regulation 2019/779 and the corresponding COTIF rules) is to define a preventive maintenance plan and instructions, which the keeper must apply.

1. Overhaul periodicity

- 1.1 The date of last overhaul and the overhaul periodicity stipulated by the ECM must be indicated on a maintenance plate as defined in Appendix 11.
- 1.2 A wagon's overhaul period may be extended by 3 months if the keeper so decides, in which case the wagon shall receive the "+3M" marking.
- 1.3 Specific provisions for tank wagons:

Tank wagons for which the date (end of month) of the next tank test has become due (Appendix 11, point 6.4) shall be handled in accordance with Appendix 9.

Appendix 10, Annex 1

SIGNS INDICATING OUT-OF-ROUNDNESS OF WHEELS

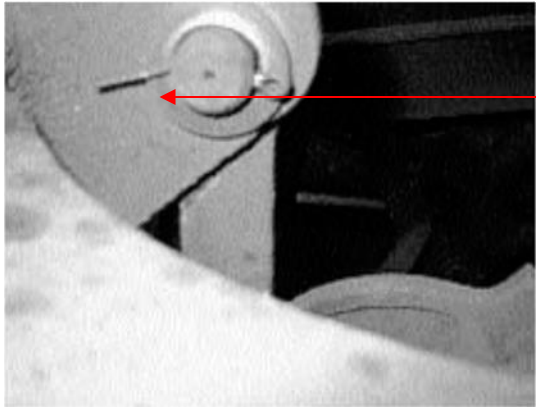
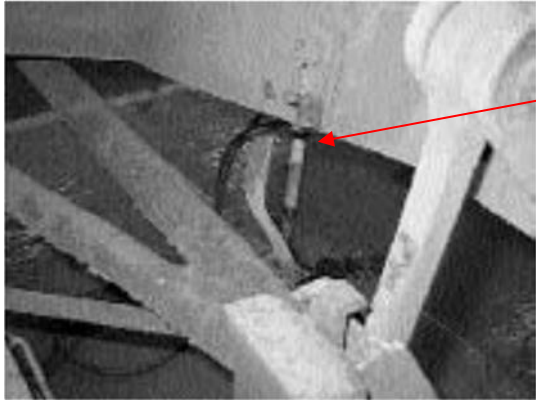
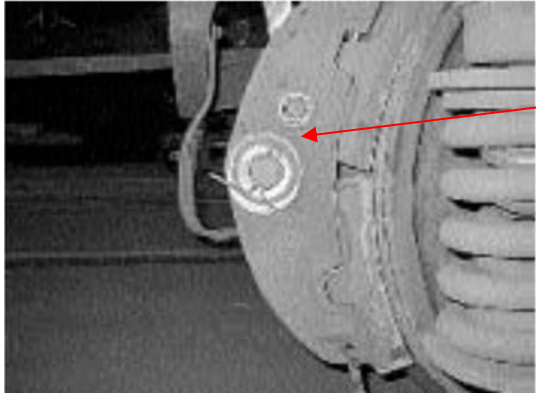
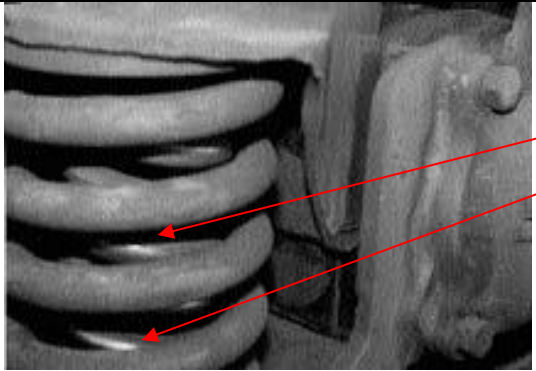
	<p>Fig. 1: Sheared-off pin</p>
	<p>Fig. 2: Broken safety stirrup</p>
	<p>Fig. 3: Shiny traces on the brake triangle end washer</p>
	<p>Fig. 4: Shiny traces on the load spring</p>

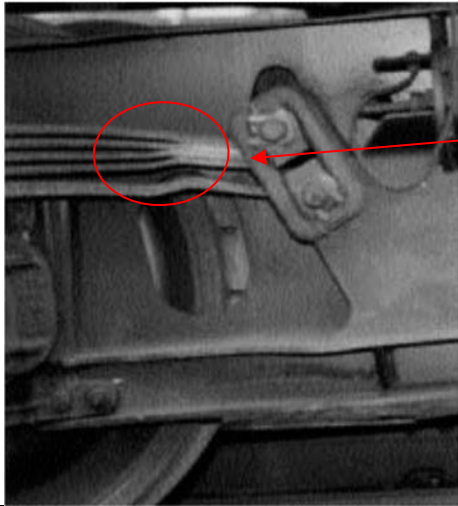

Fig. 5:
Areas shiny with wear, visible from the outside, on the friction points of the spring leaves of parabolic spring suspensions

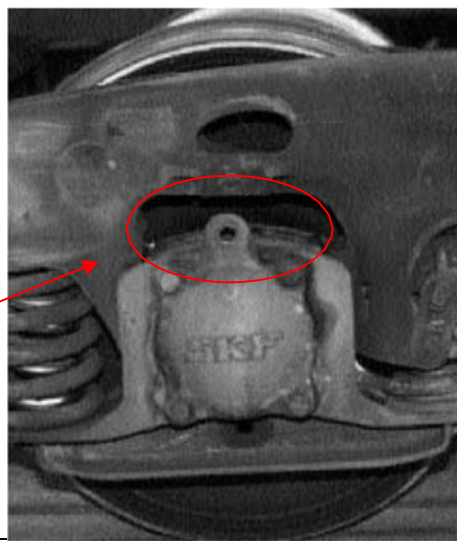

Fig. 6:
Lifting safety catch missing or loose

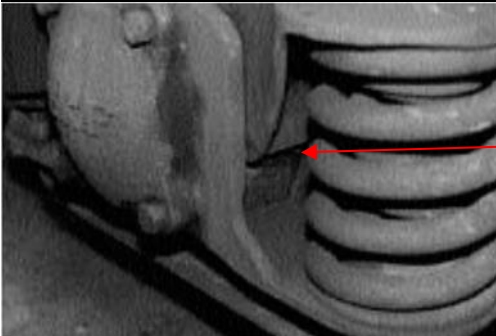

Fig. 7:
Manganese wear plates on bogies and axle-boxes detached



Fig. 8:
Irregular contact surface on the edge of tyred wheel rim

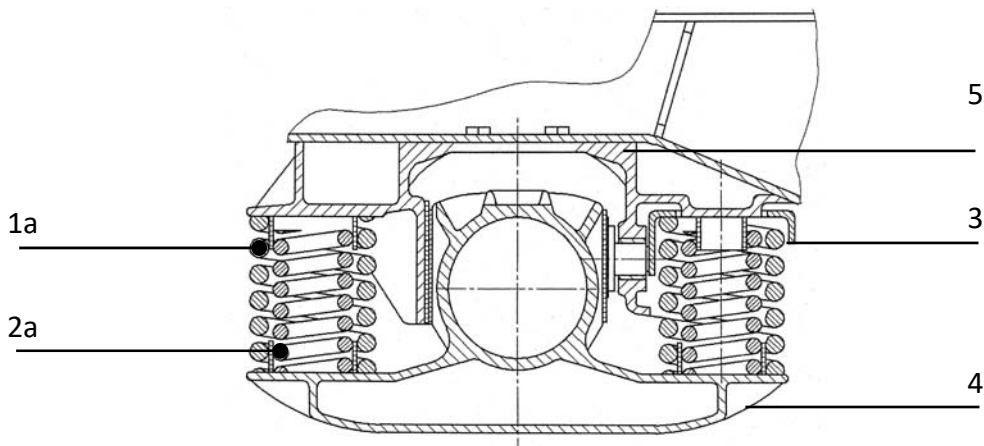

Fig. 9:
Major irregular crushing of the edge of the tyred wheel rim

Appendix 10, Annex 2

DIAGRAM OF THE Y25 BOGIE SUSPENSION

Figure 1 – Bogie with springs for axle-load of 20 tonnes



- 1a tare spring for 20 t axle-load, right-wound
- 2a load spring for 20 t axle-load, left-wound
- 3 spring cap
- 4 axle-box
- 5 axle-box guide piece

Figure 2 – Bogie with springs for axle-load of 22.5 tonnes

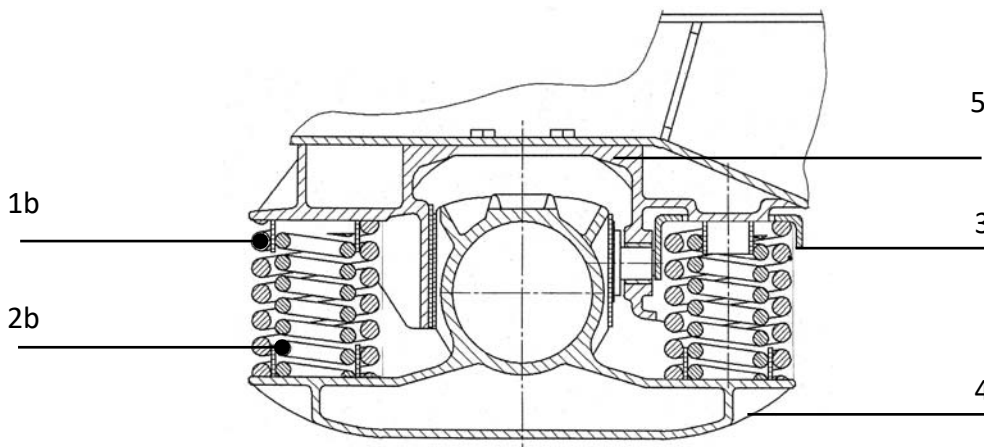

- 1b tare spring for 22.5 t axle-load, left-wound
- 2b load spring for 22.5 t axle-load, right-wound
- 3 spring cap
- 4 axle-box
- 5 axle-box guide piece

Appendix 10, Annex 3

EUROPEAN VISUAL INSPECTION CATALOGUE (EVIC) FOR WHEELSETS

Preamble

1. The documents contained in this annex describe procedures for the visual inspection of wagon axles.

Chapter A:

European visual inspection catalogue (EVIC) for wagon axles

Chapter B:

Implementation guide for the European visual inspection catalogue (EVIC) for wagon axles

2. Axles requiring removal following EVIC must be marked in a clearly visible and indelible manner with "EVIC", the defect code and the number of the corresponding wheelset. This data must also be noted on Form H^R (Appendix 7 of the GCU) when placing an order for replacement wheelsets from the wagon keeper.
3. If a wagon is sent to the workshop because of axle damage according to Appendix 9 of the GCU, the axles of the wheelsets concerned shall not be subjected to visual inspection. Only the provisions of Appendix 10 of the GCU on corrective and preventive maintenance shall be applicable to these wheelsets.

A. European visual inspection catalogue (EVIC)

The following pages represent the complete defect catalogue.

**EUROPEAN VISUAL
INSPECTION CATALOGUE
(EVIC)
FOR WAGON AXLES**

DAMAGE CATEGORY

Painted axles		
30	No defects or admissible defects (pitting)	OK
31	Mechanical damage – sharp edged circumferential fluting	X (not ok)
32	Mechanical damage – smooth edged circumferential groove	X (not ok)
33	Mechanical damage – sharp edged notching	X (not ok)
34	Mechanical damage – cracks	X (not ok)
35	Surface damage – large and heavily corroded areas	X (not ok)
36	Surface damage – single, deeply pitted corrosion scars	X (not ok)
37	Coating damage – with or without corrosion	C
Unpainted axles		
40	No defects – admissible surface appearance	OK
41	Mechanical damage – sharp edged circumferential fluting	X (not ok)
42	Mechanical damage – smooth edged circumferential groove	X (not ok)
43	Mechanical damage – sharp edged notching	X (not ok)
44	Mechanical damage – cracks	X (not ok)
45	Surface damage – very heavy, deep and large corrosion	X (not ok)
46	Surface damage – single, deeply pitted corrosion scars	X (not ok)
All axles		
50	Abutment area	X (not ok)

CRITERIA FOR PAINTED AXLES

30 No or admissible defects found on the axle surface - smooth pitting		Painted axles
Salient information:		
	Pitting may occur either round the entire perimeter or intermittently and is characterised by smoothly rounded contours with no sharp transitions. This type of pitting may arise in the course of maintenance work. The anti-corrosion coating is undamaged.	
Decision:		
	Pitted axles whose coating is nevertheless undamaged may remain on the vehicle.	
		OK

Pictorial representation:			
			

31 Mechanical damage – sharp edged circumferential fluting		Painted axles
Salient information:		
	Flutes are characterised by sharp edged circumferential sharp-edged transitions.	
	Mechanical damage to the base material in the form of fluting is inadmissible.	
Decision:		
	Check on the wagon why this damage could have occurred and repair accordingly.	
	Remove from service according	Case A
		X

Pictorial representation:

			
--	---	--	--



32 Mechanical damage – smooth edged circumferential grooves		Painted axles
Salient information:		
	Characterised by smooth transitions in the edges (GCU Appendix 9, 1.6.2). Pitting that arises during operation (caused e.g. by brake lever connectors dragging) involves damaged anti-corrosion coating	
Decision:		
	Check on the wagon why this damage could have occurred and repair accordingly.	
	Remove from service	Case B
	if there is damage to the base material > 1mm: (acc. GCU)	Case A
		X

Pictorial representation:





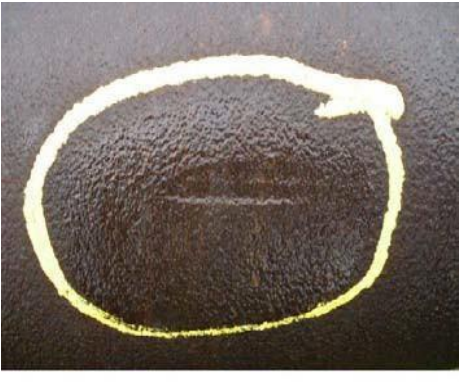

33 Mechanical damage – sharp edged notching		Painted axles
Salient information:		
	Sharp edged notches occur locally and are characterised by sharp-edged transitions.	
	Mechanical damage to the base material in the form of notching is inadmissible.	
Decision:		
	Remove from service (according to GCU criteria)	
		Case A
		X

Pictorial representation:			
			

34 Mechanical damage – cracks		Painted axles
Salient information:		
	Cracks occur locally on the shaft material (not on the painting) and are characterised and visible by fine lines.	
	Mechanical damage to the base material in the form of cracks is inadmissible.	
Decision:		
	Remove from service	
		Case A
		X

Pictorial representation:			
			

35 Surface damage – large and heavily corroded areas		Painted axles
Salient information:		
	Surface damage to base material in form of large and heavily corroded areas (old corrosion protection) is inadmissible.	
Decision:		
	Remove from service.	
		Case B
		X









Pictorial representation:			
			

36 Surface damage – single, deeply pitted corrosion scars		Painted axles
Salient information:		
	Surface damage to the base material in the form of marked, local corrosion scars (resulting e.g. from chemical effects) is inadmissible.	
Decision:		
	Remove from service.	Case B
		X

Pictorial representation:			
			

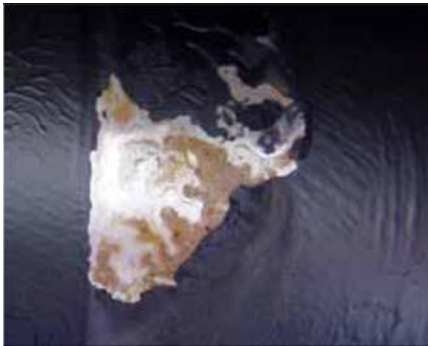



37 Coating damage – with or without corrosion		Painted axles
Salient information:		
	Minor lack of an anti-corrosion coating, whether corrosion is involved or not.	
Decision:		
	Leave in service acc. case C and/or repair the damage in situ on the wheelset.	
		Case C
		C

Pictorial representation:

CRITERIA FOR UNPAINTED AXLES

40 No defect - admissible surface appearance		Unpainted axles
Salient information:		
	There exist maintenance rules that do not require any anti-corrosion protection. Axles and wheels stay unpainted in such cases and show a thin and uniform layer of rust on their surfaces in service.	
Decision:		
	Deep corrosion is not accepted.	
	Leave in service wheelset "as new", "very good", "good" and "acceptable".	
		OK





Pictorial representation:			
As new	Very Good	Good	Acceptable
			

41 Mechanical damage – sharp edged circumferential fluting		Unpainted axles
Salient information:		
	Flutes are characterised by sharp edged circumferential sharp-edged transitions.	
	Mechanical damage to the base material in the form of fluting is inadmissible.	
Decision:		
	Check on the wagon why this damage could have occurred and repair accordingly.	
	Remove from service according	Case A
		X

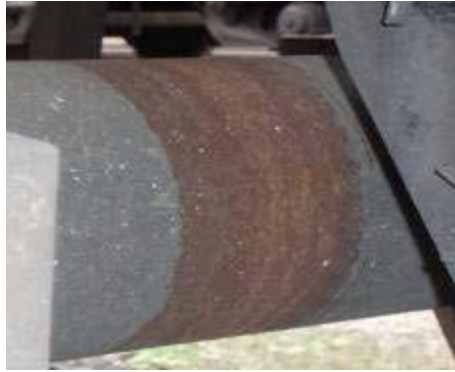

Pictorial representation:			
			

42 Mechanical damage – smooth edged circumferential grooves		Unpainted axles
Salient information:		
	Characterised by smooth transitions in the edges (GCU Appendix 9, 1.6.2). Pitting that arises during operation (caused e.g. by brake lever connectors dragging) involves damaged anti-corrosion coating	
Decision:		
	Check on the wagon why this damage could have occurred and repair accordingly.	
	Remove from service.	Case B
	if there is damage to the base material > 1mm: (acc. GCU)	Case A
		X

Pictorial representation:

			
--	---	--	--

43 Mechanical damage – sharp edged notching		Unpainted axles
Salient information:		
	Sharp edged notches occur locally and are characterised by sharp-edged transitions	
	Mechanical damage to the base material in the form of notching is inadmissible.	
Decision:		
	Remove from service (according to GCU criteria).	
		Case A
		X

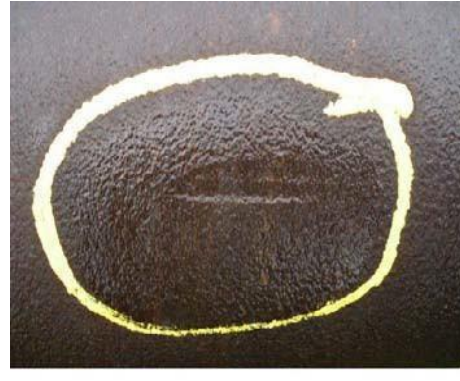
Pictorial representation:			
			

44 Mechanical damage – cracks		Unpainted axles
Salient information:		
	Cracks occur locally and are characterised and visible by fine lines.	
	Mechanical damage to the base material in the form of cracks is inadmissible.	
Decision:		
	Remove from service.	
		Case A
		X

Pictorial representation:			
			

45 Surface damage – large and heavily corroded areas		Unpainted axles
Salient information:		
	Surface damage to base material in form of large and heavily corroded areas (old corrosion protection) is inadmissible.	
Decision:		
	Remove from service.	
		Case B
		X

Pictorial representation:			
			

46 Surface damage – single, deeply pitted corrosion scars		Unpainted axles
Salient information:		
	Surface damage to the base material in the form of marked, local corrosion scars (resulting e.g. from chemical effects) is inadmissible.	
Decision:		
	Remove from service.	Case B
		X

Pictorial representation:			
			

ABUTMENT AREA

50 Abutment area		All axles
Situation:		
	Normally, the abutment area cannot be inspected sufficiently for wheelsets mounted in the wagon.	
Recommendation:		
Only if there is a clear indication on mechanical or corrosion damages		
	Take wheelset out.	Case A
		X
If not judgeable		
	Leave wheelset in service	
		OK

Pictorial representation:			
Not acceptable	Not judgeable		
			

B. Implementation Guide

The following pages represent the complete implementation guide.

**Implementation Guide for the
EUROPEAN VISUAL
INSPECTION CATALOGUE (EVIC)
FOR FREIGHT WAGON AXLES**

Table of contents

1. Definitions
2. Basics and preparing inspections
3. Conducting the Visual Inspections

1. Definitions

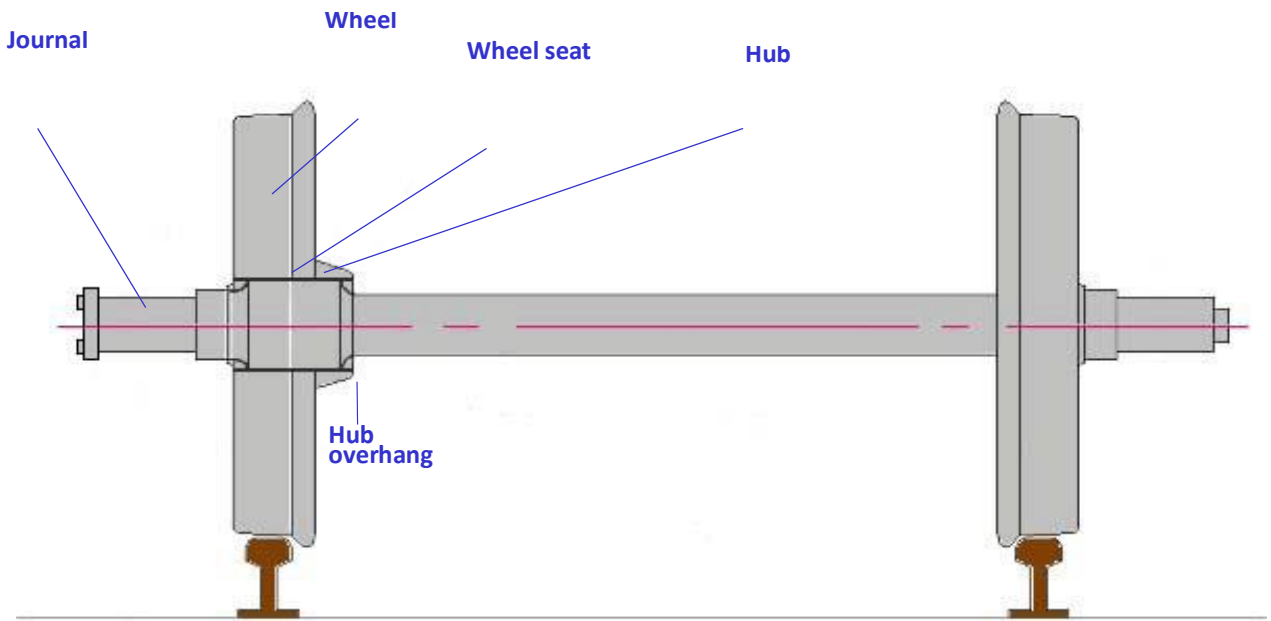

Wheelset

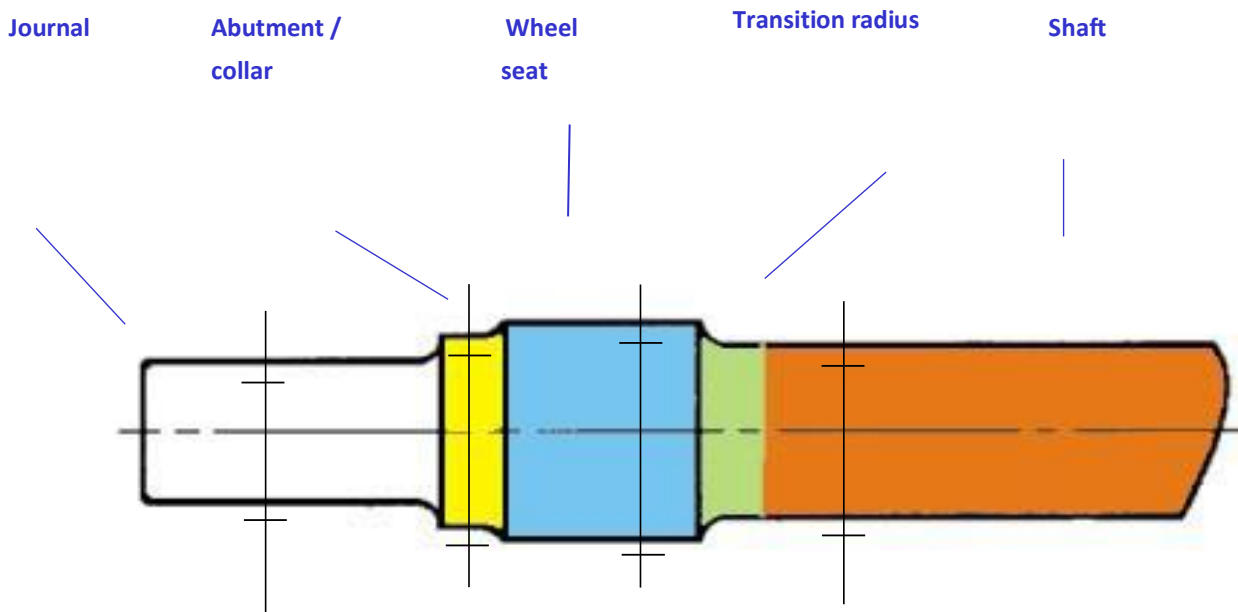

Axle

In the EVIC procedure instructions, the meaning of several expressions is as follows:

Replace = take the wheelset out of the wagon (and repair it in a suitably competent workshop, if possible)

Repair = repair the damage in situ (wheelset mounted) according to the relevant rules Remove from

service = replace or repair (in situ if possible) according to the criteria

2. Basics

2.1 Mandating and invoicing the EVIC inspection

The RU or its auxiliary must send the keeper the EVIC code for the operation performed on the wagon (as per Appendix 10, Annex 6) within one month of the wagon exiting the workshop.

In case of a replacement of “EVIC failed” wheelset, workshop and keeper need to communicate according to appendix 7 (Model H^R).

2.2 Staff qualifications

The inspections have to be conducted by staff qualified in application of this Visual Inspection Catalogue.

It is not necessary for the operatives conducting such visual inspections to be qualified as NDT visual inspectors on the basis of a standard.

The staff involved in this inspection should be trained one day for the correct use of this procedure.

It is under the responsibility of the workshop to update a list of trained workers for the use of the present procedure.

3 Conducting the visual inspection

3.1 Execution of the visual inspection

The Visual Inspection of the freight wagon’s axle shafts for damage to material and coating (if existing) is mandatory

- during light maintenance
- each time the wagon is in a workshop (not mobile team)

and if one of the following conditions is fulfilled:

- the wagon is on a pit or
- the wagon is lifted

In case of non-judgeable defects (not sufficiently detailed by the descriptions in the EVIC), the executor of the EVIC inspection must contact the keeper for further instructions.

A replacing wheelset for a sorted-out axle must be in an “EVIC ok” status.

The EVIC doesn't replace existing maintenance rules. First, existing maintenance rules must be applied, then the EVIC check. If an axle is sorted out with current maintenance rules, it is not necessary to apply the EVIC.

The visual inspection covers the complete area of the axle-shaft surface between the wheels. See special instructions for the abutment area in the EVIC.

The inspection area is to be examined for

- mechanical damage (fluting, pitting and notching, cracks)
- surface damage (areas eaten away, corrosion scars)
- coating damage (with and without corrosion) if coating system existing

Reference images in EVIC (typical damage features) are used for identifying inadmissible forms of damage.

It is not foreseen to clean the axle. In case of doubt, clean axle (locally) to allow examination

If natural light intensity is too poor, a supplementary white light source must be used in order to obtain an adequate visibility on the axle.

Axle shafts with inadmissible forms of damage are to be repaired according to the prescriptions, if possible. Otherwise, the axles must be replaced.

An example for an adequate position for the staff conducting the visual inspection is given in the figure below.

If the wheelset cannot rotate (if the wagon is not lifted up), the visibility of the full surface of the axle must be assured in a different way.

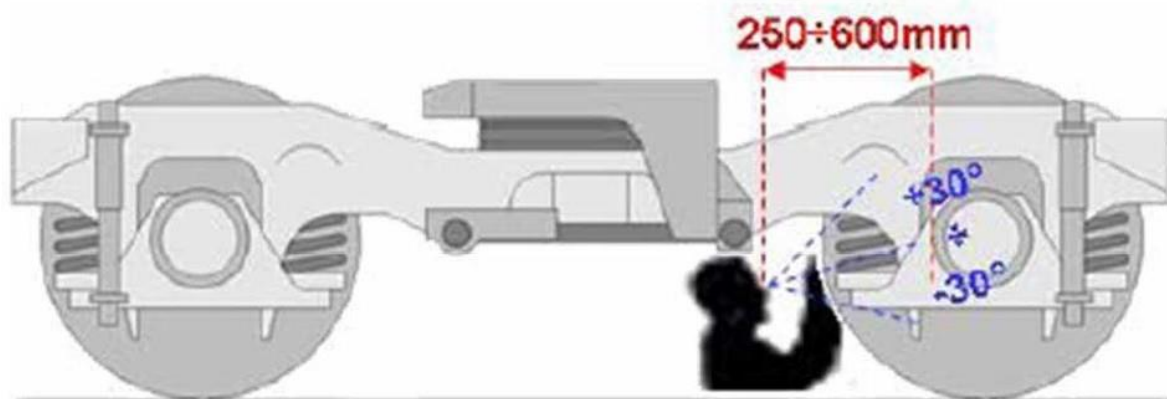

Figure 2 – Inspection angle and distance

3.2 Actions to be taken after inspection (cases)



The following cases describe the actions to be taken after a visual inspection of the axle:



- A Remove the wheelset from service without delay
- B Remove the wheelset from service after unloading the wagon and/or sending back to home workshop
- C Leave wheelset in service until the next revision/overhaul of the wagon or repair the damage in situ on the wheelset.
In the next revision/overhaul, the remove from service is mandatory.

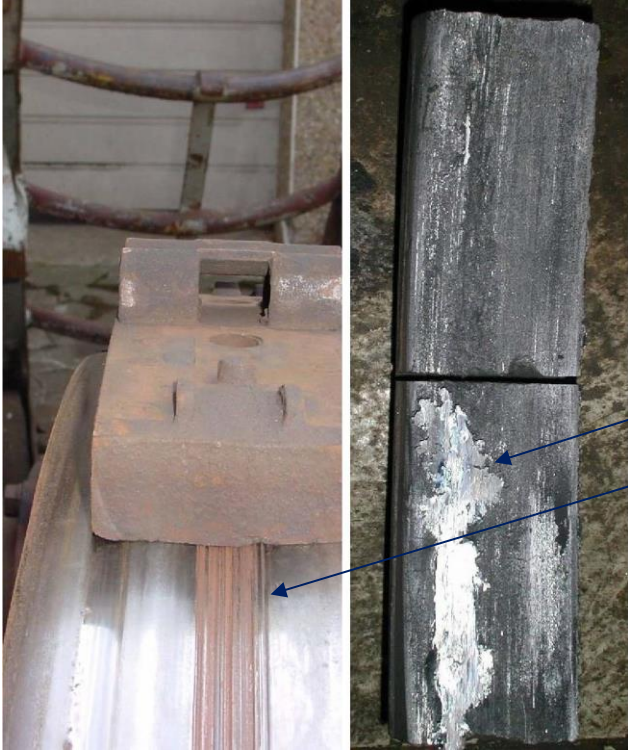

Remove from service = replace or repair (in situ if possible) according to the criteria.

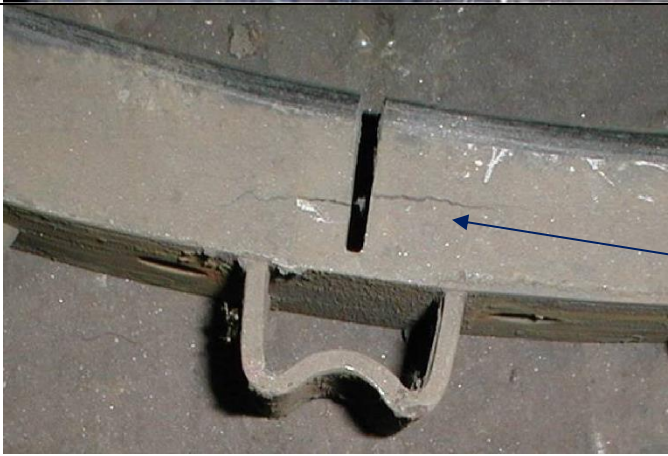

Appendix 10, Annex 4

COMPOSITE BRAKE BLOCKS: WHEN TO REPLACE AND NOT TO REPLACE

Picture	Description, limit value	Action to be taken
	<p>Picture 1: Most of tread displays hollowing (e.g. grooves) and/or shiny metallic marks</p>	<p>Replace</p> <p><u>Note:</u> Check wheel tread in accordance with Chapter A 1.6.1</p>
	<p>Picture 2: Friction material has become detached from plate over a length of > 25 mm</p>	<p>Replace</p>

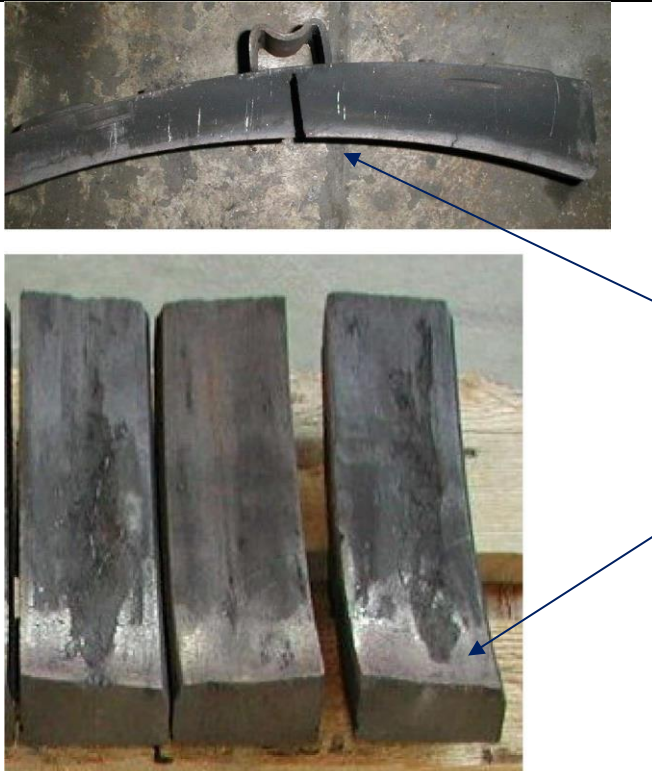
Picture	Description, limit value	Action to be taken
	<p>Picture 3: Crack on the expansion joint (designated breaking-point)</p> <p>Incipient cracking or crack on brake block</p>	<p>Do not replace</p>
	<p>Picture 4: Incipient cracking of > 25 mm parallel to the wheel circumference</p>	<p>Replace</p>
	<p>Picture 5: Significant difference in the block's thickness at the top and bottom ends (one-sided wear). Smallest thickness is below 10 mm</p>	<p>Replace</p>

Picture	Description, limit value	Action to be taken
	<p>Picture 6: Incipient radial cracking in friction material</p>	<p>Do not replace</p>
	<p>Picture 7: Radial crack in the brake block from the friction surface to the plate: the brake block displays a radial crack from the friction surface to the plate/edge of the plate, not located on the expansion joint (designated breaking- point).</p>	<p>Replace</p>
	<p>Picture 8: “White film” on surface of contact area and to a depth of 10 mm or significant shelling on the contact surface and heavy carbonisation</p>	<p>Do not replace</p> <p><u>Note:</u> Check wheelset in accordance with Chapter A 1.18</p>

Picture	Description, limit value	Action to be taken
	<p>Picture 9: Branched thermal crack pattern, mainly axial (not thermal cracks, cf. vitrification) and carbonisation</p>	<p>Do not replace</p>
<p>No figure</p>	<p>Crumbling (without carbonisation)</p>	<p>Replace</p>
	<p>Picture 10: Damage to brake block due to metal build-up on the wheelset or wheel flat</p>	<p>Replace</p> <p><u>Note:</u> Check wheel tread in accordance with Chapter A 1.6.1</p>

Appendix 10, Annex 5

VERIFICATION AND HANDLING OF GREASE/OIL DEPOSITS ON WHEELS AND AXLE BOXES

Concerns wagons withdrawn from service due to loss of lubricant or on which a lubricant leak is recorded in the context of an axle/running gear inspection (e.g. EVIC).

General remark:

The procedure described hereafter must only be applied if no “hot box” or “temperature” notification has been issued by the hot box detection system!

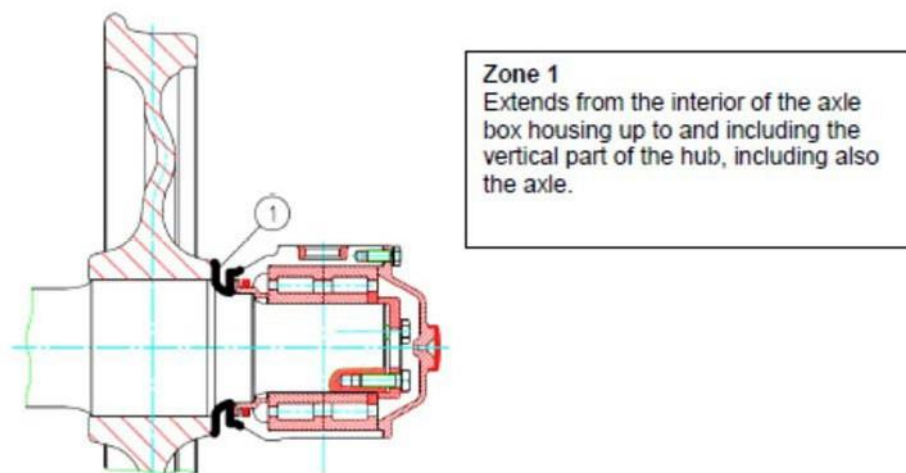

Lubricant on the axle box housing – zone 1

Axles with grease or oil in “zone 1” may remain under the wagon subject to the following measures being taken in the locations concerned:

Measures to be taken:

- The wagon’s keeper must be informed. It is the keeper’s job to provide instructions to apply a marking to the axle or to enter it in the axle database, and to decide whether the axle may remain under the wagon or whether it should be replaced.
- If the keeper says the axle can remain under the wagon, the excess grease/oil is to be wiped away.

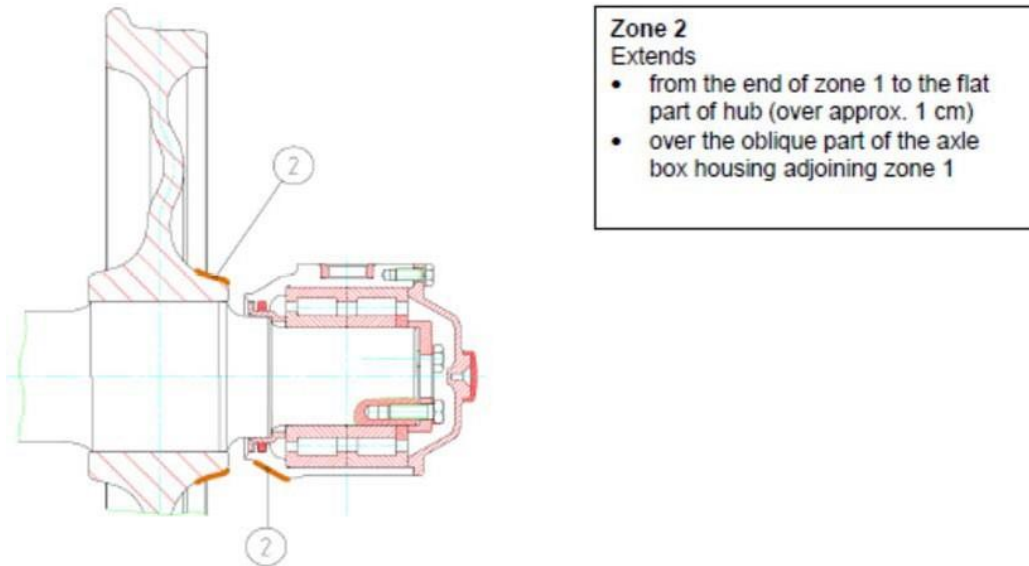

Lubricant on the axle box housing – zone 2

Axles with grease or oil in “zone 2” may remain under the wagon subject to the following measures being taken in the locations concerned:

Measures to be taken:

- The wagon’s keeper must be informed. It is the keeper’s job to provide instructions to apply a marking to the axle or to enter it in the axle database, and to decide whether the axle may remain under the wagon or whether it should be replaced.
- If the keeper says the axle can remain under the wagon, the excess grease/oil is to be wiped away.

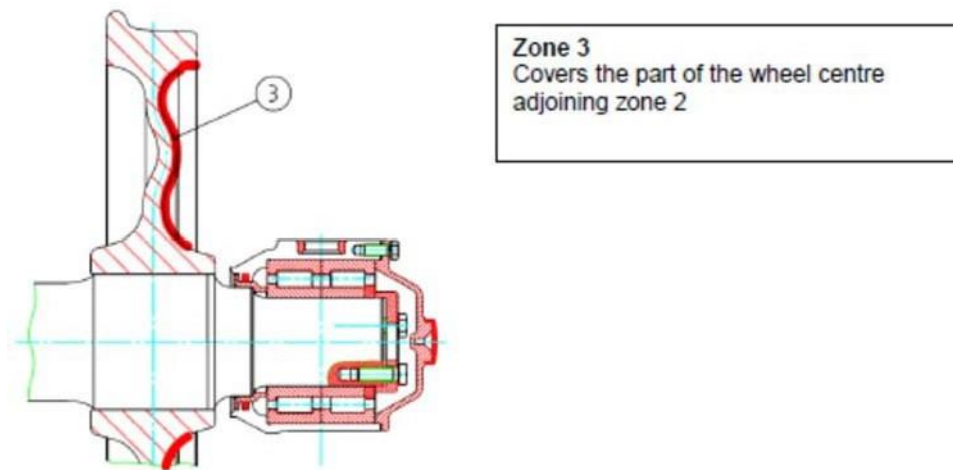

Projections of oil/grease on the axle box housing – zone 3

For axles with lubricant projections on the wheel centre in “zone 3”, **IF THESE PROJECTIONS DO NOT EMANATE FROM the hub or the axle box but begin beyond the axle box housing,**

or

if traces of lubricant, emanating radially from the axle box housing, are observed scattered irregularly across “zone 3”, the axles may remain under the wagon subject to the following measures being taken in the locations concerned:

Measures to be taken:

- The wagon’s keeper must be informed. It is the keeper’s job to provide instructions to apply a marking to the axle or to enter it in the axle database, and to decide whether the axle may remain under the wagon or whether it should be replaced.
- If the keeper says the axle can remain under the wagon, the excess grease/oil is to be wiped away.

Oil/grease leakage distributed regularly across the whole wheel centre circumference – zone 3

If the lubricant emanates radially from the axle box housing and spreads in a uniform manner across the wheel body, wheel centre or intersection between the wheel body and tyred rim, the axle must be removed and replaced, applying Label H^R.

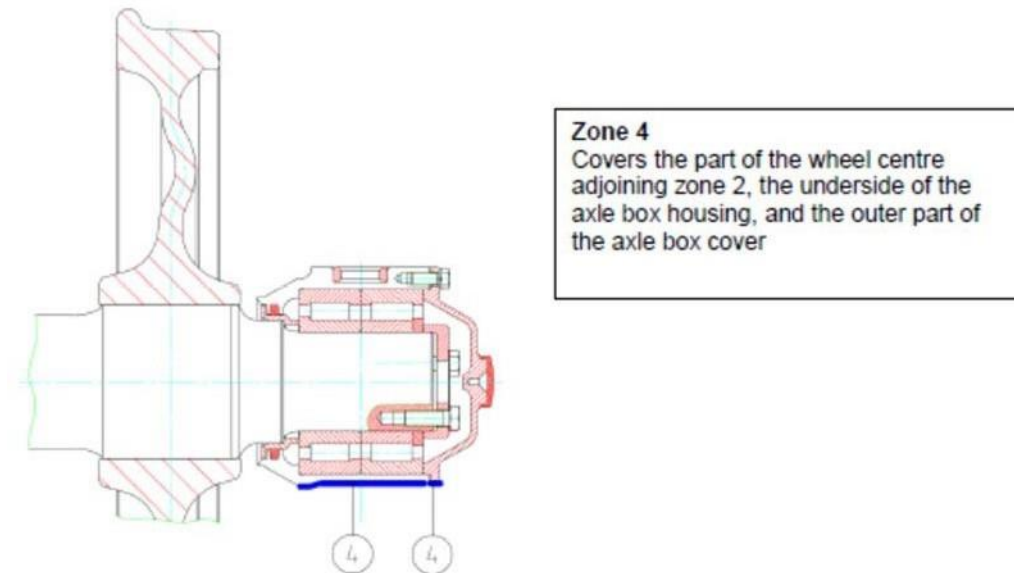

Oil/grease leakage on the bottom of the axle box housing – zone 4

If lubricant is observed in “zone 4”, the location from where the grease/oil is leaking is to be identified. The procedure to be applied varies depending on the origin of the problem:

- a. the grease/oil emanates from zones 1 and 2, within the axle box housing, and is leaking underneath the axle box housing;
- b. there are traces of grease/oil on the axle box cover, running under the axle box housing;
- c. the axle box housing is cracked/broken.

Measures to be taken if points a or b apply:

- The wagon’s keeper must be informed. It is the keeper’s job to provide instructions to apply a marking to the axle or to enter it in the axle database, and to decide whether the axle may remain under the wagon or whether it should be replaced.
- If the keeper says the axle can remain under the wagon, the excess grease/oil is to be wiped away.

Measures to be taken if point c applies:

- Remove the axle from the wagon concerned and replace it, applying Label H^R.

Appendix 10, Annex 6

CODING OF INTERVENTIONS

This list comprises the interventions possible under the GCU. They must be communicated to the keeper by the RU or its auxiliary performing the work, using the coding given in column 2. All codes of the interventions are to be communicated. Codes shall be indicated on the invoice and/or sent separately to the keeper. The wagon number, workshop name and date of entry to/exit from the workshop must be at least indicated as basic data.

Any additional information necessary and measurement values may be communicated with the codes or in a separate list. All reports mentioned shall be sent immediately.

Structure of the list:

Column 1, GCU intervention code: the intervention codes shall be sent to the keeper. Example meaning of code CU12345

CU:	Indicates that the code belongs to the GCU, Appendix 10	
1:	Section of the GCU, Appendix 9 or Appendix 10	
234:	Sequence number	
5:	Substance of intervention	0: inspection 1: repair, reset (without welding) 2: exchange 3: weld

Column 2, action: description of action. May, if so desired, be sent with intervention code.

Column 3, other vital information: the measurement values indicated, position-related data, and any reports shall be communicated to the keeper.

Column 4, inspection as per Appendix 9: intervention corresponds to damage as described in Appendix 9 to the GCU.

Column 5, inspection as per Appendix 10: intervention corresponds to damage as described in Appendix 10 to the GCU.

GCU intervention code	Intervention(s)	Any additional information necessary	Technical Inspection as per Appendix 9	Rules as per Appendix 10
CU10010	Measure wheelset in accordance with points in section A1	axle number, value, measuring point	1.1.1, 1.3.1, 1.4, 1.7.1	1.1-1.6, 1.9, 1.18, 1.19
CU10012	Replace wheelset if values measured not within tolerances	axle number, form H ^R , value, measuring points		1.1-1.6, 1.9, 1.18, 1.19
CU10020	Visually inspect wheelset	axle number,	1.2.1, 1.3.2, 1.6.1, 1.6.3, 1.8.2	1.6-1.8, 1.10-1.15.1
CU10022	Replace wheelset following visual inspection	axle number, form H ^R	1.5	1.6-1.8, 1.10-1.15.1
CU10150	Check against EVIC			1.15.2
CU10152	Replace wheelset following EVIC inspection	Axle number, Form H ^R		1.15.2
CU10160	Check that tyre is not loose		1.1.2-1.1.6	1.16
CU10162	Replace wheelset following check that tyre has not come loose	axle number, form H ^R		1.16
CU10170	Measure wheelset in accordance with 1.17 (three-point measurement)	axle number, values		1.17
CU10172	Replace wheelset if values measured fall outside 1.17 tolerances	axle number, form H ^R		1.17
CU10180	Test for overheating			1.18
CU10181	Thermally overloaded thermostable wheelsets without wheelset replacement	axle number		1.18
CU10200	Check there is no loss of grease/oil	axle number, position of axle box	1.8.1	1.20
CU10201	Wipe clean any lubricant loss as per Annex 5	axle number, position of axle box		1.20
CU10281	Reprofile monobloc wheel	axle number, value, measurement report		1.28
CU10322	Replace wheelset following hot box	axle number, form H ^R	1.2.2.2, 1.8.3	1.32
CU20010	Visually inspect leaf-spring suspension	position of axle box,	2.1.1-2.1.4, 2.1.6	2.1, 2.2, 2.4, 2.7
CU20012	Replace leaf-spring suspension spring	position of axle box, form H, indicate reason for change	2.1.1-2.1.4, 2.1.6	2.1, 2.2, 2.4, 2.7
CU20030	Check helical springs	position of axle box,	2.5.1, 2.5.2.x	2.3, 4.20-4.23
CU20032	Replace helical spring	position of axle box, form H, indicate reason for change		2.3, 4.20-4.23
CU20050	Check distance between spring buckle and fixed part of bogie frame or wagon	position of axle box,	2.1.5, 2.5.6	2.5
CU20051	Rectify distance between spring buckle and fixed part of bogie frame or wagon	position of axle box,	2.1.5, 2.5.6	2.5
CU20060	Check for contact marks between spring buckle and fixed part of bogie frame or wagon	position of axle box,	2.4.4, 2.5.6	2.6
CU20061	Rectify causes and paint any contact marks between spring buckle and fixed part of bogie frame or wagon	position of axle box, detail activities	2.4.4, 2.5.6	2.6
CU20080	Check elements composing the elastic suspension	position of axle box,	2.4.2- 2.4.4	2.8
CU20082	Replace elements composing the elastic suspension	position of axle box, indicate reason for change	2.4.2- 2.4.4	2.8
CU20092	Replace suspension spring shaft	position of axle box, indicate reason for change	2.4.3	2.8
CU30030	Check main brake pipe			3.3
CU30040	Check disc brake indicator			3.4
CU30050	Check brake rigging and mechanical parts		3.1.1	3.1-3.2, 3.6, 3.13
CU30060	Check safety stirrups		3.1.2	3.5
CU30061	Right/straighten safety stirrup		3.1.2	3.5

GCU intervention code	Intervention(s)	Any additional information necessary	Technical Inspection as per Appendix 9	Rules as per Appendix 10
CU30062	Replace safety stirrup		3.1.2	3.5
CU30070	Check brake blocks		3.2	3.6-3.8
CU30072	Replace brake blocks		3.2	3.6-3.8
CU30100	Check brake hoses		3.3.2	3.9-3.10
CU30102	Replace brake hoses		3.3.2	3.9-3.10, 3.17
CU30110	Check height of brake hoses relative to rail			3.11
CU30111	Rectify height of brake hoses relative to rail			3.11
CU30120	Check cut-off cock		3.3.5	3.12
CU30121	Replace cut-off cock		3.3.5	3.12
CU30131	Remove or secure damaged or detached brake parts	indicate which parts have been removed or secured		3.13
CU30150	Check handbrake		3.5	3.15
CU30151	Repair handbrake		3.5.1	3.15
CU30190	Perform brake test as per UIC 543-1	brake test report		3.19
CU30200	Inspect brake release pull		3.1.5	3.20
CU30202	Replace brake release pull		3.1.5	3.20
CU30210	Check brake performance after replacing brake blocks and/or wheelsets			1.37, 3.21
CU40010	Check wagon underframe		4.1.1, 4.1.2	4.1
CU40020	Check flanges of solebars, headstocks and intermediate cross-bars subject to stress from the coupler		4.1.1, 4.1.2	4.2
CU40030	Check welding on wagon underframe		4.1.1, 4.1.2	4.3
CU40033	Repair wagon underframe by welding	indication as per EN 15085- 2	4.1.1, 4.1.2	4.3
CU40060	Check spark arrestor plates		3.4	4.6, 4.7
CU40061	Repair spark arrestor plate	position of axle box	3.4	4.6, 4.7
CU40062	Replace spark arrestor plate	position of axle box	3.4	4.6, 4.7
CU40080	Check axle guard and tie		4.2.x, 4.3.1, 4.4.x	4.8-4.10
CU40081	Repair axle guard		4.2.x, 4.3.1	4.8-4.10
CU40082	Replace axle guard		4.2.x, 4.3.1	4.8-4.10
CU40102	Replace axle guard tie	position of axle box	4.2.x, 4.3.1	4.8-4.10
CU40110	Check suspension spring brackets		4.5.1	4.11
CU40111	Repair suspension spring brackets		4.5.1	4.11
CU40112	Replace suspension spring brackets	position of axle box	4.5.1	4.11
CU40120	Check bogies		4.7.x	4.12-4.15
CU40130	Check welds on bogie frames	bogie number or position of axle box	4.7.x	4.12-4.15
CU40133	Repair bogie frame by welding	bogie number or position of axle box	4.7.x	4.12-4.15
CU40140	Check side bearer fastenings		4.8.3	4.14
CU40141	Restore side bearer fastenings to working order		4.8.3	4.14
CU40142	Replace side bearer parts		4.8.3	4.14
CU40160	Check bogie centre casting	bogie number or position of axle box	4.6.1	4.16
CU40162	Replace bogie centre casting	bogie number or position of axle box	4.6.1	4.16

GCU intervention code	Intervention(s)	Any additional information necessary	Technical Inspection as per Appendix 9	Rules as per Appendix 10
CU40170	Check kingpin	bogie number or position of axle box	4.6.1	4.17
CU40172	Replace kingpin	bogie number or position of axle box	4.6.1	4.17
CU40180	Check axle guard guiding surface		4.4.x	4.18
CU40183	Weld axle guard guiding surface	position of axle box	4.4.x	4.18
CU40190	Check earthing braid		4.6.2.x	4.19
CU40191	Attach earthing braid	bogie number or axle box position number	4.6.2.x	4.19
CU40192	Replace earthing braid	bogie number or position of axle box	4.6.2.x	4.19
CU40322	Replace any rivets, screws or bolts which are loose or missing from the axle guard securing	position of axle box		4.32
CU40331	Clean contact surface of the suspension shock absorber	position of axle box		4.33
CU40343	Weld wear plate onto bogie	bogie number or position of axle box		4.34
CU50010	Measure buffing height	height per buffer	5.1.2	5.1
CU50030	Check buffers, "starred points"		5.1.1, 5.2.x, 5.3.x, 5.4.x, 5.5.x	5.3, 5.7, 5.8, 5.9
CU50032	Replace buffer fastening bolt		5.4.4.x	5.3
CU50040	Check buffers: fastening, spring, casing		5.1.1, 5.2.x, 5.3.x, 5.4.x, 5.5.x	5.4, 5.5, 5.6
CU50042	Replace buffers at one end			5.23
CU50081	Lubricate buffer plates		5.2.3.1	5.8
CU50091	Grind buffer plates following detection of grooving		5.2.3.2	5.9.1, 5.9.2
CU50110	Check draw hook and screw coupler		5.6.x	5.11, 5.12, 5.13, 5.14, 5.19
CU50111	Rectify height of screw coupler relative to rail		5.6.3	5.11
CU50132	Replace screw coupler			5.13
CU50141	Lubricate screw coupling			5.14.1
CU50142	Replace draw hook		5.7.1.x	5.13
CU50150	Check draw bar		5.8.1	5.15
CU50170	Check traction		5.6.2	5.17, 5.18
CU50172	Replace traction		5.6.2	5.17, 5.18
CU50200	Check screw coupler dummy hook		5.6.2	5.20
CU50201	Right/straighten screw coupler dummy hook		5.6.2	5.20
CU50202	Replace screw coupler dummy hook		5.6.2	5.20
CU50213	Repair draw bar temporarily by welding			5.21
CU50220	Check shock absorber		5.9.1	5.22
CU50221	Repair shock absorber		5.9.1	5.22
CU50252	Replace damaged or distorted anti-crash device		5.5.2	5.26
CU50262	Replace buffer fitted with damaged or distorted anti-crash device with standard buffer		5.5.2	5.26
CU60020	Check wagon body		6.1.3.x, 6.1.4.x, 6.1.7.9	6.1,6.2
CU60021	Repair wagon body		6.1.3.x, 6.1.4.x	6.2
CU60022	Repair wagon body following gauge-fouling		6.1.3.x, 6.1.4.x	6.2
CU60030	Check heating pipes and other connections			6.3
CU60031	Rectify minimum height relative to the rail of the heating pipes and other connections			6.3

GCU intervention code	Intervention(s)	Any additional information necessary	Technical Inspection as per Appendix 9	Rules as per Appendix 10
CU60040	Check moving parts and the devices used to control them			6.4
CU60041	Restore moving parts and the devices used to control them to working order			6.4
CU60050	Check floor		6.1.5.x	6.5
CU60051	Repair floor		6.1.5.x	6.5
CU60060	Check sliding doors and collapsible side walls		6.1.6.x	6.6
CU60061	Restore sliding doors and collapsible side walls to working order		6.1.6.x	6.6
CU60070	Check door locking		6.1.6.x	6.7
CU60071	Restore door locking to working order		6.1.6.x	6.7
CU60080	Check door leak-tightness		6.1.6.x	6.8
CU60081	Restore door leak-tightness to working order		6.1.6.x	6.8
CU60090	Check guiding and locking systems		6.1.6.x	6.9
CU60091	Restore guiding and locking systems to working order		6.1.6.x	6.9
CU60092	Replace guiding and locking systems		6.1.6.x	6.9
CU60100	Check steps and handrails		6.1.7.1-6.1.7.4	6.10, 6.11, 6.12
CU60101	Right/straighten steps and handrails		6.1.7.1-6.1.7.4	6.10, 6.11, 6.12
CU60102	Replace steps and handrails	indicate parts replaced	6.1.7.1-6.1.7.4	6.10, 6.11, 6.12
CU60130	Check label-holder, marking plate, etc.		6.1.7.5,6.1.7.6	6.13
CU60131	Repair label-holder, marking plate, folding board		6.1.7.5,6.1.7.6	6.13
CU60132	Replace label-holder, marking plate, folding board	indicate parts replaced	6.1.7.5,6.1.7.6	6.13
CU60140	Check markings as per Appendix 11		6.1.x, 6.2.x	6.14
CU60141	Render markings compliant		6.1.x, 6.2.x	6.14
CU60150	Check ventilation flaps		6.2.1.x	6.15
CU60151	Repair ventilation flaps		6.2.1.x	6.15
CU60152	Replace ventilation flaps		6.2.1.x	6.15
CU60160	Check control gear and shutter retaining brackets		6.2.2.x	6.16
CU60161	Repair control gear and shutter retaining brackets		6.2.2.x	6.16
CU60162	Replace control gear and shutter retaining brackets		6.2.2.x	6.16
CU60170	Check roof cover and guttering		6.2.3	6.17
CU60171	Repair roof cover and guttering		6.2.3	6.17
CU60180	Check opening roof		6.2.4.x	6.18
CU60181	Repair opening roof		6.2.4.x	6.18
CU60190	Check roof hatches		6.2.4.x	6.19
CU60191	Restore roof hatches to working order			6.19
CU60200	Check side door locking		6.3.1.x	6.20
CU60201	Repair side door locking		6.3.1.x	6.20
CU60210	Check end flap/board locking		6.3.1.x, 6.3.2.x	6.21
CU60211	Repair end flap/board locking		6.3.1.x, 6.3.2.x	6.21
CU60222	Replace closing end parts			6.22
CU60230	Check cantrail		6.3.3.x	6.23
CU60231	Repair cantrail		6.3.3.x	6.23
CU60240	Check drop sides		6.4.1.x	6.24
CU60241	Restore drop side to working order		6.4.1.x	6.24
CU60250	Check hinges, pins and securing devices of drop sides		6.4.2.x	
CU60251	Repair hinges, pins and securing device of drop sides		6.4.2.x	6.25
CU60260	Check stanchions		6.4.3.x	6.26, 6.46

GCU intervention code	Intervention(s)	Any additional information necessary	Technical Inspection as per Appendix 9	Rules as per Appendix 10
CU60261	Restore stanchions to working order		6.4.3.x	6.26, 6.46
CU60262	Replace stanchions		6.4.3.x	6.26, 6.46
CU60270	Check folding bolsters		6.4.4.x	6.27
CU60271	Repair folding bolsters		6.4.4.x	6.27
CU60280	Check deformation on tank		6.5.1.x, 6.5.2.x	6.28
CU60285	Check tank, "starred points"		6.5.1.x, 6.5.2.x, 6.5.3.x, 6.5.5.3, 6.5.5.6, 6.5.5.7, 6.5.5.8, 6.5.5.9, 6.5.5.10	6.28-6.32, 6.34, 6.35, 6.37
CU60310	Check ladders, platforms and guard rails			6.31
CU60311	Repair ladders, platforms and guard rails			6.31
CU60320	Check tank cladding, sun-roofs and insulation		6.5.3.x	6.32
CU60321	Repair tank cladding, sun-roofs and insulation		6.5.3.x	6.32
CU60330	Check that tank and their filling and emptying devices do not leak		6.5.5.x	6.33
CU60331	Repair any leaks from tanks and their filling and emptying devices		6.5.5.1	6.33
CU60342	Replace screw cap		6.5.5.3	6.34
CU60350	Check blind flange		6.5.5.6, 6.5.5.7, 6.5.5.8, 6.5.5.9	6.35
CU60351	Tighten blind flange		6.5.5.6, 6.5.5.7, 6.5.5.8, 6.5.5.9	6.35
CU60352	Replace blind flange		6.5.5.6, 6.5.5.7, 6.5.5.8, 6.5.5.9	6.35
CU60360	Check emergency control screw		6.5.5.12	6.36
CU60370	Check indicator on emptying valve		6.5.5.10	6.37
CU60380	Check dome hatch		6.5.6.2	6.38
CU60390	Check mechanical sheeting and locking mechanism		6.6.1	6.39
CU60391	Restore mechanical sheeting and locking mechanism to working order		6.6.1	6.39
CU60400	Check hood locking system		6.6.2.x	6.40
CU60401	Restore hood locking system to working order		6.6.2.x	6.40
CU60410	Check moving headstock		6.6.3.1, 6.6.3.2	6.41
CU60411	Restore moving headstock to working order		6.6.3.1, 6.6.3.2	6.41
CU60420	Check seating device, seating device bolts, securing chains and chain eyes		6.6.3.3 6.7.1.1 6.7.1.2 6.7.2	6.42
CU60421	Restore seating device, seating device bolts, securing chains and chain eyes to working order		6.6.3.3 6.7.1.1 6.7.1.2 6.7.2	6.42
CU60430	Check swivel frame (ACTS)		6.6.4.1, 6.6.4.5, 6.6.4.6	6.43
CU60431	Restore swivel frame (ACTS) to working order		6.6.4.1, 6.6.4.5, 6.6.4.6	6.43
CU60440	Check snap locks (ACTS)		6.6.4.2	6.44
CU60441	Restore snap locks (ACTS) to working order		6.6.4.2	6.44
CU60450	Check central lock (ACTS)		6.6.4.4	6.45
CU60451	Restore central lock (ACTS) to working order		6.6.4.4	6.45
CU60470	Check end boards and crossing gangways		6.6.5.3	6.47

GCU intervention code	Intervention(s)	Any additional information necessary	Technical Inspection as per Appendix 9	Rules as per Appendix 10
CU60471	Repair end boards and crossing gangways		6.6.5.3	6.47
CU60472	Replace end boards and crossing gangways		6.6.5.3	6.47
CU60480	Check upper loading deck and indicator device		6.6.5.4, 6.6.5.5, 6.6.5.6, 6.6.5.7	6.48
CU60500	Check valves and hatches		6.6.6.1, 6.6.6.2	6.50
CU60501	Repair valves and hatches		6.6.6.1, 6.6.6.2	6.50
CU60510	Check locking and discharging system			6.51
CU60511	Repair locking and discharging system			6.51
CU61010	Check locking of container spigots			
CU61011	Repair container spigot locking system			
CU61012	Replace container spigot locking system			
CU61020	Check dividing wall			
CU61021	Repair dividing wall			
CU61030	Check securing systems (e.g. hoops)			
CU61031	Repair securing systems (e.g. hoops)			
CU61040	Check detachable accessories		6.1.7.7, 6.1.7.8	
CU61041	Replace detachable accessory with a part from company stocks		6.1.7.7, 6.1.7.8	
CU63900	Mechanical sheeting inspection		6.6.1.2, 6.6.1.3	6.39.1
CU63901	Repair mechanical sheeting		6.6.1.2, 6.6.1.3	6.39.2
CU77271	Removal and disposal of loading residues	photo of loading residues	7.2.7	0 Principle

Definition of terms:

Check	Act of assessing, verifying or measuring, and of judging and defining corrective measures
Position of axle box	Position of the axle as indicated by the marking on the wagon. If there is no such marking, count from one end (choose which) of the wagon.

APPENDIX 11
TO THE GENERAL CONTRACT OF USE FOR WAGONS

INSCRIPTIONS AND SIGNS ON WAGONS

Contents

Point	Subject	Page
1	Introduction – General provisions	4
2.1	Wagon number, country of registration, keeper, type	5
2.2	Derogation plate	7
2.3	Maintenance plate	9
2.4	Signs indicating load limits	10
2.5	Sign indicating carrying capacity	12
2.6	Signs indicating concentrated loads distributed over supporting surfaces of different lengths	13
2.7	Sign indicating the capacity of tank wagons and cask wagons	17
2.8	Signs indicating the length of load and floor space	18
2.9	Sign indicating the distance between end axles and bogie centres	19
2.10	Sign indicating spark arrestor plates	19
2.11	Additional signs for wagons authorised to run in Great Britain	21
2.12	Sign for ferry ramp angle	22
2.13	Sign for removable wagon accessories	23
2.14	Sign for the inside of wagons: "Do not use nails or wire staples"	25
2.15	Marking for wagons with special fittings (wagons with automatic discharge facility, opening roof, etc.)	25
2.16	Signs for wagons built for running between countries with different track gauges	26
2.17	Sign for bogies fitted with gauge-adjustable axles, nominal gauge 1435 mm (automatic gauge changeover facility according to the UIC leaflet 510-4)	26
2.18	Sign for bogies fitted with gauge-adjustable axles, nominal gauge 1520 mm (automatic gauge changeover facility according to the UIC leaflet 510-4)	27
2.19	Additional signs for wagons accepted for running in Spain and Portugal	28
2.20	Approval plate	29
2.21	Marking of vehicle gauge on wagon	29
3.1	Sign for height of the loading plane for container wagons in unladen state	30
3.2	Signs for combined transport wagons in accordance with UIC leaflet 50571-4	31
4.1	Sign for length over buffers	38
4.2	Signs for tare and braked weight	39
4.3	Signs to indicate the changeover device for air brakes - Marking of the braked weight on wagons. Brake type abbreviations	41
4.4	Signs for wagons fitted with composite brake blocks	48
4.5	Sign for wagons fitted with disc brakes	49
5.1	Sign for wagons not authorised to negotiate all shunting humps	50
5.2	Sign for bogie wagons with a distance of over 14.0 m between inner axles and accepted on shunting humps	50
5.3	Sign for wagons that are not authorised to pass through retarders or other shunting and stopping devices in active mode	51
5.4	Sign for wagons not to be loose-shunted	51
5.5	Sign for wagons that must not be fly- or gravity-shunted	52
5.6	Sign for fly and hump shunting not permitted for containers or loaded pocket wagons	52
5.7	Marking for wagons fitted with anti-crash components	53

Point	Subject	Page
5.8	Marking for wagons fitted with long-stroke shock absorbers (schock absorber fitting)	53
5.9	Marking for wagons fitted with projecting tow hooks	54
5.10	Sign for permanently-coupled wagon units	54
5.11	Sign for bogie wagons only able to negotiate curves with a radius greater than 35 m	55
5.12	Signs indicating wagons fitted with a train line	55
5.13	Sign for wagons fitted with the automatic coupler	56
5.14	Sign for derailment detectors	56
5.15	Sign for strengthened screw coupling	57
6.1	Sign for wheels able to withstand high thermal stresses	59
6.2	Marking of tyred wheels	59
6.3	Sign for ventilation pipes	60
6.4	Sign for tank wagon tests, coding of tanks and special regulations	60
7.1	Sign indicating points for lifting the wagon body in the workshop	61
7.2	Sign for lifting at 4 points with or without running gear	61
7.3	Sign for lifting or re-railing with or without running gear at one end only or close to the end	62
7.4	Sign for the replacement of springs	62
7.5	Sign Wheel tyre inspection	63
7.6	Sign for inspection periods for temperature controlled units	64
7.7	Sign for the protection of the inner lining of tank wagons	64
7.8	Signs for privately-owned wagons, unified wagons, standard wagons	65
7.9	Sign for the spare parts	66
8.1	Signs for high voltage warning sign	67

1 Introduction – General provisions

- 1.1 This appendix describes the inscriptions and signs to be affixed to freight wagons (referred to hereafter as wagons) and indicates where they should be positioned. The inscriptions and signs have been grouped together according to certain processes or operations: the loading and provision of wagons, combined transport (CT), train preparation, shunting, technical inspections, workshops and key warning signs – but are not exclusively assigned to a specific process, specialist department or user.
- 1.2 Wagons must carry inscriptions and signs in specific places. They should be affixed in the language of the wagon keeper, using Latin characters and Arabic numerals. The inscriptions and signs must always be clearly visible. They should be placed on the side walls, if possible 1600 mm above rail level (height of the middle of the sign). For wagons without side walls, the inscriptions shall be carried on special boards. For the provisions regarding the mark plates on the tank wagons see **UIC leaflet 573**. No other meanings may be assigned to the inscriptions and signs.
- 1.2 Wagons on which the markings and signs are missing or illegible shall be dealt with in accordance with Annexes 9 and 10.
- 1.4 Inscriptions and signs other than those listed in this annex must be placed on parts of the wagon not occupied by these inscriptions. The lower left-hand corner of the side walls is reserved for affixing labels, with the exception of K and M labels.

2.1 Wagon number, country of registration, keeper, type

The markings shall be made on the side of the wagon as follows (examples):

31 RIV 80 <u>D</u> -DB 0691 235-2 Tanoos	32 RIV 80 <u>D</u> -BASF 7369 553-4 Zcs	33 RIV 84 <u>NL</u> -ACTS 4796 100-8 Slpss	43 87 <u>E</u> 4273 361-3 Laeks
---	--	---	--

or

33 TEN 84 <u>NL</u> -ACTS 4796 100-8 Slpss	87 TEN 82 <u>D</u> -CFLCA 4978 006-4 Sdmrs	G1	CW
---	---	----	----

or

37 TEN 82 <u>L</u> -CFLCA 4992 009-1 Sdggmrss	81 TEN 82 <u>L</u> -CFLCA 3513 156-7 Rbnpss	GE	Derogation plate
--	--	----	------------------

When the wagon body does not provide sufficient surface area for this layout (flat wagons in particular) the markings shall be made as follows (example):

01	87	3320 644-7
RIV	<u>E</u> -SNCF	Ks

Position: on the left of each side wall, or the left of each solebar in the case of high-sided open wagons or on special boards in the case of wagons without side walls (e.g. tank wagons).

Meaning (based on the first example):

31	Fitness for interoperability (2 digits)
80	Country in which the wagon is registered (2 digits)
0691	Principal technical characteristics (4 digits)
235	Number of the wagon in its production series (3 digits)
-2	Self-check digit (1 digit)
RIV	The RIV marking on wagons means that the vehicle, in addition to having been approved against the rules in force, also meets the regulations of railway Technical Unity (TU) and the provisions of leaflets in the UIC Code and, as a result, satisfies all regulations applicable for its respective type in international rail traffic. These wagons are fully interoperable.
TEN	New wagons which have obtained approval against the TSIs (Technical Specifications for Interoperability). The letters TEN (for Trans-European Network) may appear alongside or additional markings indicating the vehicle gauge.
<u>D</u>	Country in which the wagon is registered, in this case Germany

DB	Wagon keeper (abbreviation); this information is compulsory if the full name of the company complete with address is not given.
Tanoos	Reference to principal technical characteristics of the vehicle: <ul style="list-style-type: none">- T: Letter indicating wagon type (capital letter)- anoos: identification letters; lower-case letters describing the principal features for the use of the wagon

N.B.:

1. Further details are given in the Uniform Technical Prescription applicable to Vehicle Numbers and linked alphabetical marking on the bodywork: The Railway Vehicle Marking (UTP Marking), issued by the OTIF.
2. Wagons with more than 8 axles can still carry the RIV sign without satisfying the regulations on maximum load (see point 2.4) provided they meet all the other conditions of this appendix and of Appendix 9 and have no parts that are liable to encroach the vehicle gauge under any operating circumstances. Exceptions are authorised for these wagons in respect of the position of the markings.
- 3.** For wagons meeting all the requirements of the Wagons TSI WAG, the pictogram



is used in conjunction with characters 2 or 3 of the wagon number and the "TEN" marking.

- 4.** For wagons which are basically TSI WAG-compliant but which deviate in terms of their wheelbase or vehicle gauge, or which are subject to other operating restrictions when used in wagonload traffic, the pictogram



is used in conjunction with characters 4 or 8 of the wagon number and the "TEN" marking. In terms of their initial approval for placing in service, these wagons are subject to the conditions in force in all member states; however, under the OPE TSI specific agreements are to be concluded governing their use on individual member-state infrastructure.

** Official part of GCU on 1 March 2014 due to voting and adoption procedure of the GCU.

2.2 Derogation plate

Figure 1

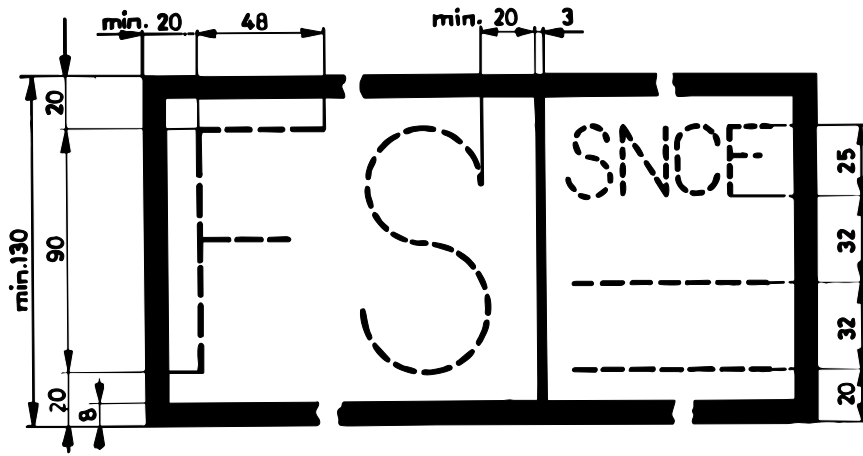

Figure 2

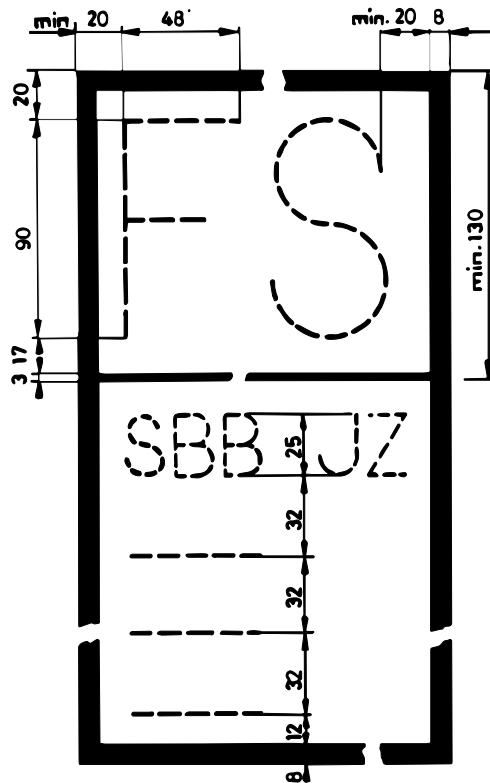

Figure 3

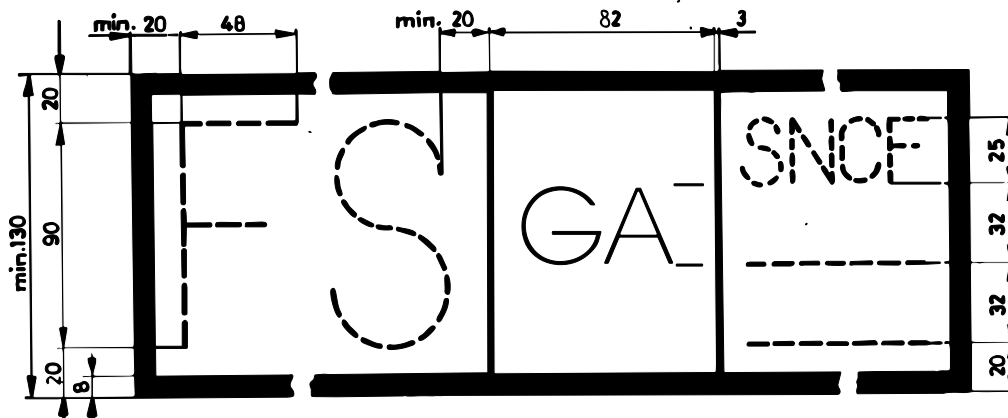
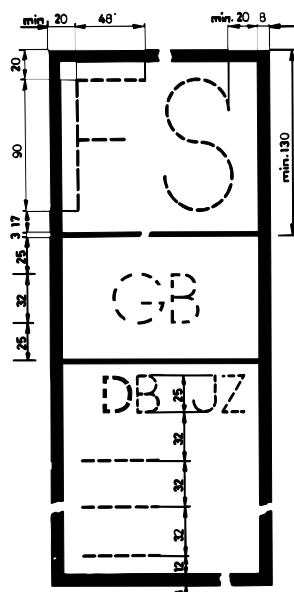

Figure 4



Position: On the right of each side wall.

Meaning: Because they do not comply fully with the UIC Code, these wagons are not marked with the “RIV” sign. Their use is therefore subject to bi- or multilateral agreements between RUs. The initials of the parties to these agreements are entered in this box and these wagons may only be used by the RUs indicated. As such, they are not fully interoperable.
 The letters GA or GB indicate the gauge to which the wagons were built, as described in **UIC leaflet 506**

2.3 Maintenance plate

Figure 1

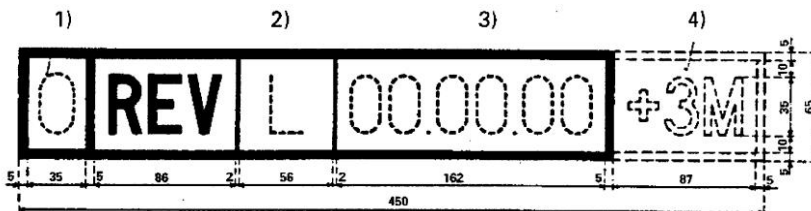
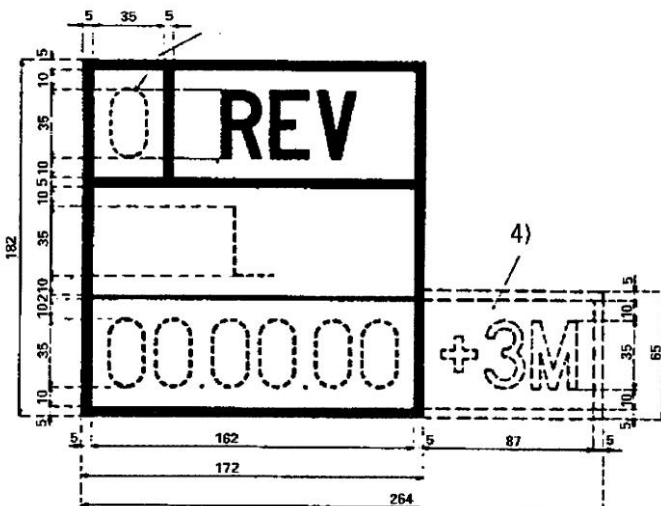

Figure 2



Position: In the middle of each solebar, or on the parts covering the solebar or on special boards fixed at the same height.

Meaning: From this day, plus the extended validity period of 3 months if duly indicated, the wagon formally loses its autorisation to run in normal service.

- 1) Maintenance plate validity period: see Appendix 10, paragraph C, point 1 or 1.1 for additional details
- 2) Identification mark of the workshop that carried out the maintenance work.
- 3) Date on which the work was carried out (day, month, year).
- 4) Additional marking in accordance with Appendix 10, paragraph C, point 1.2. To be applied only on the instructions of the keeper.

2.4 Signs indicating load limits

Figure 1

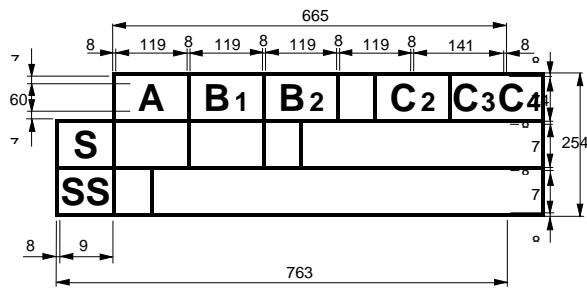

Figure 2

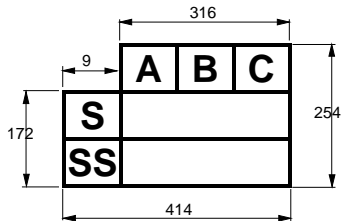

Figure 3

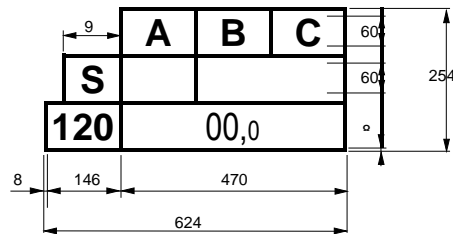

Figure 4

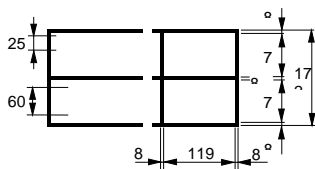

Figure 5

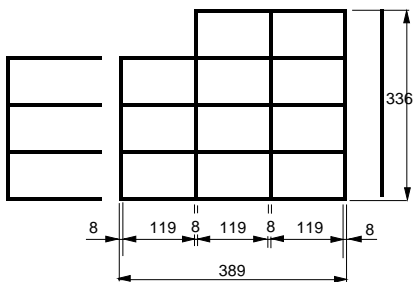

Figure 6

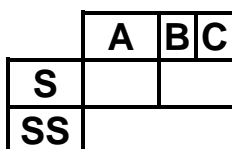

Figure 7

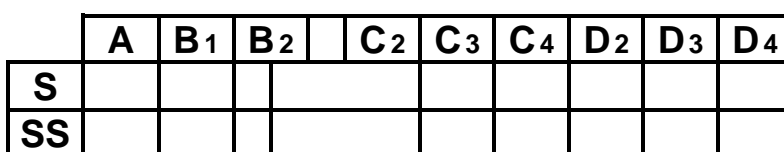

Figure 8

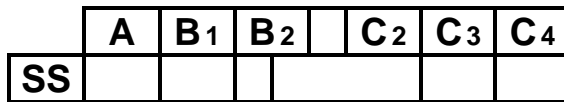

Figure 9*

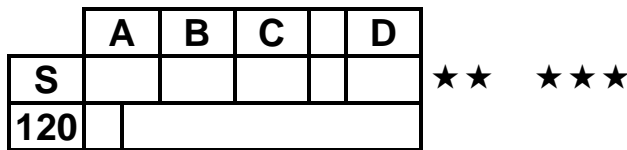

Figure 10*

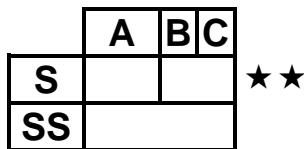
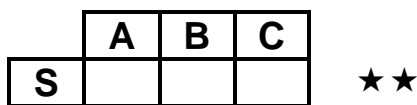

Figure 11*



* As an exception to this rule, the stars may also be positioned to the left of the load limit panel.

Position: On the left of each side wall.

- Meaning:**
- S Maximum load in t (tonnes) for wagons running in trains operated under S conditions (maximum speed 100 km/h) with no particular operating restrictions.
 - SS Maximum load in t (tonnes) for wagons running in trains operated under SS conditions (maximum speed 120 km/h) with no particular operating restrictions.
 - 120/00,0 Wagons only authorised to run in trains up to 120 km/h when empty (figures 3 and 9).
 - Fig. 4, 5 Maximum load in t (tonnes) and maximum speed (in km/h) agreed between RUs and exceeding the load limit set out in the UIC Code.
 - ★★ Maximum load in t (tonnes) for wagons authorised to run in trains up to 120 km/h with a brake that does not meet all the requirements for SS conditions.
 - ★★★*) Maximum load in t (tonnes) for wagons authorised to run in trains up to 120 km/h with a brake that does not meet all the requirements for SS conditions. The wagons must be fitted with an automatic load-proportional braking system.

N.B. 1: Wagons should only carry the markings for line category D if, for that category of line, they can accommodate a higher maximum axle-load than for category C. Wagons should only carry the markings for line category E if, for that category of line, they can accommodate a higher maximum axle-load than for category D.

N.B. 2: For wagons carrying the ★★ and ★★★ signs, RUs shall define the necessary rules for the correct formation of the train (achieving the right brake percentage, timetable changes where appropriate, etc.).

*) *Marking *** for all new wagons meeting the corresponding conditions entering service from 1.1.2007.*

2.5 Sign indicating the carrying capacity

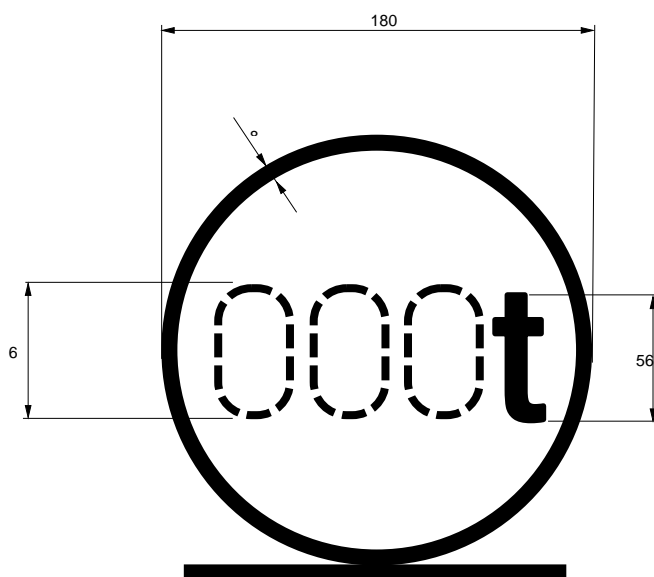

Position: On the right of each solebar, or on parts covering the solebar or on special boards fitted at the same height as the solebars

Meaning: Sign for wagons with a carrying capacity that is greater than the maximum load marked, and for wagons with no maximum load marking [t].

2.6 Signs indicating concentrated loads distributed over supporting surfaces of different lengths

2.6.1 Example of concentrated loads spread over supporting surfaces of different lengths and loads resting on two separate points (width of bearing surface ≥ 2 m)

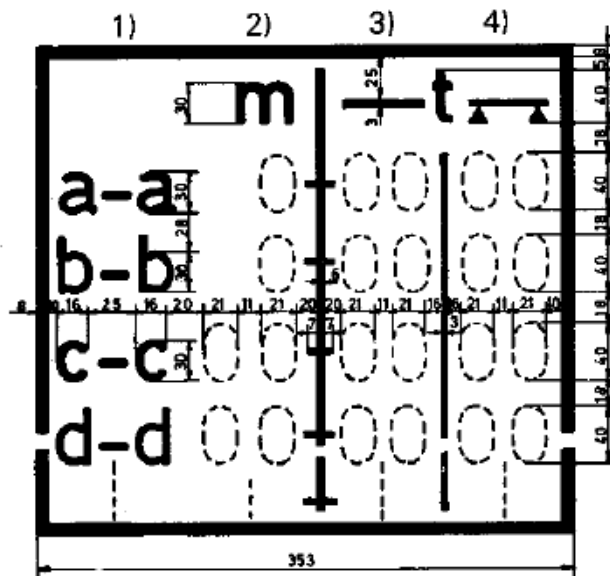
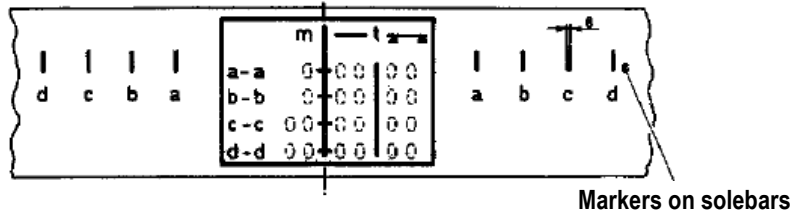

Maximum value for different lengths:
 - of concentrated loads spread over the lengths of the supporting surface
 - of loads resting on two supporting points $\blacktriangle \blacktriangle$

- 1) Indication of the length of the supporting surfaces of the concentrated loads or distance between supporting points.
- 2) Distance, in metres, between the length markers.
- 3) Maximum value, in tonnes, of the concentrated loads.
- 4) Maximum value, in tonnes, of loads resting on two supporting points.

Position: In the middle of each solebar, or on parts covering the solebar or on special boards fitted at the same height as the solebars.

Meaning: See point 2.6.2

2.6.2 Example of concentrated loads distributed over supporting surfaces of different length and loads resting on two separate points (width of bearing surface ≥ 1.20 m)

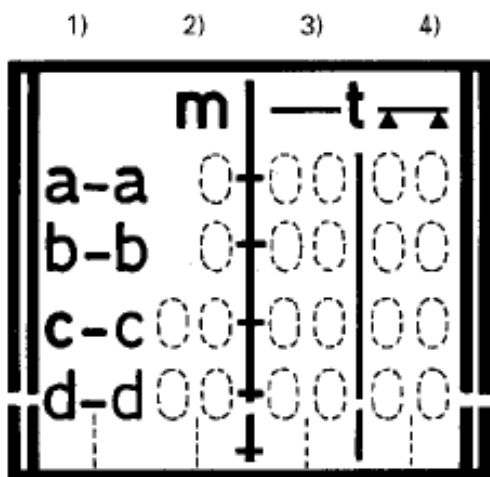
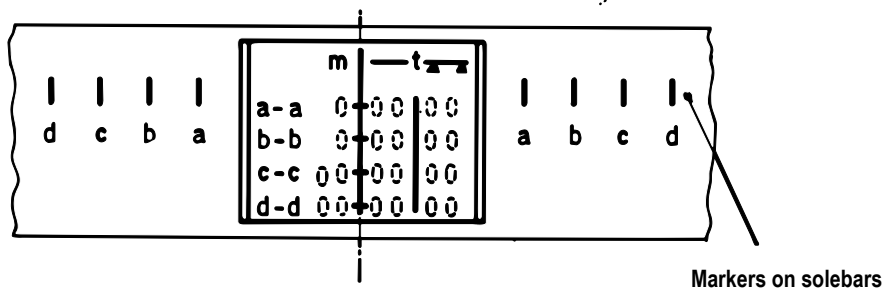

Maximum value for different lengths:
 - of concentrated loads spread over the lengths of the supporting surface _____
 - of loads resting on two supporting points ▲ ▲

- 1) Indication of the length of the supporting surfaces of the concentrated loads or distance between supporting points.
- 2) Distance, in metres, between the length markers.
- 3) Maximum value, in tonnes, of the concentrated loads.
- 4) Maximum value, in tonnes, of loads resting on two supporting points

Position: In the middle of each solebar, or on parts covering the solebar or on special boards fitted at the same height as the solebars.

Meaning of the figures shown in points 2.6.1 and 2.6.2: On unified flat wagons, this sign indicates the maximum values for concentrated loads and loads resting on 2 supporting points according to the stated values for the length of supporting surfaces and distances in the UIC Code. This sign is optional for other wagons which may, if required, carry the sign specified in points 2.6.1 or 2.6.2 or 2.6.3 or 2.6.4.

2.6.3 Example of concentrated loads distributed over supporting surfaces of different length (width of bearing surface ≥ 2 m)

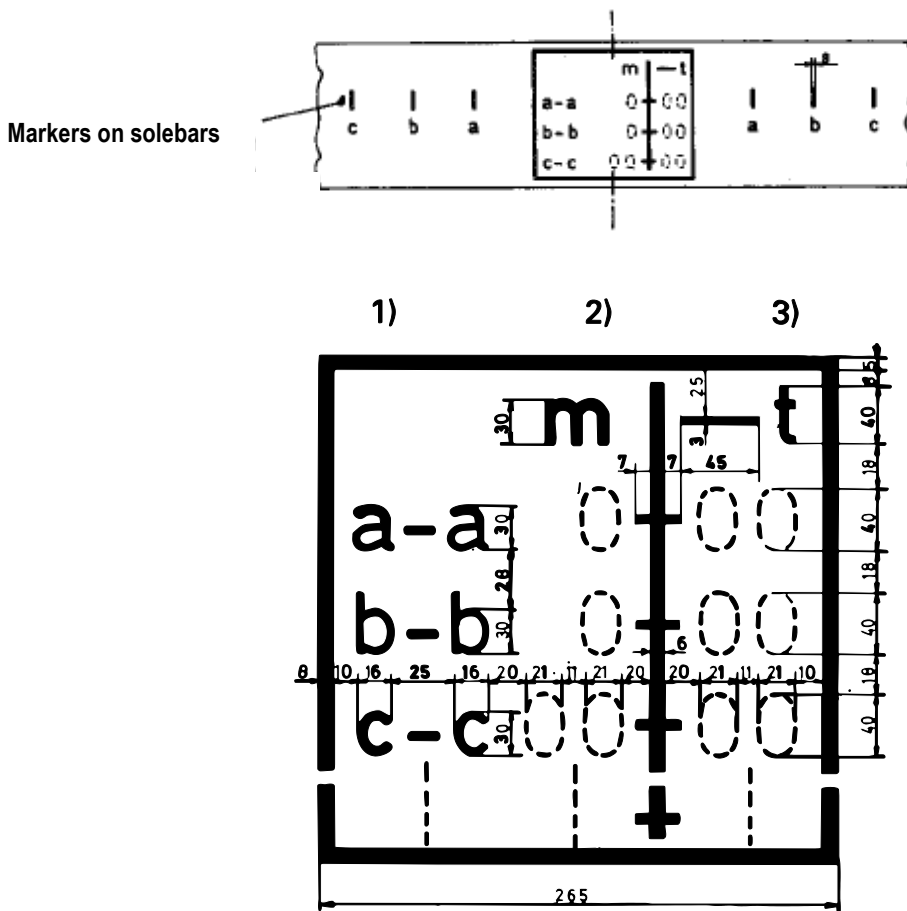

Maximum value for different lengths:
 - of concentrated loads spread over the lengths of the supporting surface

- 1) Indication of the length of the supporting surfaces of the concentrated loads or distance between supporting points.
- 2) Distance, in metres, between the length markers.
- 3) Maximum value, in tonnes, of the concentrated loads.

Position: In the middle of each solebar, or on parts covering the solebar or on special boards fitted at the same height as the solebars.

Meaning: See point 2.6.4.

2.6.4 Example of concentrated loads distributed over supporting surfaces of different length (width of bearing surface ≥ 1.20 m)

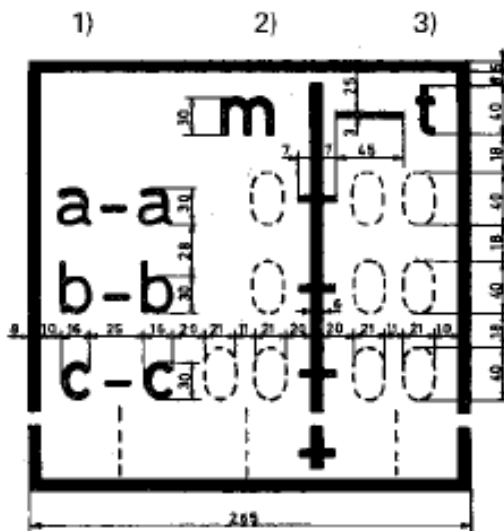
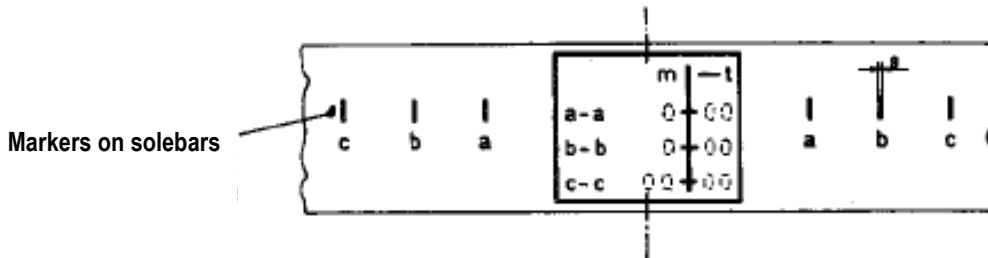

Maximum value for different lengths:
 - of concentrated loads spread over the lengths of the supporting surface

- 1) Indication of the length of the supporting surfaces of the concentrated loads or distance between supporting points.
- 2) Distance, in metres, between the length markers.
- 3) Maximum value, in tonnes, of the concentrated loads.

Position: In the middle of each solebar, or on parts covering the solebar or on special boards fitted at the same height as the solebars.

Meaning of the figures shown in points 2.6.3 and 2.6.4: For flat wagons not covered by points 2.6.1 and 2.6.2, with a loading plane more than 10 m long, and high-sided open wagons built after 1 January 1968, this sign indicates the maximum value for concentrated loads spread over supporting surfaces for at least three different lengths. This sign is optional for other wagons.

2.7 Sign indicating the capacity of tank wagons and cask wagons

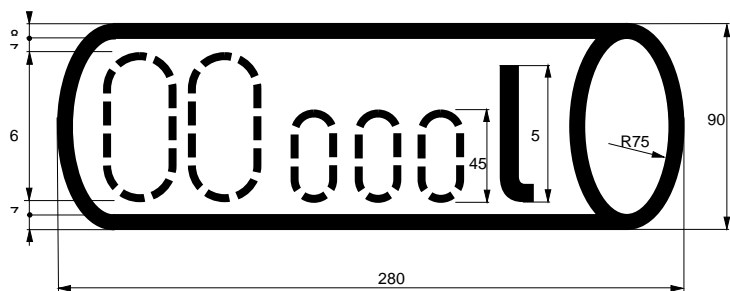

Position: On the left of each side wall; for tank wagons, on the tank itself or on special boards.

Meaning: Capacity in m³, hl or l

For tank wagons, this sign should also specify the commodities that the vehicle is authorised to carry, if required by the RID for the carriage of dangerous goods.

2.8 Signs indicating the length of load and floor space

Figure 1 Length of load

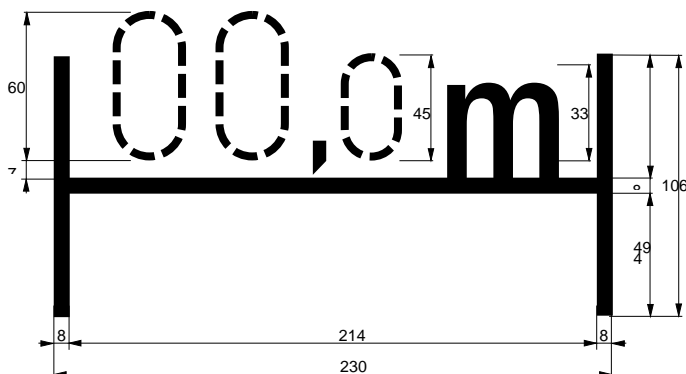

Position: On the left of each side wall.

Meaning: Loading length in [m] for flat wagons and covered wagons with a flat floor, minus the thickness of any intermediate partitions (useful length).

Figure 2 Floor space

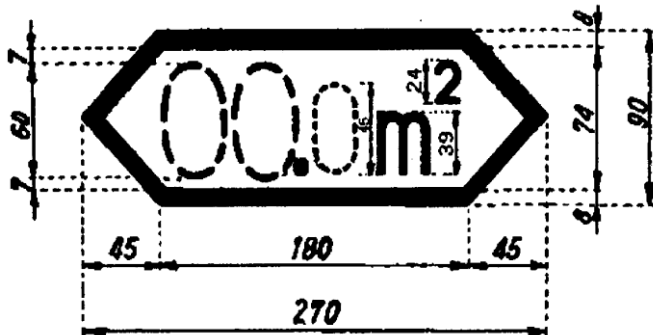

Position: On the left of each side wall.

Meaning: Surface area [m²] of the floor of covered wagons and wagons with an opening roof and flat floor.

2.9 Sign indicating the distance between end axles and bogie centres



Position: On the right of each solebar, or on the bogie frame (it is sufficient for the sign to feature on the left-hand side of the bogie, on each side of the wagon) or on parts covering the solebar or on special boards fitted at the same height as the solebars.

Meaning: Indicates the distance:

- between the end axles of bogies and of wagons other than bogie wagons,
- between the bogie centres of bogie wagons.

2.10 Sign indicating spark arrestor plates

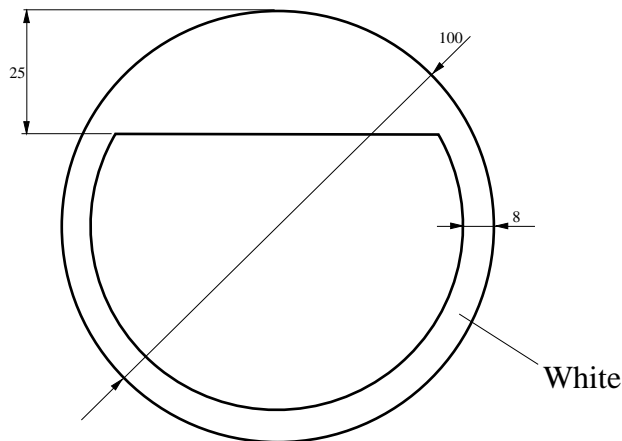

Position: In the middle of each solebar, or on parts covering the solebar or on special boards fitted at the same height as the solebars. This sign may also be affixed on the right of each side wall.

Meaning: Wagon fitted with spark-arrestor plates in accordance with Appendix A to **UIC leaflet 543**; these plates are required for axle wagons suitable for carrying class 1 commodities, sub-classes 1.1, 1.2, 1.3, 1.5 and 1.6, as well as certain commodities in classes 4.1 and 5.1 (RID, Part 7, points 7.2.4 and W 8).

– reserved –

2.11 Additional signs for wagons authorised to run in Great Britain

(NETWORK RAIL infrastructure except HS 1 high speed line from Dollands Moor to London St Pancras International) for wagons accepted on ferries or authorised to use the Cross-Channel Fixed Link (CCFL)

Figure 1: For wagons accepted on ferries and authorised to run in Great Britain (NETWORK RAIL infrastructure)

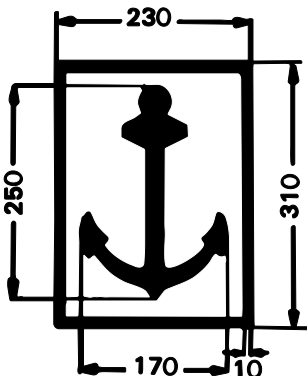
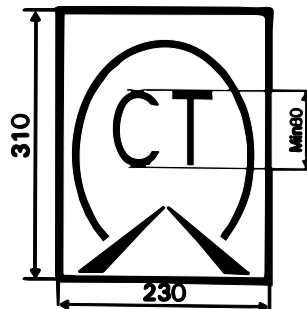

Figure 2: For wagons authorised to use the Cross-Channel Fixed Link (CCFL) and run in Great Britain (NETWORK RAIL infrastructure)



Figures 3a, 3b, 3c For wagons accepted on ferries and authorised to use the Cross-Channel Fixed Link (CCFL) and run in Great Britain (NETWORK RAIL infrastructure)

Figure 3a

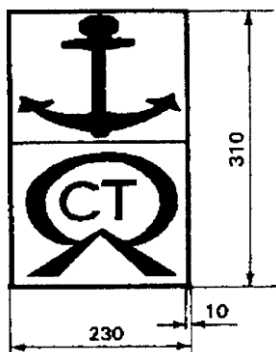

Figure 3b

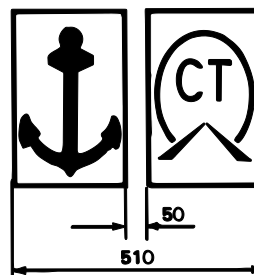
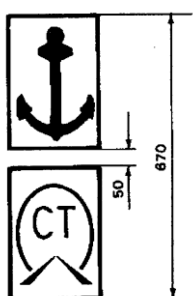

Figure 3c



Position: On the left of each side wall.

Meaning: These signs are only to be used on wagons that are authorised to run on the British rail network, based on either Figure 1 or Figure 2, or a combination of both (Figures 3a, 3b or 3c).

N.B.: Neither of these signs is necessary to use the Cross-Channel Fixed Link (Frethun to Dollands Moor) or the HS 1 high speed line from Dollands Moor to London St Pancras International.

2.12 Sign for ferry ramp angle

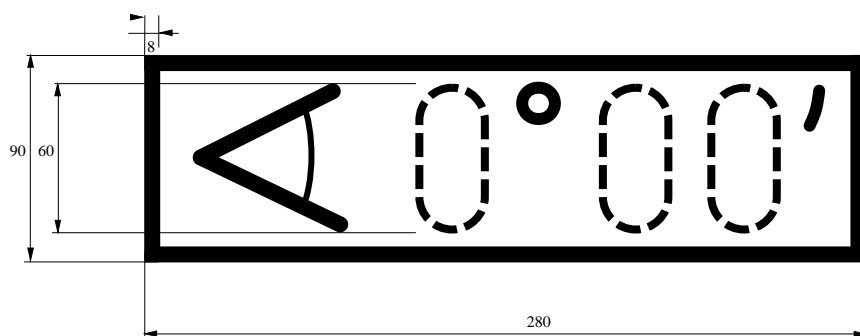

Position: On the left of each solebar, or on parts covering the solebar or on special boards fitted at the same height as the solebars.

Meaning: Indicates bogie wagons that can only negotiate a ramp angle of less than $2^{\circ}30'$ when running onto ferries.

This sign must be carried by bogie wagons which, when entering a ferry, can only negotiate a ramp angle of less than $2^{\circ}30'$. The marking should specify the maximum ramp angle.

N.B.: Regulations governing wagons that run on ferries are contained in Appendix 14.

2.13 Sign for removable wagon accessories

Removable wagon accessories

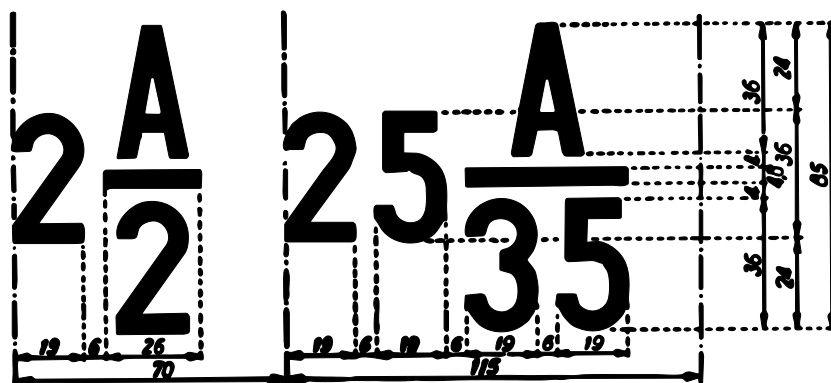

Position: On the right of each side wall.

Meaning: The number and type of removable accessories are to be indicated. In the case of carboy wagons and wagons with removable recipients, the number of such recipients should be indicated. The figure placed before the fraction indicates the number of removable accessories belonging to the wagon; the letter "A" indicates that the accessories are removable, and the denominator of the fraction gives the serial number assigned to the removable accessory in the list below. The names of the accessories may also be added in letters alongside these signs.

Serial number	Description of the removable accessory
1	Removable stanchion
2	Removable side board for flat wagon
3	Removable end board for flat wagon
4	Removable side panel
5	Removable centre post for securing load
6	Stanchion chain
7	Crank handle for car-carrying wagons
8	Adjustment device
9	Swivelling bolster with stanchions
10	Removable bolster
11 – 12	– reserved –
13	– reserved –
14	– reserved –
15 – 16	– reserved –
17	– reserved –
18	– reserved –
19	– reserved –

20	– reserved –
21	– reserved –
22	– reserved –
23	– reserved – (the folding seat for horse boxes is removed from the list)
24	Coupling rod (rigid coupling)
25	– reserved –
26	Ice tank or bunker
27	Ice tank screen
28	Ice tank frame
29	Trestle or bar with meat hooks
30	Removable cross-piece for low-loader wagons
31	Removable support bracket (for wagons used for special loads)
32	Securing crossbar (for wagons used for special loads)
33	Removable floor panel (for wagons used for special loads)
34	– reserved –
35	Wedging block
36	Skid, with or without shoes, for flat wagons used for carrying cars
37	Securing belts for flat wagons used for carrying cars
38	Girder for removable ramps for flat wagons used for carrying cars
39	– reserved –
40	Spare heating coupling
41	Fire extinguishers
42	Wheel scotches for car-carrying vehicles
43	Loading ramp, gangway
44	– reserved –
45	– reserved –
46	– reserved –
47	Metal cradles for rolls of sheeting
48	Panel for covering markings
49	Loading frame for special types of goods

2.14 Sign for the inside of wagons: "Do not use nails or wire staples"

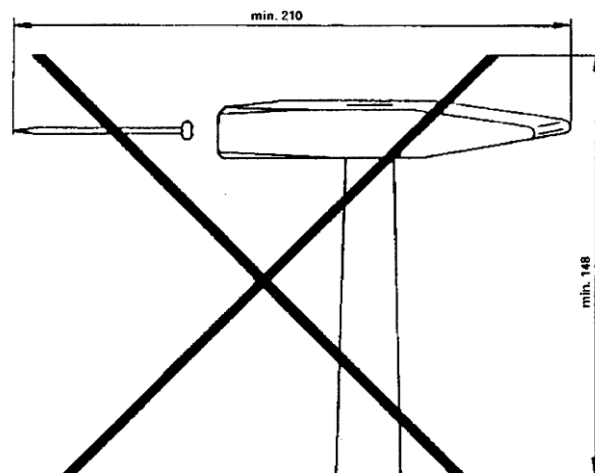

Hammer and nail:
Cross:

Outline in black
Black or red

Position: Inside the wagon in a clearly visible place, if possible at eye level.

Meaning: Nails or staples should not be used on the walls or floor of this wagon.

2.15 Marking for wagons with special fittings (wagons with automatic discharge facility, opening roof, etc.)

Example: *Wandarretierung lösen durch Schließen und Öffnen mit Bedienhebel.* *Débloquer l'arrêt mural en l'ouvrant et le fermant avec le levier de commande.*

Release wall locking device by closing and opening with control lever.

Allentare il blocco della parete mediante chiusura e apertura con la leva di servizio.

Position: At suitable places on both sides of the wagon.

Meaning: Instructions on how to operate these fittings and the safety measures to be taken, if possible in several languages. Suitable pictograms can be added to these instructions.

2.16 Signs for wagons built for running between countries with different track gauges

Signs for wagons built for running between countries with different track gauges.

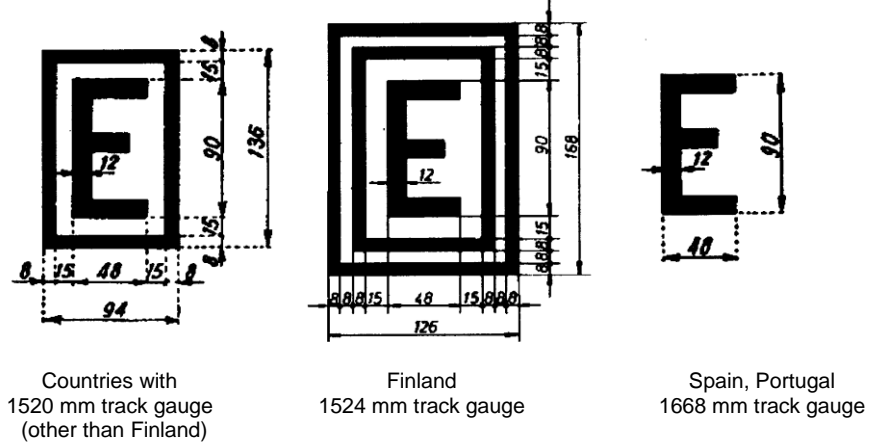

Position and meaning: see point 2.17

2.17 Signs for bogies with gauge-adjustable axles, nominal gauge 1435 mm (automatic gauge changeover facility according to the UIC leaflet 510-4)

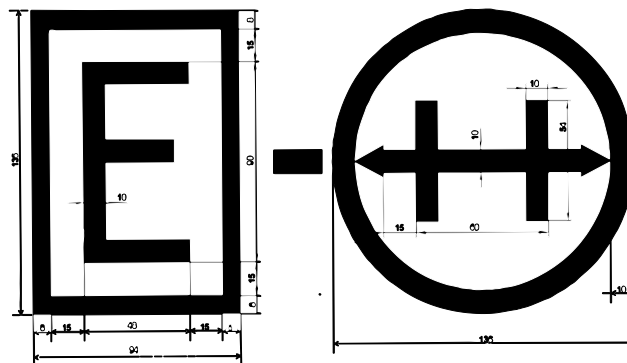

Position: On the right of each side wall. The right-hand sign on its own also features on the bogie frame.

Meaning: The signs shown in point 2.16, which indicate compliance with **UIC leaflets 430-1** and **430-3**, are affixed to wagons suitable for running between countries with different track gauges. For wagons fitted with automatic gauge changeover facilities, the sign in 2.16 is placed alongside that in point 2.17.

N.B. 1: When changing axles of this type, the date (month and year) of the last axle-box overhaul must be marked, along with the code number of the wagon keeper (owning RU or RU with which the keeper has concluded a service agreement) on the outside of each axle-box in white paint, clearly visible. Exchangeable bogies are to be fitted with a special overhaul plate.

N.B. 2: Regulations concerning the use of wagons with interchangeable axles in traffic across the Pyrenees and in traffic with Finland are given in Appendix 14.

2.18 Sign for bogies fitted with gauge-adjustable axles, nominal gauge 1520 mm (automatic gauge changeover facility according to the UIC leaflet 510-4)

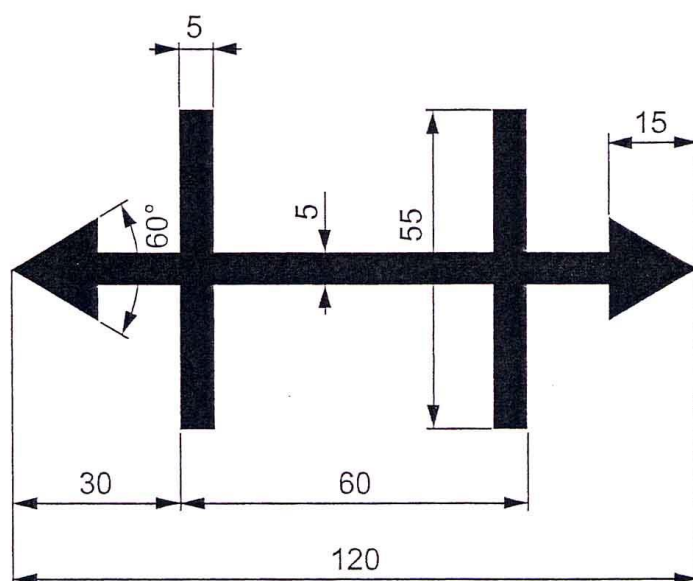

Position: On the corresponding bogie frames.

Meaning: This sign is used by RUs that are signatories to the PPW*.

The provisions of point 2.17 apply in principle.

This sign is carried by wagons that have bogies fitted with gauge-adjustable axles with a nominal gauge of 1520 mm. Wagons fitted with bogies of this type should carry the appropriate combination of the signs shown in points 2.16 and 2.18 on the right of each side wall.

***PPW** Agreement among members of the OSJD**:
"Regulations governing the use of wagons in international traffic"

****OSJD** Organisation for Collaboration between Railways, based in Warsaw

2.19 Additional signs for wagons accepted for running in Spain and Portugal

For wagons fitted with a vacuum brake:

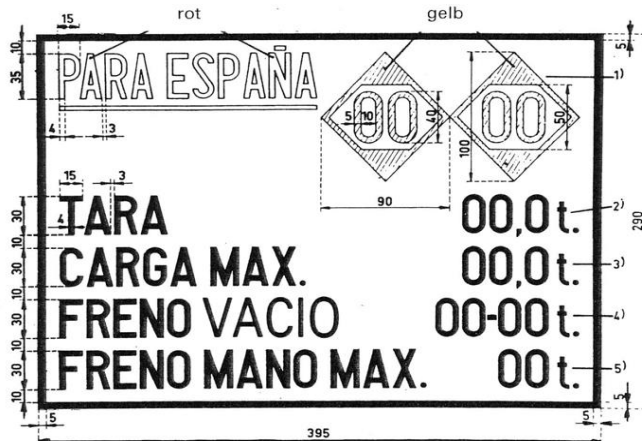

Position: On the right of each side wall, in black on wagons that are painted white, and in white on a blue background for other wagons.

- Meaning:**
- | | |
|---|--|
| <p>1. Left-hand diamond
Right-hand diamond</p> <p>2. TARA</p> <p>3. CARGA MAX</p> <p>4. FRENO VACIO</p> | <p>Maximum speed at maximum load</p> <p>Maximum speed when empty. When the maximum speeds when empty and at maximum load are the same, a single diamond marking will suffice.</p> <p>Vehicle tare.</p> <p>Maximum load limit.</p> <p>Vacuum brake</p> <p>Left-hand figure = braked weight in “empty” position,</p> <p>Right-hand figure = braked weight in “loaded” position.</p> <p>Maximum braked weight of the screw brake.</p> |
| <p>5. FRENO MANO MAX</p> | <p>Maximum braked weight of the screw brake.</p> |

For wagons with only one brake pipe for the vacuum brake:

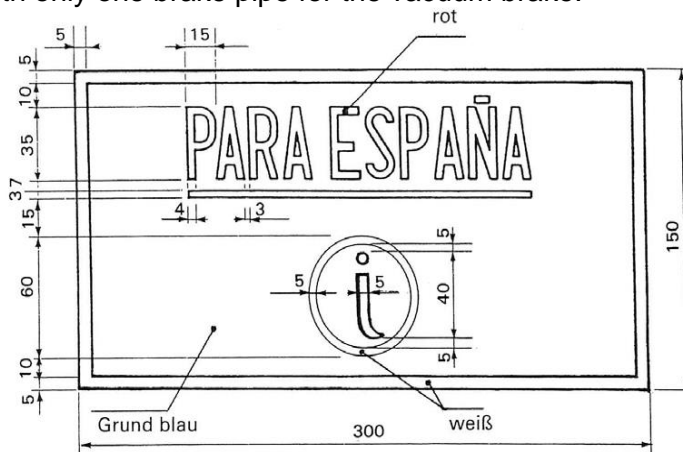

Position: On the right of each side wall, in black on wagons painted white and in white on a blue background for other wagons.

Meaning: Wagon can be included in a train with the brake isolated.

2.20 Approval plate for wagons without the TEN marking

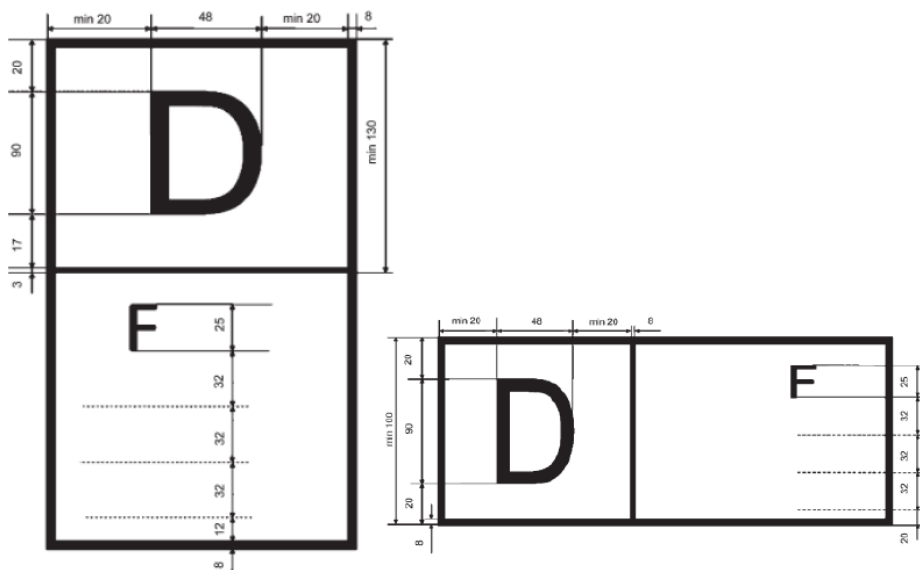

Vehicles which are not authorised for operations in all member states require an indication of the member state in which they are authorised. The list of authorising member states is to be indicated in accordance with one of the following drawings, where “D” stands for the member state which first issued authorisation (here: Germany), and “F” for the second member state which issued authorisation (here: France).

The member states are to be indicated using the codes in Annex P.4. This may concern both TSI-compliant and non-TSI-compliant vehicles. The first digit in these vehicles” codes as per Annex P.6 is code 4 or 8.

2.21 Marking of vehicle gauge on wagon

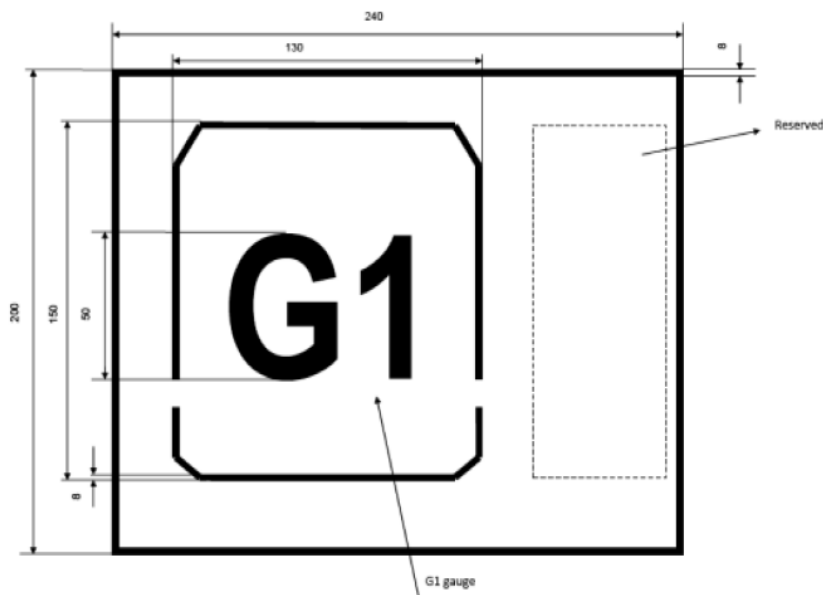

Indicates wagons built to vehicle gauge “G1” and authorised for interoperable traffic.

3.1 Height of the loading plane for container wagons in unladen state

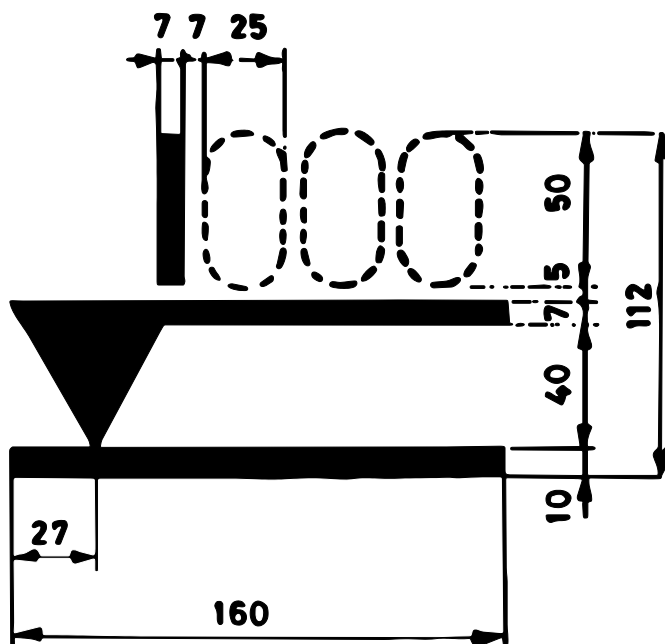

Position: On the right of each solebar.

Meaning: This sign is carried by container wagons that are suitable for transporting large containers and/or swap bodies. It indicates the height in millimetres of the loading plane when the wagon is not loaded.

3.2 Signs for combined transport wagons in accordance with UIC leaflet 50571-4

On swap-body carrier wagons and on carrier wagons with independent axles that have equivalent or more favourable characteristics for the coding of load units.

ISO container on wagon with a bogie pivot pitch > 16,15 up to 20,00 m (UIC Leaflet 50571-4)

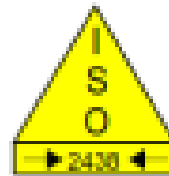
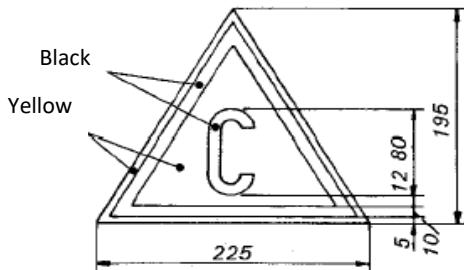

On type 1a and 1b recess wagons and variants for carrying semi-trailers that exceed specified capacity

On recess wagons for semi-trailers

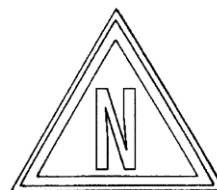
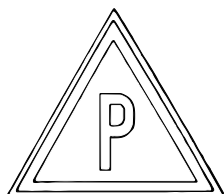



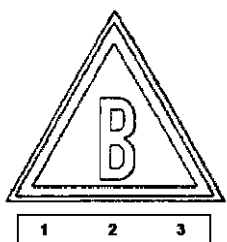



On roller-unit carrier wagons



Position: on the left of each side wall.

For wagons used in rail/road combined transport, the following signs:

- On recess wagons for semi-trailers whose characteristics are defined in point 3.3.2 and Appendix 3.4 of **UIC leaflet UIC 50596-6**,
- On recess wagons for semi-trailers whose characteristics are defined in point 3.3.2 and Appendix 3.4 of **UIC leaflet 50596-6**,
- On swap-body carrier wagons whose characteristics are defined in point 3.3.2 and Appendix 3.3 of **UIC leaflet 50596-6**,
- On roller-unit carrier wagons whose characteristics are defined in point 3.3.2 and Appendix 3.3 of **UIC leaflet 50596-6**,

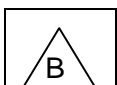
- | | | |
|---|---|---|
| - |  | |
| | | On swap-body carrier wagons whose characteristics do not meet the conditions of point 3.3.2 of UIC leaflet 50596-6 , |
| | | |
- | | | |
|---|---|--|
| - |  | |
| | +23 | On swap-body carrier wagons whose characteristics are more favourable than the conditions in point 3.3.2 of UIC leaflet 50596-6 , |
- | | | |
|---|---|--|
| - |  | |
| | | On carrying wagons for ISO containers whose characteristics do not meet the requirements of point 3.3.2 of UIC leaflet 596-6 |
| | | |
- | | | |
|---|---|--|
| - |  | |
| | | On recess wagons whose characteristics when carrying semi-trailers do not meet the conditions of point 3.3.2 of UIC leaflet 50596-6 , |
| | | |
- | | | |
|---|---|---|
| - |  | |
| | +5 | On recess wagons whose characteristics when carrying semi-trailers are more favourable than the conditions in point 3.3.2 of UIC leaflet 50596-6 , |
- | | | |
|---|---|---|
| - |  | |
| | 1 2 3 | On roller-unit carrier wagons whose characteristics do not meet the conditions of point 3.3.2 of UIC leaflet 50596-6 , |
| | +3 | |
| | -2 | |
- | | | |
|---|---|--|
| - |  | |
| | 1 2 3 | On roller-unit carrier wagons whose characteristics are more favourable than the conditions in point 3.3.2 of UIC leaflet 50596-6 . |
| | +6 | |

Pictogram for seating devices unsuitable for use with steering wedges

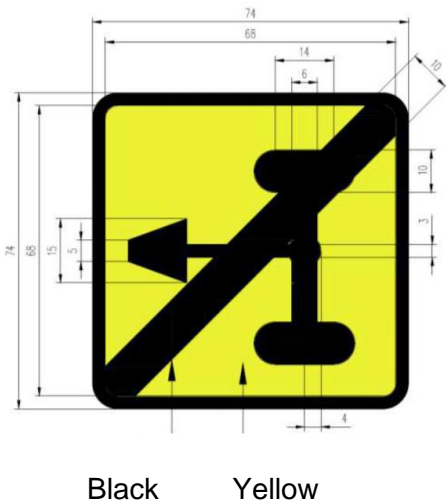

If the seating device is unsuitable for use with steering wedges, the recess wagon is to be marked with the following pictogram, near the wagon compatibility code.

Pictogram to affix for heavy-duty swap bodies transport

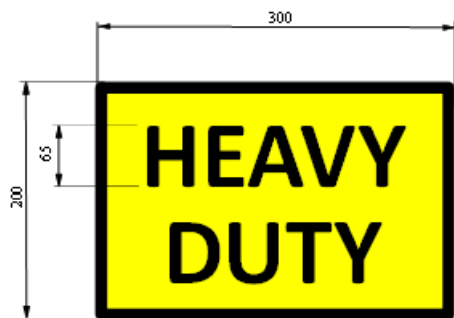

This pictogram is positioned on the solebar near the compatibility code of the wagon on the carrier wagon **with marking of reinforced tensioning fittings**

Loading diagram for carrier wagons for heavy-duty swap bodies transport

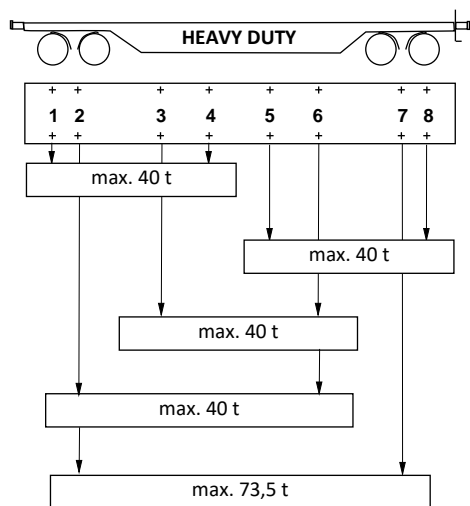

The loading diagram must be affixed to wagons with reinforced tensioning fittings.

The inscription shall indicate the maximum total permissible mass for each loading position.

The loading diagram shall be at least A4 size and shall be affixed to the solebar

On swap-body carrier wagons whose characteristics do not meet the conditions of point 3.3.2 of UIC leaflet UIC 50596-6

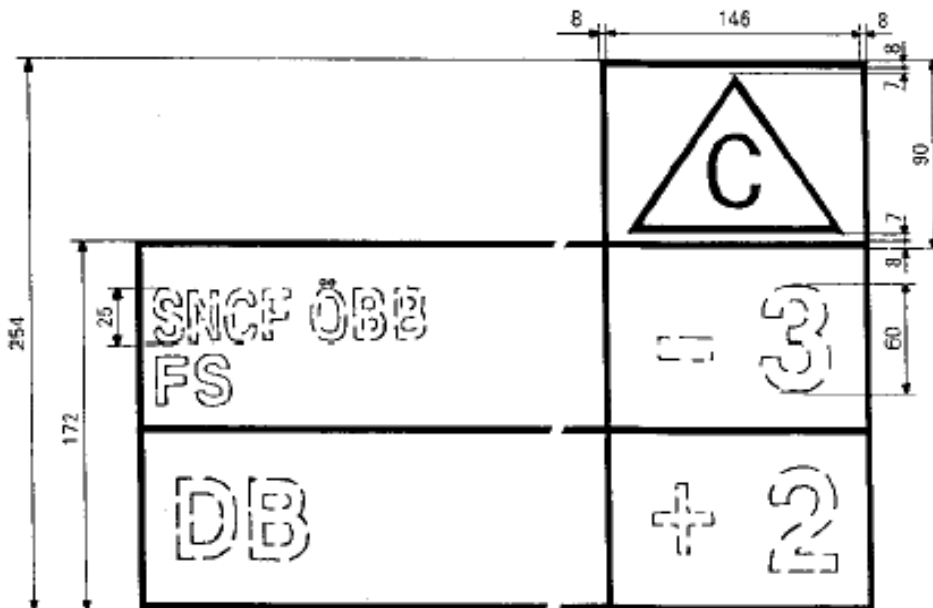

On swap-body carrier wagons with characteristics more favourable than the conditions in point 3.3.2 of UIC leaflet 50596-6

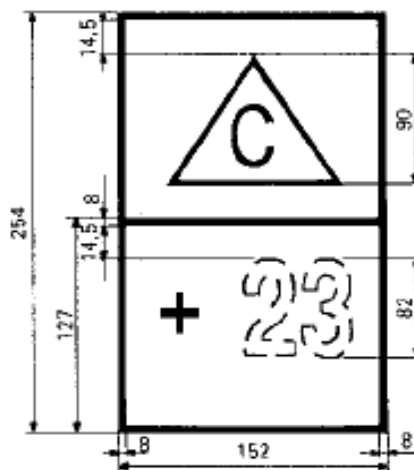

Meaning:

- “- 3”:
The wagon can only be loaded with swap bodies that have a profile number that is lower (in this example by at least 3 points) than the profile number assigned to the RU (or RUs) concerned.
- “+ 2”:
The wagon can be loaded with swap bodies that have a profile number that is greater (in this example by up to 2 points) than the profile number assigned to the RU (or RUs) concerned.
- “+ 23”:
The wagon can be loaded with swap bodies that have a profile number that is greater (in this example by up to 23 points) than the profile number assigned to the RU (or RUs) concerned.

On recess wagons whose characteristics when carrying semi-trailers do not meet the conditions of point 3.3.2 of UIC leaflet 50596-6

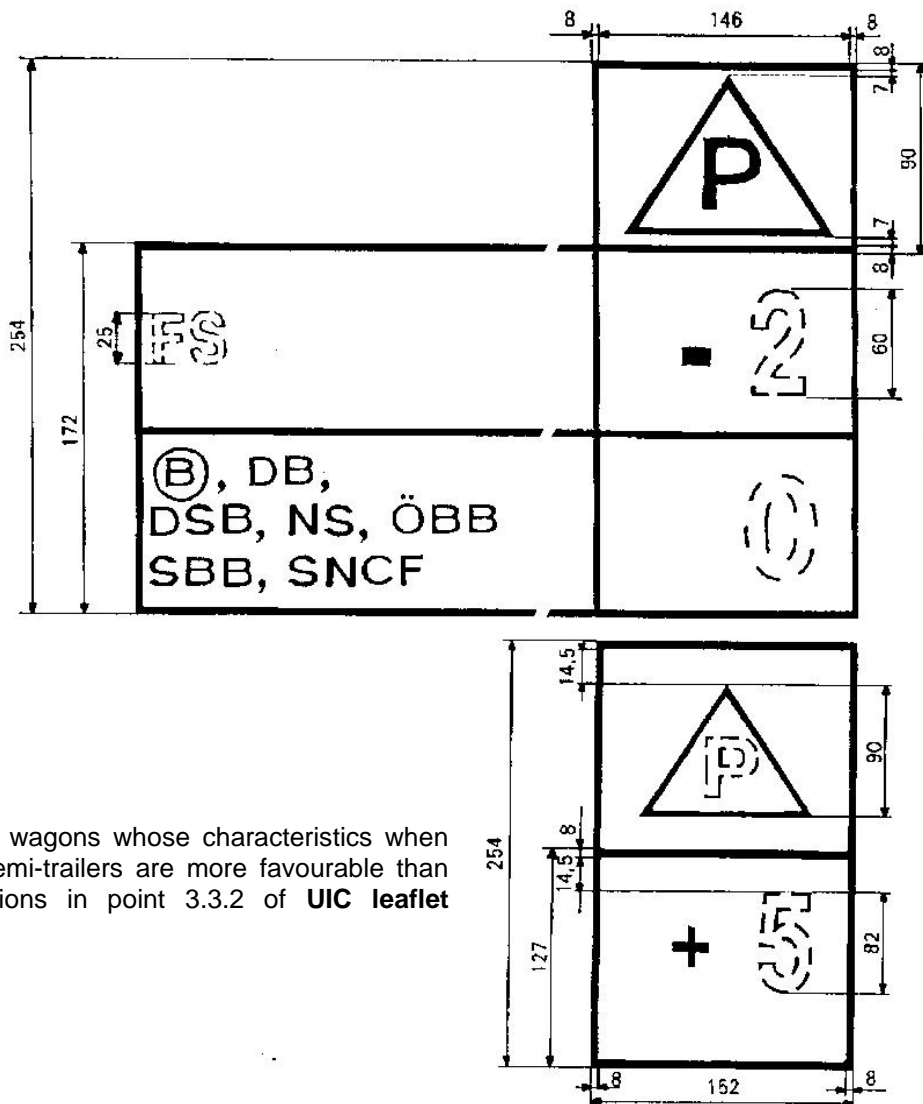

On recess wagons whose characteristics when carrying semi-trailers are more favourable than the conditions in point 3.3.2 of UIC leaflet 50596-6

Meaning:

- “- 2”:
The wagon may only be loaded with semi-trailers that have a profile number that is lower (in this example by at least 2 points) than the profile number assigned to the RU (or RUs) concerned.
- “0”:
The wagon may only be loaded with semi-trailers that have a profile number that is no higher than the profile number assigned to the RU (or RUs) concerned.
- “+ 5”:
The wagon can be loaded with semi-trailers that have a profile number that is greater (in this example by up to 5 points) than the profile number assigned to the RU (or RUs) concerned.

On roller-unit carrier wagons whose characteristics do not meet the conditions of point 3.3.2 of UIC Leaflet 50596-6

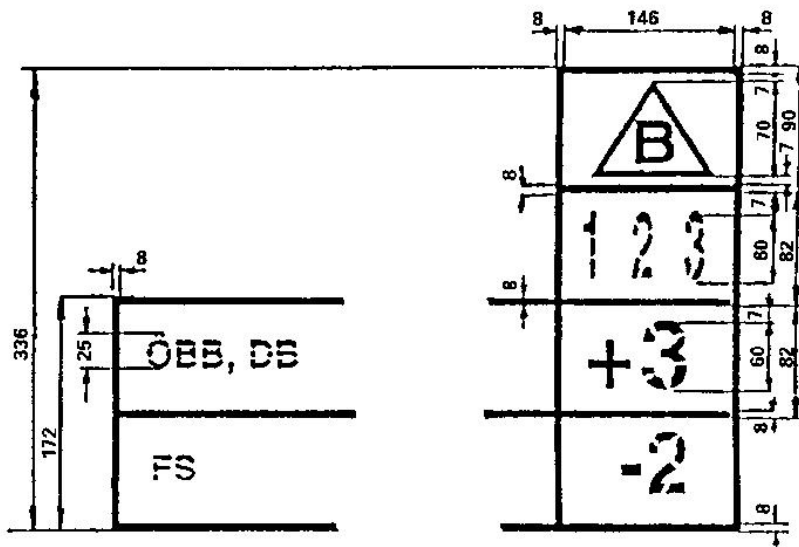

On roller-unit carrier wagons with characteristics more favourable than the conditions in Point 3.3.2 of UIC leaflet 50596-6

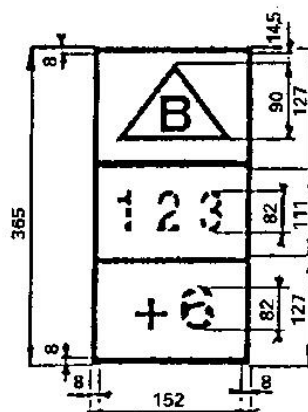

Meaning:

- “+ 3”:** The wagon may be loaded with roller units that have a profile number that is greater (in this case by up to 3 points) than the profile number assigned to the RU (or RUs) concerned.
- “- 2”:** The wagon may only be loaded with roller units that have a profile number that is lower (in this example by at least 2 points) than the profile number assigned to the RU (or RUs) concerned.
- “+ 6”:** The wagon may be loaded with roller units that have a profile number that is greater (in this example by up to 6 points) than the profile number assigned to the RU (or RUs) concerned.

Compatibility code definition in accordance with UIC leaflet 50596-5

Recess wagons with enlarged clearance envelopes are given a compatibility code which takes the form of the code letter from the wagon compatibility code (in this case "P") and one of the lower-case letters approved by UIC for specific clearance envelopes / wagon types.

The letters are marked on the recess wagon and in the semi-trailer code number plate and must match when loaded.

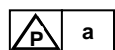

Clearance envelope for P semi-trailers with compatibility code "a" on type 4 recess wagon with seating device 113 or 98 cm high



Clearance envelope for P semi-trailers with compatibility code "b" on recess wagon types BA 739 and 744 with seating device 113 or 98 cm high

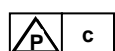

Clearance envelope for P semi-trailers with compatibility code "c" on type 2000 recess wagon with seating device 113 or 98 cm high

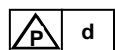

Clearance envelope for P semi-trailers with compatibility code "d" on Mega 2 type recess wagon with seating device 113, 98 or 85 cm high

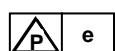

Clearance envelope for P semi-trailers with compatibility code "e" on type 5 recess wagon with seating device 113, 98 or 88 cm high



Clearance envelope for P semi-trailers with compatibility code "f" on type 3000 recess wagon with seating device 113, 98 or 88 cm high

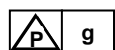

Clearance envelope for P semi-trailers with compatibility code "g" on Twin type recess wagon with seating device 113, 98 or 88 cm high



Clearance envelope for P semi-trailers with compatibility code "h" on type 4.2 recess wagon with seating device 113 or 98 cm high

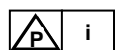

Clearance envelope for P semi-trailers with compatibility code "i" on type MTW recess wagon with seating device 113, 98 or 88 cm high

4.1 Sign for length over buffers

Length over buffers



Position: On the left of each side wall.

Meaning: Indicates the wagon's length over buffers in metres [m].

On wagons made up of separate units joined together by a permanent coupling (multiple wagon units) the total length of the wagon should be indicated.

4.2 Signs for tare and braked weight

Figure 1: Wagon tare



Figure 2: Wagon tare and braked weight of the platform-operated hand brake

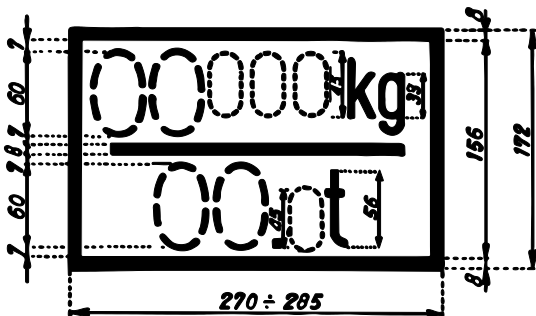
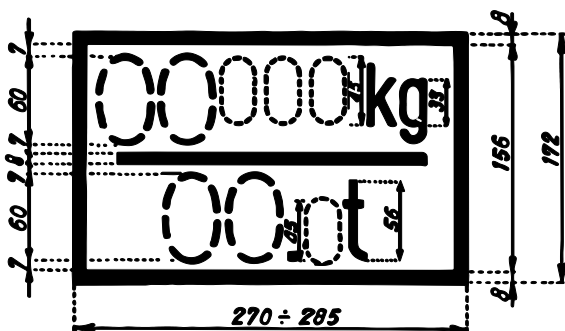

Figure 3: Wagon tare and braked weight of the ground-operated hand brake (the latter to be shown in a red box)



Position: On the left of each side wall

Meaning: Indicates the wagon tare (upper figure) and braked weight (lower figure).
 The sign shown in figures 2 or 3 is marked on the wagon when the braked weight is less than the total mass of the vehicle (tare + load corresponding to the maximum weight).
 The braked weight as shown in figure 3 must be marked in a red box when it refers to a ground-operated hand brake.
 When a wagon is fitted with more than one independently-acting hand brake, the corresponding number of brakes must be indicated in front of the braked weight marking (for example: 2 x 00.0 t).

N.B.: The sign shown in Figure 1 must **not** be affixed to a wagon that is to carry the sign in Figure 2 or 3.

Fig. 4: Marking indicating the braked weight and the holding force in kN on vehicles fitted with screw brakes

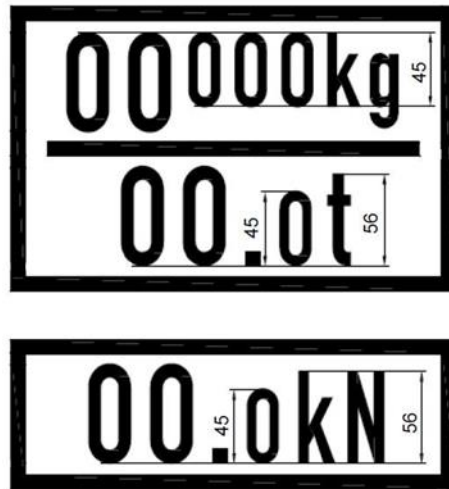

Note

If the wagons are equipped with more than one screw brakes independent of each other, it is appropriate to specify the quantity in front of the relevant indication of holding force (e.g. 2 x 00.0 kN)

Remark: This marking is mandatory as of 1/1/2021.

4.3 Signs to indicate the changeover device for air brakes - Marking of the braked weight on wagons. Brake type abbreviations

4.3.1 Marking of the braked weight of wagons without changeover device

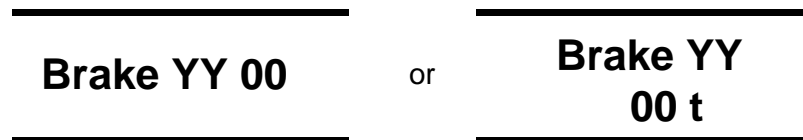

Position: On each solebar, close to the indication of the brake system.

Meaning: Sign indicating the brake type (YY) as shown in point 4.3.9 and indication of the braked weight (t). This marking may be preceded by the word "brake" (optional).

4.3.2 "Freight / Passenger" (G/P) changeover device (hand operated)

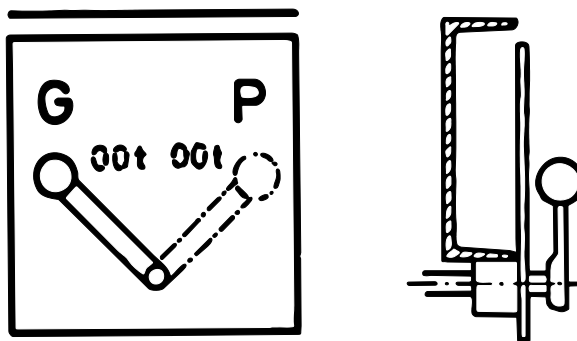

Position: On the plate behind the changeover lever, alongside the corresponding lever position, if the braked weights (t) in the "freight" (G) and "passenger" (P) positions are different.

Meaning: On wagons that are fitted with a "Freight / Passenger" (G/P) changeover device, the changeover from one regime to another is made using a lever fitted with an end knob (as illustrated in point 4.3.2).

In the "freight" braking mode, the lever slants upwards and to the left.

In the "passenger" braking mode, the lever slants upwards and to the right.

4.3.3 "Empty / Loaded" changeover device (hand operated)

Vehicles fitted with a single "empty/loaded" changeover device (figures 1 and 2)

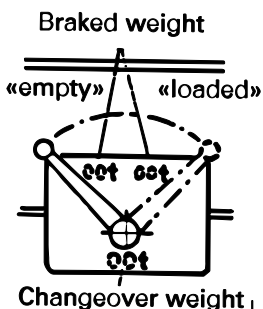

Fig. 3 : «Empty» braking position plus one «Loaded» braking position

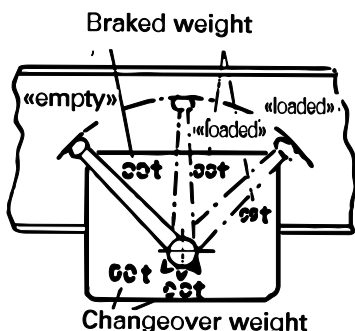
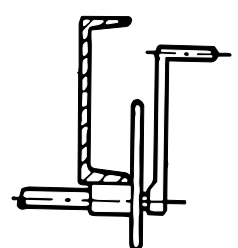
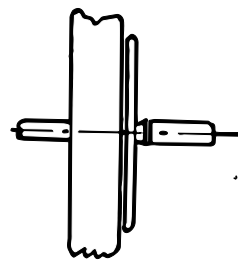

Fig. 4 : «Empty» braking position plus several (for example two) «Loaded» braking positions



Vehicles fitted with 2 or more "empty/loaded" changeover devices (figures 3 and 4)

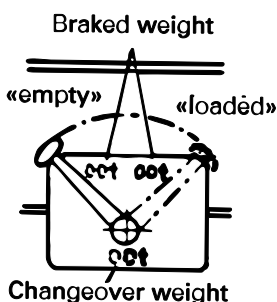

Fig. 5 : «Empty» braking position plus one «Loaded» braking position

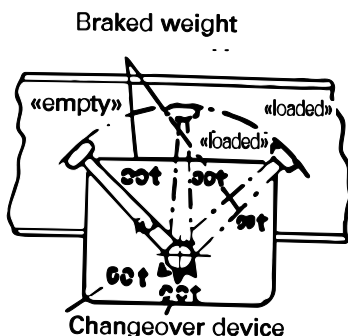
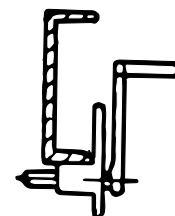
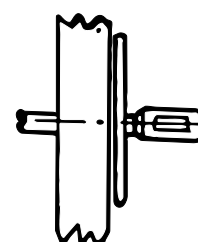

Fig. 6 : «Empty» braking position plus several (for example two) «Loaded» braking positions



Position figures 1 to 4: On each solebar, approximately in the middle of the wagon, on the plate behind the changeover lever. The braked weights (t) are marked next to the corresponding position of the lever. The changeover weights [t] are indicated on the same plate, near the point of rotation of the lever.

Meaning

On wagons featuring an "empty" braking mode and one or more "loaded" braking modes, the changeover from one mode to another is done using a crank handle as shown in the above figures 1, 2, 3 or 4.

When the wagon has only a single "empty / loaded" device, it will be fitted with a lever of the kind shown in figures 1 or 2.

When the wagon has two or more separate "empty / loaded" devices, the levers are fitted with a handle as shown in figures 3 or 4.

In the "empty" braking mode, the lever slants upwards and to the left and will occupy its extreme left-hand position if:

- the wagon is empty,
- the gross weight (tare + load) is less than the changeover weight marked,
- the mass per axle or per bogie is less than half of the changeover weight marked.

In the "loaded" braking mode, in other words when the gross weight (tare + load) is greater than or equal to the changeover weight (the highest, when there are several "loaded" positions), the lever slants upwards to the right and occupies the extreme right-hand position.

The positions corresponding to the other loaded braking modes are situated between these extreme positions, the braking power increasing from left to right.

4.3.4 Vehicles fitted with automatic load-proportional braking system

Figure 1

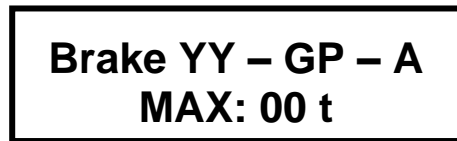

Position: In a box painted on each solebar.

Meaning: Indication of the type of brake (YY) in accordance with point 4.3.9. Additional information also shown in point 4.3.9 (GP, A) and indication of the maximum braked weight [t] → Up to this maximum value, the braked weight [t] is equal to the sum of the wagon tare and the load [t]. This information may be preceded by the word "brake" (optional).

Figure 2

Bremse...-G-A

Position: On each solebar, after the brake system marking.

Meaning: On some older wagons, the braked weights for each load state (maximum of five) are shown as tables. Each column in the table contains two figures:

- above: the braked weight value [t];
- below: minimum weight on rail [t] giving a braked weight [t] at least equal to this value.

4.3.5 Vehicles fitted with an automatic "empty / loaded" changeover device

Figure 1 Vehicles featuring several braked weight values in the "freight" and "passenger" changeover

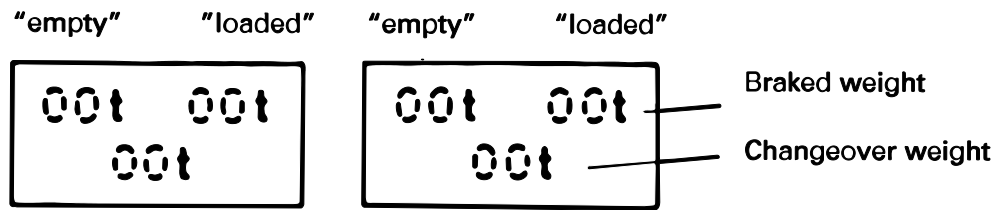

Figure 2 Vehicles featuring a single braked weight value in the "freight" and "passenger" changeover

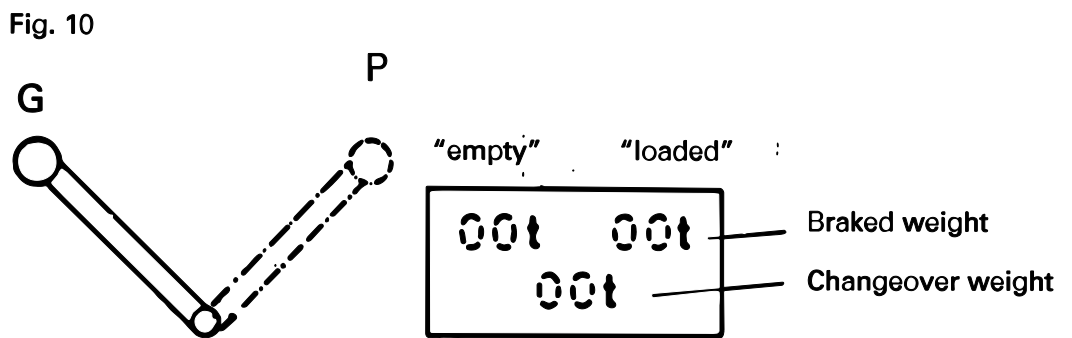
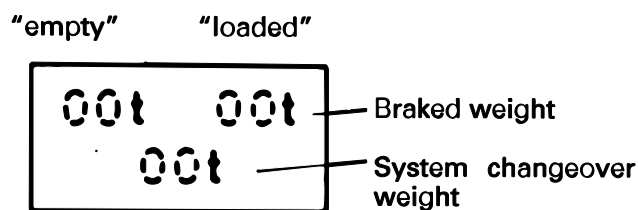

Figure 3 Vehicles featuring a "freight" brake or "passenger" brake only



Position figures 1 – 3: On each solebar near to the brake system marking.

Meaning: On these wagons, the "empty / loaded" changeover takes place automatically when the gross weight (wagon tare + load) [t] is greater than the changeover weight [t] marked.

4.3.6 Marking of the axles of wagons with a single distributor

On wagons fitted with a single brake distributor, an identification marking (serial number) can be applied to the solebar above each axle-box (optional).

4.3.7 Signs for wagons with more than one distributor

a) Wagons with more than one distributor and separate "empty / loaded" changeover systems

The braked weight [t] of the associated distributor and the changeover weight [t] for the wagon must be marked on the identification plates for each "empty/loaded" changeover device (see point 4.3.3).

b) Wagons with several distributors and automatic load-proportional brakes

Figure 1

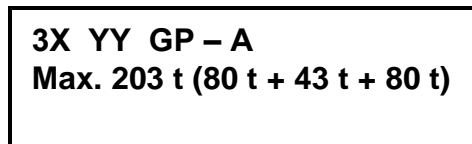
**Meaning:**

Example of markings for multiple wagons with three distributors (3X), letter code for brake type in accordance with point 4.3.9 (YY); additional letters in accordance with point 4.3.9 (GP, A).

The braked weights [t] of the corresponding distributor should be marked on the plates for each "empty-loaded" changeover device together with the changeover weight for the wagon as a whole.

Figure 2

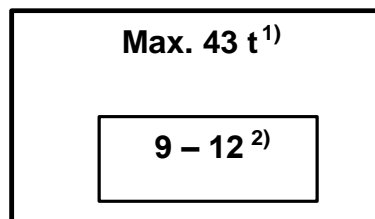
**Position of figures 1 and 2**

On each solebar near the brake isolating levers.

Meaning:

- 1) Braked weight delivered by the system controlled by the distributor in question.
- 2) Indication of the end numbers of the axles on which this braking system acts.

The following must also be indicated (see point 4.3.7):

- the number of brake systems,
- the total braked weight and in brackets the braked weight obtained from each distributor.

4.3.8 Marking of the axles of wagons fitted with several distributors and an automatic load-proportional braking system

On multiple wagons with permanent couplings fitted with several distributors and an automatic load-proportional braking system, an identification number should be marked on the solebars to indicate the corresponding position of the axle in ascending order from one end of the wagon to another. This marking must be made by 1.1.2007.

4.3.9 Abbreviated references for compressed air brakes accepted for international traffic as of 1.3.2005

1. Brake type

Kunze-Knorr	Kk
Drolshammer	Dr
Bozic	Bo
Hildebrand-Knorr	Hik
Breda	Bd
Charmilles	Ch
Oerlikon	O
Knorr, type KE	KE
Westinghouse, type E	WE
Dako	DK
Westinghouse, type U	WU
Westinghouse, type A *(approved until 1.1.2000 for new built-wagons)	WA*
Davies and Metcalfe, Distributor DMD 3	DM
MZT HEPOS	MH
SAB-WABCO, Type SW 4/SW 4C/SW 4/3	SW
Distributor KE-483 * (In position "483" the brake meets the conditions of the CIS networks).	KE 483**
Bumar-Fablok MBF-01A, MBF-01B, MBF-02	FL

2. Additional references

Freight train brake	G
Passenger train brake	P
High power brake	R
G/P changeover device	GP
P/R changeover device	PR
G/P/R changeover device	GPR
Automatic load-proportional braking system	A
Electromagnetic rail brake	Mg

Position: In the middle of each solebar, or on parts covering the solebar or on special boards fitted at the height of the solebars, near the changeover devices for the brake with the other brake markings.

4.4 Signs for wagons fitted with composite brake blocks

Position: On both sides of the wagon, directly to the right of the marking indicating the type of brake.

Meaning: Marking for vehicles fitted with composite brake blocks with a

- high coefficient of friction ('K' type block)
- medium coefficient of friction ("L" type block)
- low coefficient of friction ("LL" type block)

Ivory to yellow

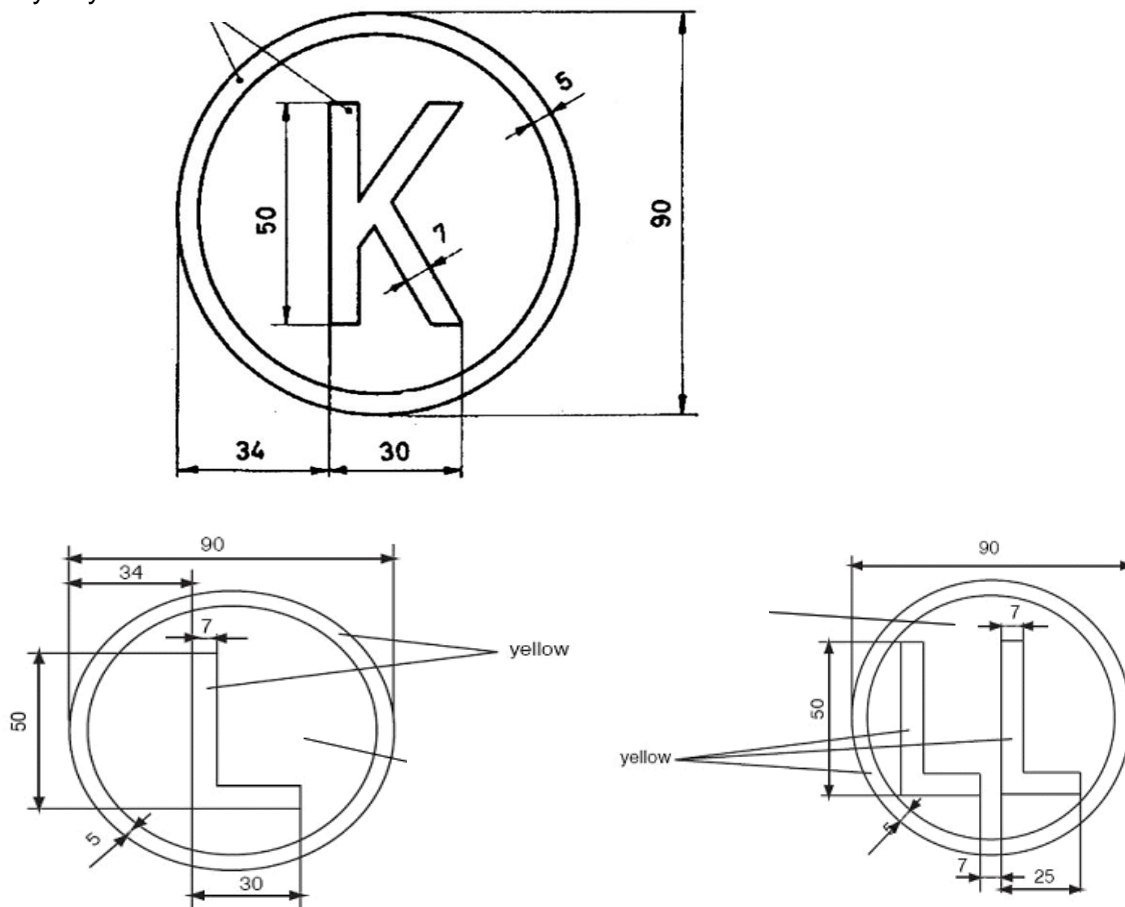

Sign(s) (e.g. C810, J816M): directly below or next to the symbol corresponding to the "K" type block. Declaration of several types of blocks possible.



4.5 Sign for wagons fitted with disc brakes

Ivory to yellow

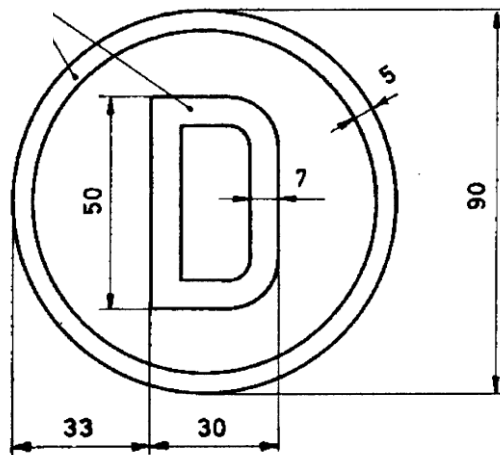

Position: On both sides of the wagon, directly to the right of the marking indicating the type of brake.

Meaning: Wagons that carry this sign are fitted with disc brakes.

5.1 Sign for wagons not authorised to negotiate all shunting humps

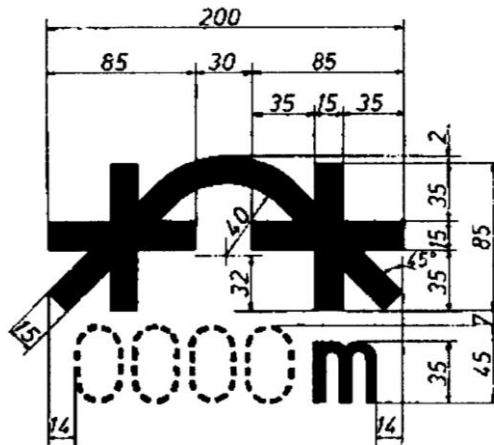

Position: On the left of each solebar, or on parts covering the solebar or on special boards fitted at the same height as the solebars.

Meaning: This marking is compulsory for wagons which, because of their design are liable to sustain damage when crossing shunting humps with a vertical radius of 250 m. The value marked indicates the smallest curve radius that the wagon can negotiate.

5.2 Sign for bogie wagons with a distance of more than 14.0 m between inner axles and accepted on shunting humps

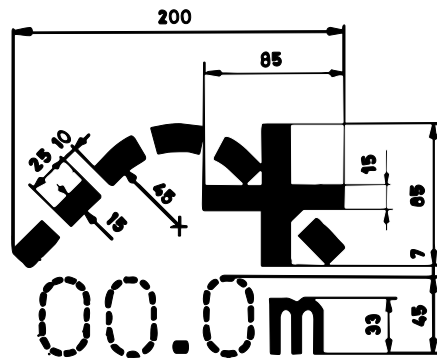

Position: On the left of each solebar, or on parts covering the solebar or on special boards fitted at the same height as the solebars.

Meaning: This marking is compulsory on bogie wagons that are suitable for crossing shunting humps, but which have a distance of more than 14.0 m between consecutive inner axles. The value indicated is the largest distance between two consecutive axles.

5.3 Sign for wagons that are not authorised to pass through retarders or other shunting and stopping devices in active mode

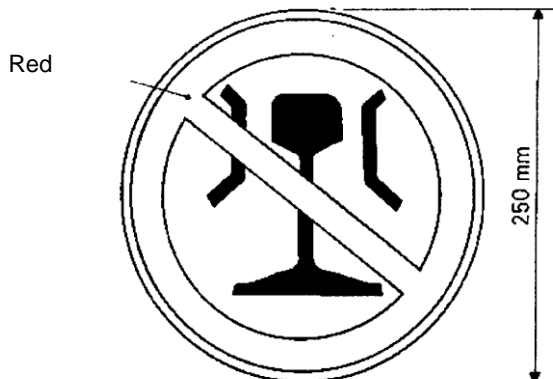

Position: On the left of each solebar, or on parts covering the solebar or on special boards fitted at the same height as the solebars.

Meaning: Because of design considerations these wagons must not pass through retarders or other types of shunting and stopping devices in active position.

5.4 Sign for wagons not to be loose-shunted

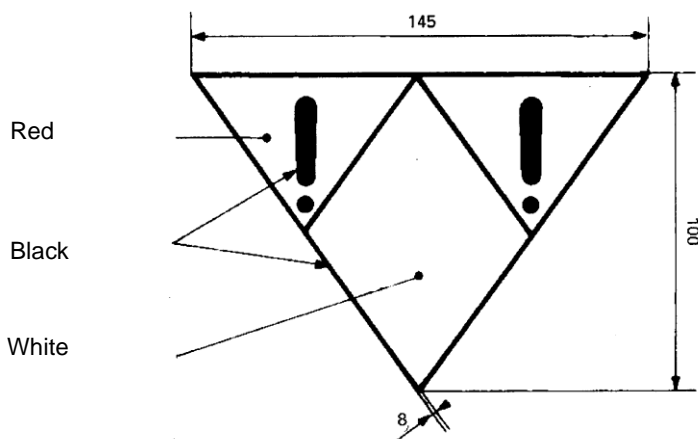

Position: On the left of each solebar, or on parts covering the solebar or on special boards fitted at the same height as the solebars.

Meaning: Special care should be taken when marshalling trains to avoid damaging the wagon. Wagon must not be loose-shunted and must be protected against buffing by other rolling stock without taking special precautions.

N.B.: This marking is compulsory on wagons with special fittings (electronic equipment, refrigerator units, etc.) for which normal buffing impacts are not authorised as they are liable to damage the equipment. These wagons may not carry the RIV sign but can be covered by bilateral agreements.

5.5 Sign for wagons that must not be fly- or gravity-shunted

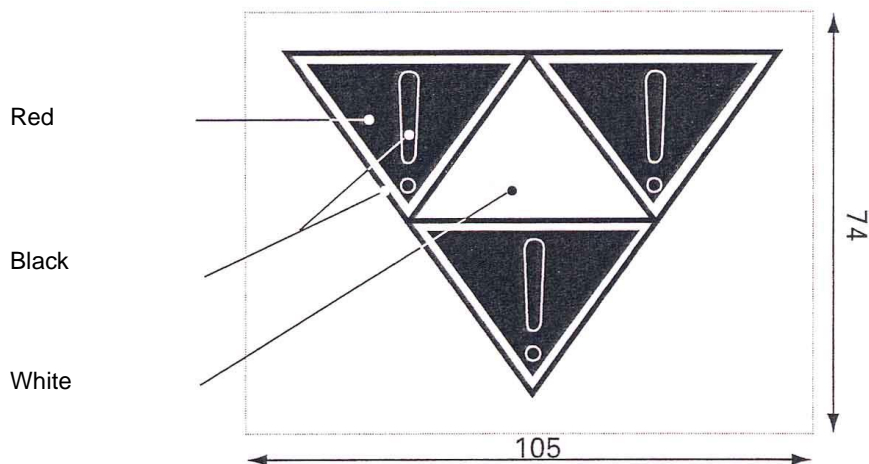

Position: On the left of each solebar, or on parts covering the solebar or on special boards fitted at the same height as the solebars.

Meaning: Wagon

- must not be fly- or gravity-shunted,
- must be marshalled by a motive power unit,
- must not be loose-shunted and must be protected against buffing by other rolling stock.

N.B.: Point 5.3.4.1 of the RID states that in place of the shunting label (shown in model 15) the wagon may instead carry permanent shunting signs (wagon markings) providing they conform precisely to the prescribed example.

5.6 Sign for fly and hump shunting not permitted for containers or loaded pocket wagons

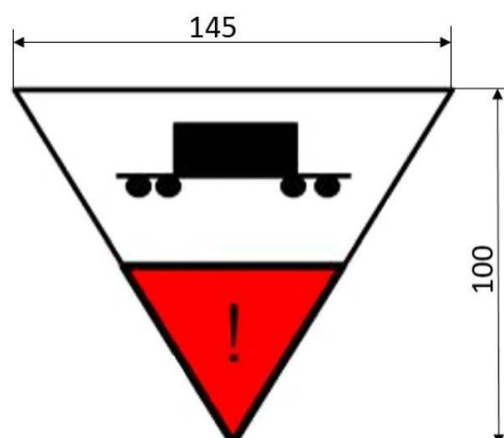

NB: Fly or hump shunting and buffing is not permitted when the wagon is loaded. Shunting may be performed without restriction when the wagon is empty.

5.6 Marking for wagons fitted with anti-crash components

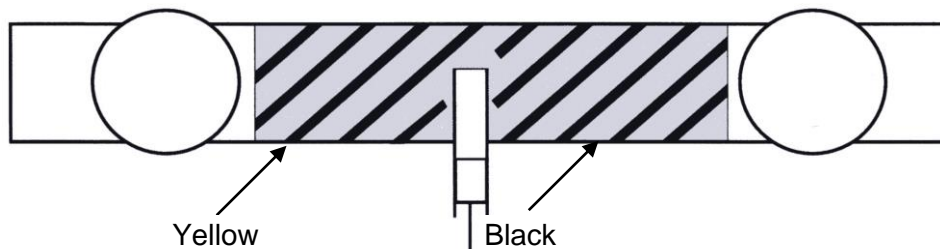

Position: On the headstocks, between the buffers.

Appearance: Paint: black diagonal warning stripes painted on a yellow background.

Meaning: Wagon fitted with anti-crash components. The Berne rectangle clearances may be encroached. Follow shunting instructions.

5.7 Marking for wagons fitted with long-stroke shock absorbers (schock absorber fitting)

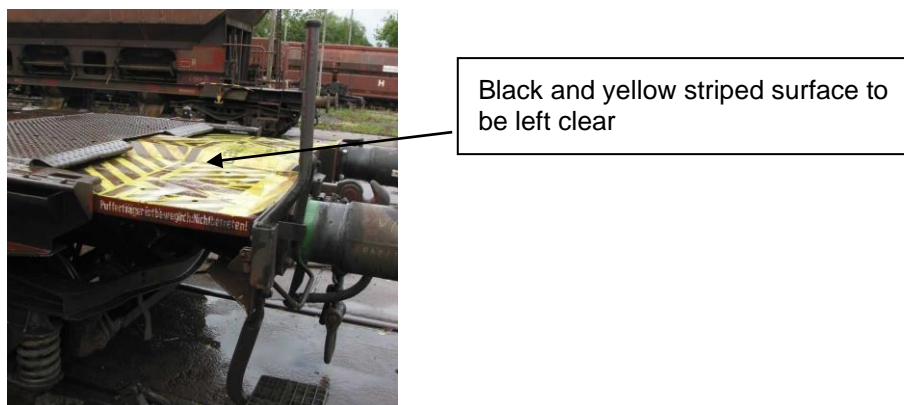

Position: Black diagonal warning stripes painted on a yellow background covering the danger areas for wagons fitted with shock absorbers.

Meaning: In the event of impact, the wagon ends become displaced in relation to the underframe. Distances and clearances are reduced as a result. Particular care must therefore be taken during shunting operations.

5.8 Marking for wagons fitted with projecting tow hooks

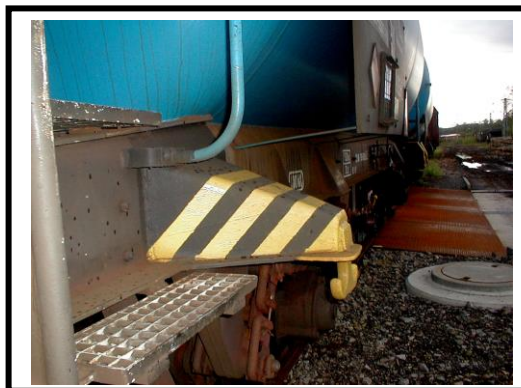
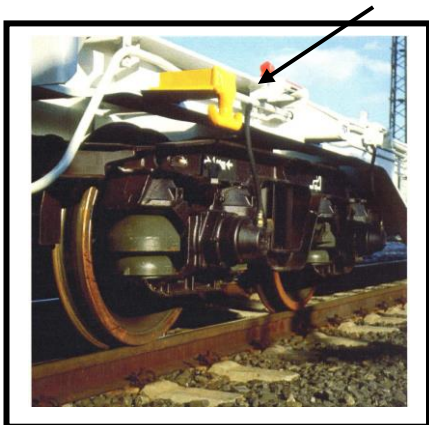

Position: Tow hooks and their fenders projecting more than 150 mm, and any supports and brackets, should be colour-marked as follows:

- Tow hooks and fenders: in yellow.

Colour-marking of tow hook supports and brackets:

- Projecting up to 250 mm: in yellow,
- Projecting more than 250 mm: black diagonal stripes on yellow background.

Meaning: Marking serving as a warning against the risk of injury.

5.9 Sign for permanently-coupled wagon units

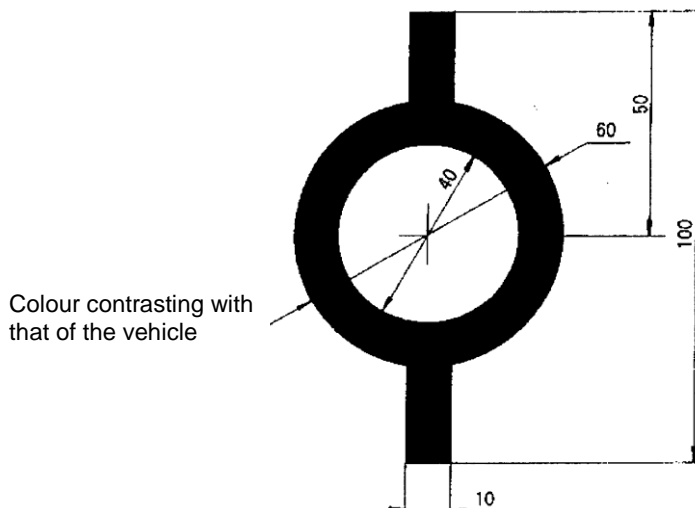

Position: On each headstock, next to the right-hand buffer.

Meaning: Not to be uncoupled in service. This sign is only used on wagons made up of several units that are permanently coupled together.

5.10 Sign for bogie wagons only able to negotiate curves with a radius greater than 35 m

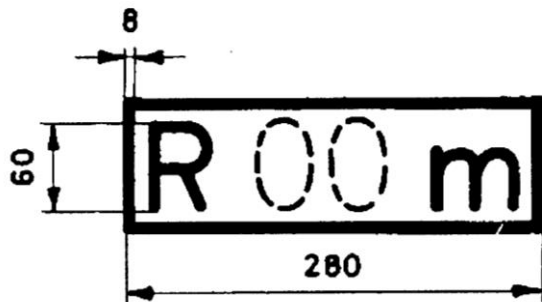

Position: On the left of each solebar, or on parts covering the solebar or on special boards fitted at the same height as the solebars.

Meaning: Indicates the minimum curve radius that the wagon can negotiate.

N.B.: On wagons with special fittings, for example low-loader wagons, this indication refers to the central position of the lateral sliding device and/or the maximum distance between bogie centres.

5.11 Signs indicating wagons fitted with a train line

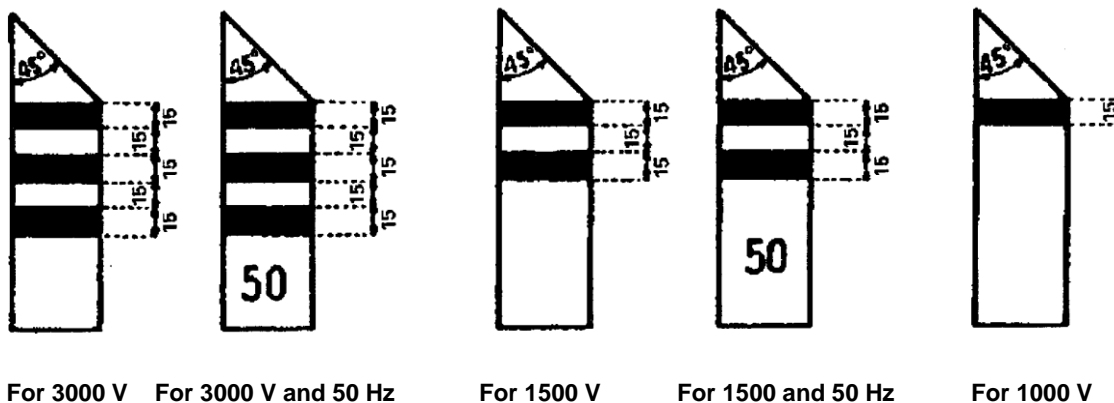

For 3000 V For 3000 V and 50 Hz For 1500 V For 1500 and 50 Hz For 1000 V

Position: On the lower part of the corner posts, on both outward-facing surfaces. For wagons without corner posts, it is recommended that the required markings be affixed to metal panels.

Appearance: Light yellow rectangle approx. 200 mm high, the same width as the corner post and with the top corner cut off at an angle of approx. 45° inclined downwards towards the centre of the wagon. Black horizontal stripes approx. 15 mm high are painted on the yellow rectangle at intervals of 15 mm.

Meaning: Wagon is fitted with a train line. One black stripe indicates a 1000 V DC cable, two stripes a 1500 V cable and three stripes a 3000 V cable. Approval for running on 50 Hz AC electrified networks is indicated by the number "50".

5.12 Sign for wagons fitted with the automatic coupler

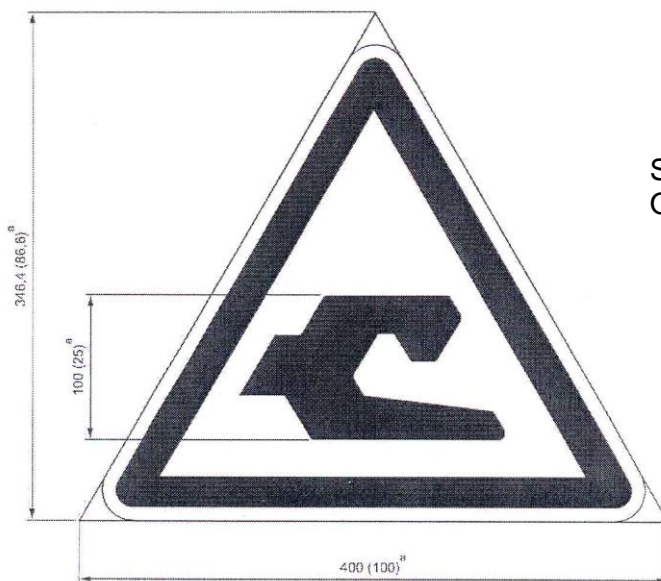

Sign according to OSJD* standard

Position: At each end of the wagon sides or solebar and on each end wall.

Meaning: Wagon fitted with automatic couplers.

N.B.: On wagons fitted with the automatic coupler, the Berne rectangle clearances may be partially encroached.

***OSJD:** Organisation for Collaboration between Railways, based in Warsaw.

5.13 Sign for derailment detectors

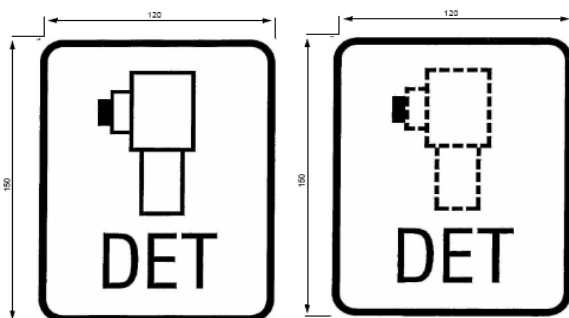

Position: On both sides of the wagon, when the derailment detector is visible. The picture on the sign has a dotted outline when the detector is not visible.

Meaning: Wagon derailment detectors are devices used to detect implausibly high vertical accelerations on the vehicle. A derailment is assumed to have taken place and an emergency brake application is triggered or an alarm sounded. The system cannot prevent a derailment itself from occurring.

5.14 Sign for strengthened screw coupling

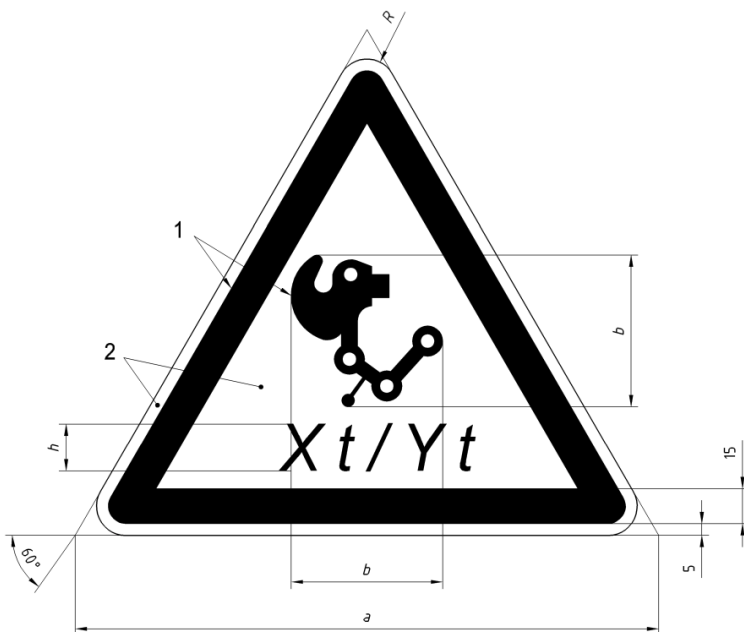

Key	1 Black
	2 Yellow

Taille	Dimensions			
	a	b	h	R
1	400	130	30	22
2	200	65	20	11

Position: At each extremity of the side faces of the wagon or on frame girder. This marking must be chosen according to the reserved space for that purpose.

Meaning: Wagon with strengthened screw coupling – X t is related to coupling resistance, Y t to coupling hook. A strengthened screw coupling is described in EN 15566:2009, paragraph 4.1, table 1. System’s recognition is over 1 MN.

– reserved –

6.1 Sign for wheels able to withstand high thermal stresses



Fig. 1

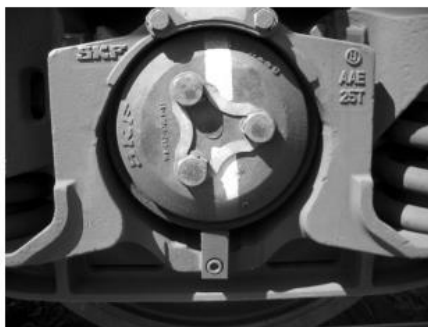
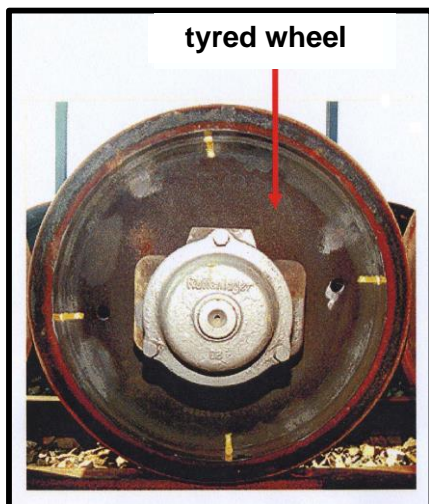

Fig. 2

- Position:** On the axle-box cover. (see Fig. 1)
On the axle box (see Fig. 2) for housing types without cover
- Meaning:** The axles in question have wheels that are able to withstand high thermal loading, in accordance with **UIC Leaflets 510-2** and **510-5**, Appendix H
- Remark:** It should be noted there are housings which, due to their design, do not have a cover. They can be recognizable by housing without holes for cover fastening

6.2 Marking of tyred wheels



- Position:** Four coloured stripes, at 90° intervals, on the outer surface of the wheel tyre and rim.
- Meaning:** Control mark to check the position of the tyre in relation to the wheel rim.

6.4 Sign for ventilation pipes

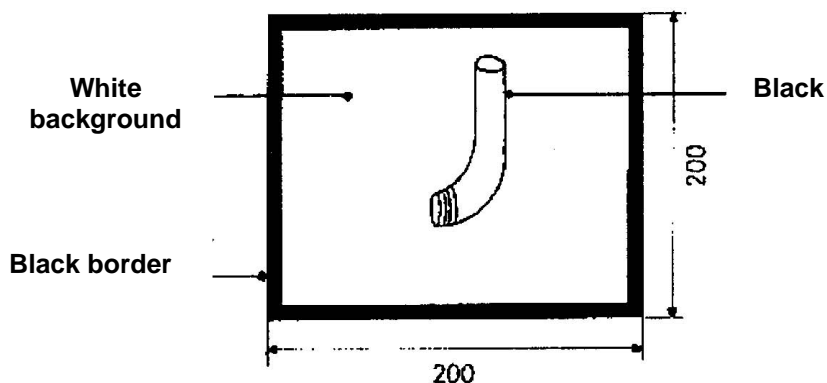

Position: On tanks, next to the pipes in question.

Meaning: The ventilation pipes marked with this symbol must no

6.5 Sign for tank wagon tests, coding of tanks and special regulations

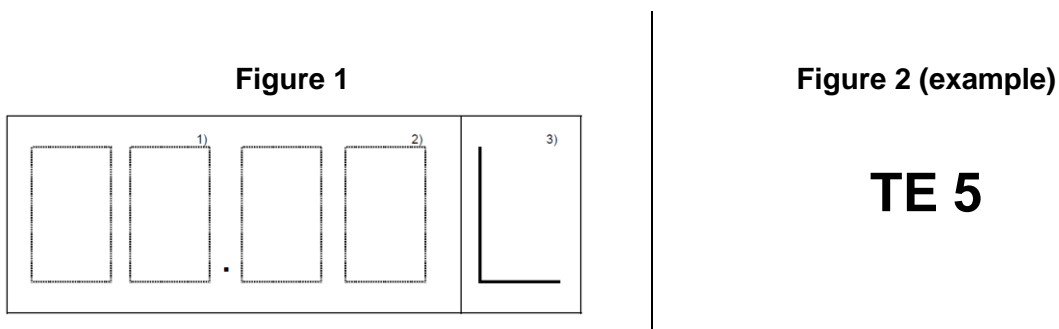

Position: On each side of each tank, on the right.

Meaning figure 1: Indication of the next tank test (end of month) for the carriage of dangerous goods in accordance with the RID. The marking specifies (1) the month (2) the year and if necessary the letter “L” as per RID 6.8.2.4.3.; 3) that the date of the next tank test is extended by 3 months.

Meaning figure 2: Example of an alphanumerical code for all the special regulations* applicable: here, the wagon is fitted with a highly flammable insulating material.

***N.B.:** The tank code should also be marked near the date of the tank test, in characters at least 90 mm high. The alphanumerical code for all applicable special regulations under the RID should also feature below the tank code or right beside it, in characters 50 mm high. This marking must be made by 1/1/2011 at the latest.

7.1 Sign indicating points for lifting the wagon body in the workshop

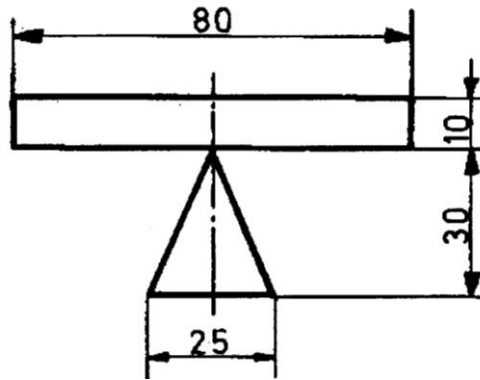

Position: At the designated points on the solebars

Meaning: Marking indicating where to place jacks, lifting devices, etc. in order to lift the whole of the wagon body.

7.2 Sign for lifting at 4 points with or without running gear

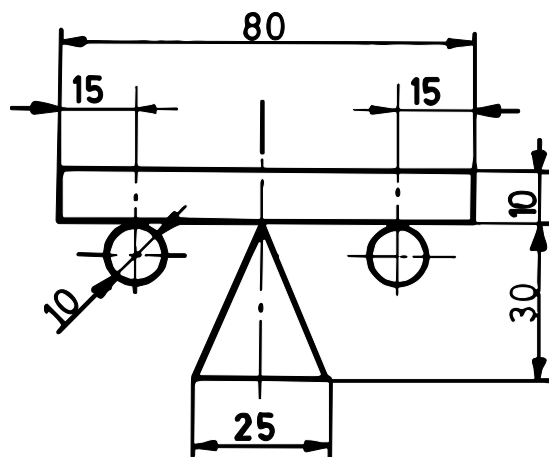

Position: At the designated points on the solebars.

Meaning: Marking indicating where to place jacks, lifting devices, etc. in order to lift the whole of the wagon body, including the running gear where appropriate.

7.3 Sign for lifting or re-railing with or without running gear at one end only or close to the end

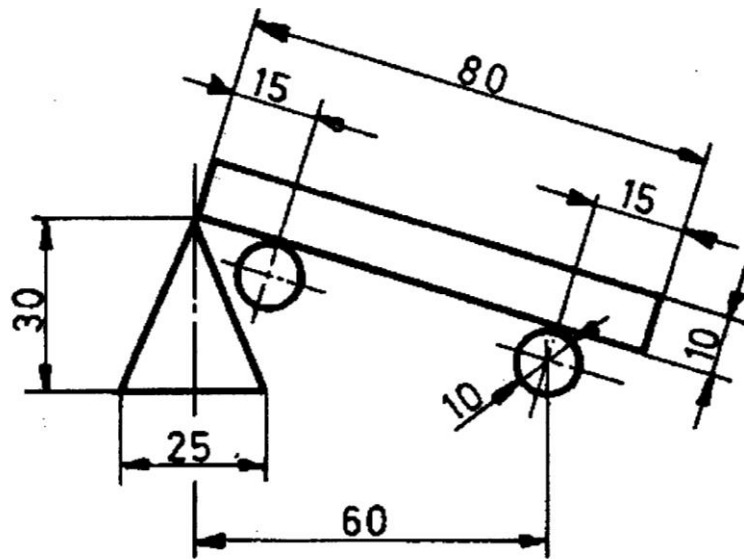

Position: At the designated points on the wagon headstocks or nearby.

Meaning: Marking indicating where to place jacks, lifting devices, etc. in order to lift the whole of the wagon body by one end, or close to the end, including the running gear where appropriate.

7.4 Sign for the replacement of springs

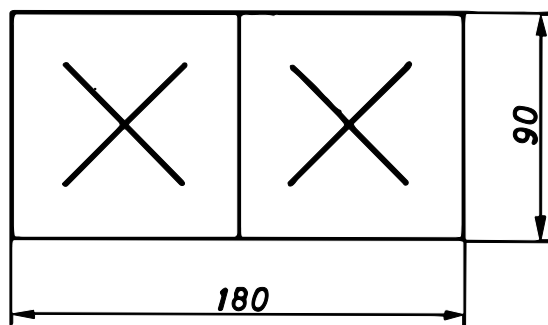

Position: On the right of each solebar, or on parts covering the solebar or on special boards fitted at the same height as the solebars.

Meaning: On wagons with a rigid underframe (tank wagons, hopper wagons, etc.), this sign indicates that if one spring is damaged, both springs must be replaced. This does not apply to suspension springs with progressive stiffness (e.g. parabolic springs). See also point 2.10, chapter A of Appendix 10.

7.5 Sign for wheel tyre inspection

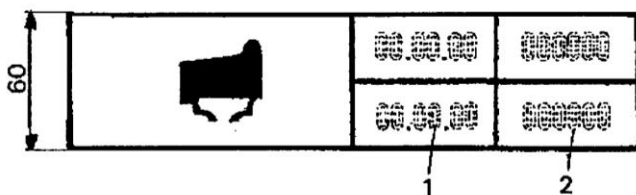
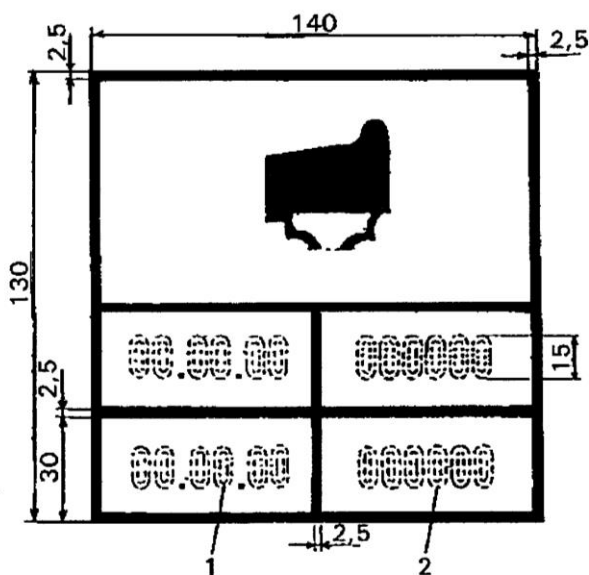

Position: On the right of each solebar, or on parts covering the solebar or on special boards fitted at the same height as the solebars.

Meaning: This plate indicates the date (day, month and year) (1) of the last two checks to ensure the tyre is firmly in place on the wheel body. In addition to the date, the initials of the RU and the code number of the workshop are also specified (2).

7.6 Sign for inspection periods for temperature controlled units



(Blue characters on a white background)

Position: On the right of each side wall, beneath the UIC or UIC St sign.

Meaning: On wagons used to carry perishable foodstuffs, this sign shows the distinguishing mark for the temperature control system under the ATP agreement and indicates the expiry date (month and year) of the certificate held by the wagon.

7.7 Sign for the protection of the inner lining of tank wagons

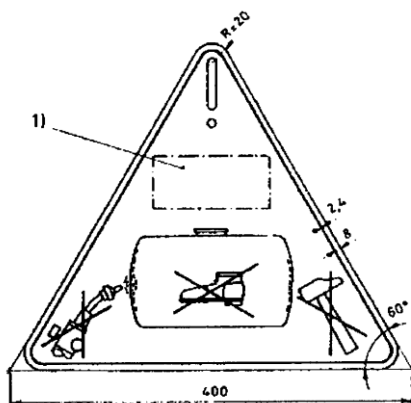

(Paint: Black outline and markings on a yellow background)

Position: On the tank at clearly visible points

Meaning: Precautions designed to protect the inner lining (enamel, coat of paint...).

N.B.: The words "inner lining" may be added to this pictogram in one or more languages.

7.8 Signs for privately-owned wagons, unified wagons, standard wagons

Figure 1 Sign for privately-owned wagons (registered with an RU before the GCU entered force)

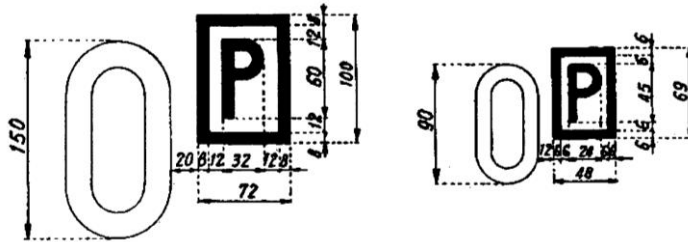

Position: On the left of each side wall, after the wagon self-check digit.
 Marking: if there is no room on the left, the name or company and initials of the wagon keeper may be marked on the right hand side.

Meaning: Privately-owned wagons, registered by their keepers with an RU. The keeper's name or company and initials should also be indicated (together with its fax number). This marking will be cancelled in the future.

Figure 2 Sign for unified wagons

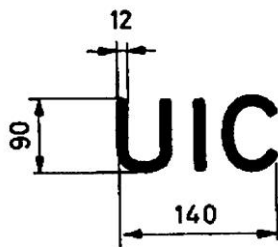

Position: On the right of each side wall.

Meaning: Wagon meeting standard international regulations (unified wagons).

Figure 3 Sign for standard wagons

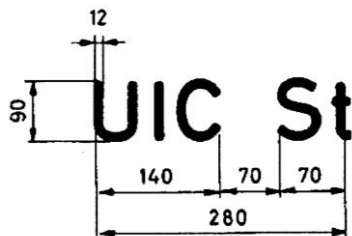

Position: On the right of each side wall.

Meaning: Only unified wagons built in accordance with ERRI drawings (standard wagons) may carry this marking.

7.9 Markings for certain spare parts

- 7.9.1 Standard screw couplers carry the "St" marking.
- 7.9.2 Wheelsets suitable for axle-loads of more than 20.0 tonnes carry the sign $2Q = 00,0\text{ t}$ indicating the permissible axle-load:
- on the identification ring for wheelsets fitted with a ring (collar) around the axle
 - on the inner face of the wheel hub for wheelsets without an identification ring
- 7.9.3 Suspension leaf springs suitable for axle-loads of more than 20.0 tonnes carry the sign $2Q = 00,0\text{ t}$ on the shackle, indicating the permissible axle-load.
- 7.9.4 When welding or heating work on or near the wagon buffers can constitute an accident hazard, a yellow disc of 50 mm diameter should be painted on the buffer casing.
- 7.9.5 For standard buffers with a stroke of 105 mm, the sign 105 – X shall be marked on the buffer casing the owner's mark to indicate the buffer stroke and buffer category (A, B or C) as defined in the UIC Code. Buffers manufactured before 1/1/1981 that do not meet the conditions of category A do not feature the category letter.

8.1 Signs for high voltage warning sign (lightning flash)

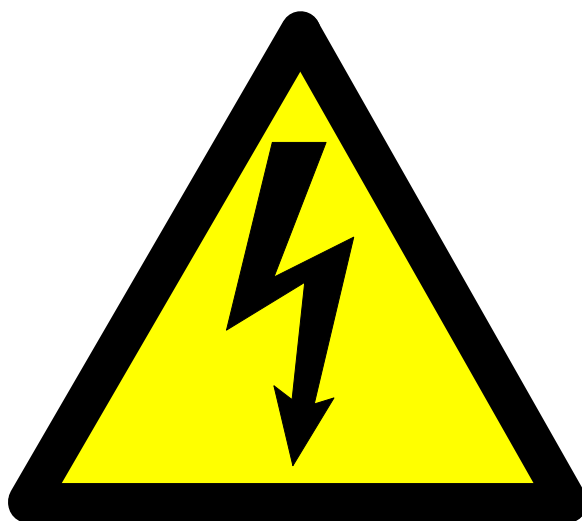

Position: On wagons fitted with steps or ladders, in the immediate vicinity of these fittings and at a height such that the sign is visible before the danger zone is reached. For use on wagons where the top step or upper part of the ladder is more than 2000 mm above rail level.

Meaning: Warning against high voltage. Stop! You are entering a particularly dangerous area. Only duly authorised personnel may work in this area having first taken the necessary precautions.

N.B.: The size of the sign will depend on where it is to be placed.

8.2 Signs for high voltage warning sign (Stop!)



Position: On wagons with steps or ladders, in the immediate vicinity of these fittings and at a height such that the sign is visible before the danger zone is reached. For use on wagons where the top step or upper part of the ladder is more than 2.0 m above rail level, or whose design enables them to be climbed.

This pictogram may be shown on a rectangular blue background measuring 400 mm x 220 mm.

Meaning: Warning - high voltage. Stop! You are entering a particularly dangerous area. Only duly authorised personnel may work in this area having first taken the necessary precautions.

Remark: This marking is mandatory as of 1/1/2021

Explanation This pictogram is intended to warn inspection personnel and unauthorised third parties of the risk of high voltage on the wagon.

Wagons whose design enables them to be climbed fulfil two criteria:

1. The external part of the end walls is fitted with horizontal elements with a maximum vertical distance of 45 cm.
2. These elements must be at least 5 cm in depth or must be comparable to steps of a ladder.

If both criteria are fulfilled, the pictogram in 8.2, "Signs for high voltage warning sign (Stop!)" must be affixed, but the pictogram in 8.1, "Sign for high voltage warning sign (lightning flash)" is not required.

Both warning pictograms (8.1 and 8.2) must be affixed on wagons equipped with ladders and steps.

APPENDIX 12 TO THE GENERAL CONTRACT OF USE

CATALOGUE OF DAMAGE TO WAGONS

Category	Part	Type of damage	Additional information	Responsibility of	
				Keeper	User RU
Running gear					
	Wheelset		Inspection in accordance with Appendix 10, Annex 3 EUROPEAN VISUAL INSPECTION CATALOGUE (EVIC) FOR FREIGHT WAGON AXLES, including replacement of the wheelsets	X	
	Tyred wheel	Tyre lose, laterally displaces, cracked	No sign of thermal overloading	X	
			Visible signs of thermal overloading (brake equipment faulty)	X	
			Visible signs of thermal overloading (brake equip. operational)		X
	Tyre / wheel centre / solid wheel / wheel tread	Thermal overloading	Brake equipment faulty	X	
			Braking equipment operational		X
		Cracks in the disc	No sign of thermal overloading	X	
			Visible signs of thermal overloading (brake equipment faulty)	X	
			Visible signs of thermal overloading (brake equipment operational)		X
		Clamping notches		X	
		Measuring circle not visible	Excessive wear of wheel centre (diameter too small)	X	
		Damage from track brakes	Notches with sharp-angled apex in the tyre and the rim or the lower rim of the tyre		X
		Traces of abrasion, flanges damaged	Accidental damage ¹⁾		X
		Cavity, shelling or flaking	Not including thermal overloading	X	
	Metal inclusions, flats	Brake equipment faulty	X		
		Brake equipment operational		X	
	Occasional dents in wheel tread	Accidental damage ¹⁾		X	
	Out-of-roundness			X	
			If the damage can be clearly attributed to the RU		X
	Axle shaft	Traces of abrasion on the axle shaft	Damage to wagon	X	
No damage to wagon				X	
Bent out of shape Cracks				X	
Axle-boxes	Hot axle-box	Confirmed	X		
		Not confirmed		X	
	Recent leakage of lubricant	High Axle-box temperatures, abnormal noises in the box when the axle rotates	X		
	Traces of contact on the axle-box housing (top-contact with bogies)	Suspension and dampers in good condition and wagon not overloaded		X	
Manganese plates	Missing		X		
	Cracked weld beads		X		

¹⁾Accidental damage in the sense of Appendix 12 is understood as damage not resulting from wear but either from inappropriate handling of the wagon (e.g. shunting accidents, side- on collisions or other sudden events), or which can be attributed to culpable violation of wagon custody obligations by an RU.

Category	Part	Type of damage	Additional information	Responsibility of	
				Keeper	User RU
Suspension					
	Springs	Ruptured, cracked, etc.		X	
		Fatigued		X	
		Wrongly fitted (parallel)		X	
		Wrongly fitted (characteristic curve) or wrong type of leaf spring		X	
	Friction damper	Any type of damage		X	
Brake					
	Mechanical and pneumatic brake parts	Defective brake rigging	Accidental damage ¹⁾		X
			Wear	X	
		Defective changeover device	Accidental damage ¹⁾		X
			Wear	X	
		Defective hand brake		X	
		Brake blocks (all types of damage)		X	
		Defective hand brake	Accidental damage ¹⁾		X
			Wear	X	
		Safety stirrup missing		X	
		Safety stirrup damaged or defective	Accidental damage ¹⁾		X
		Other brake parts defective (e.g. distributor, load-weigh valve, brake cylinder, changeover device, relay valve, etc.)	Confirmed (brake report included)	X	
			Not confirmed		X
		Brake pipe leaking	Wear	X	
			Accidental damage ¹⁾ (distorted, cracked)		X
		Defective brake hose	cracked, leaking	X	
Defective brake connection		X			
Defective air brake parts	Confirmed by brake test	X			
	Not confirmed by brake test		X		

1) Accidental damage in the sense of Appendix 12 is understood as damage not resulting from wear but either from inappropriate handling of the wagon (e.g. shunting accidents, side-on collisions or other sudden events), or which can be attributed to culpable violation of wagon custody obligations by an RU.

Category	Part	Type of damage	Additional information	Responsibility of	
				Keeper	User RU
Underframe and bogie					
	Wagon underframe	Fatigue cracks, fissuring		X	
	Headstock or solebar	Deformed	Except traces of fatigue		X
	Axle guard	Deformed			X
		Broken or loose		X	
	Axle guard tie bar	Bent or broken			X
		Loose		X	
	Suspension bracket	Loose, fatigue cracking		X	
		Fissured, deformed	Accidental damage ¹⁾		X
	Underframe / bogie connection	Connecting parts loose or damaged		X	
	Bogie frame	Deformed			X
		Fatigue cracks		X	
	Bogie side bearers	Any type of damage		X	
	Overhaul plate	Vehicle erroneously removed from service before expiry of overhaul period	Costs for authorisation to run / special consignment		X
	General markings as required by law	Incomplete		X	
		Illegible	E.g. because of projecting load, papered over, graffiti, etc.	X	
			Graffiti on RID dangerous goods wagon		X
	Earthing cable	Missing			X
		Damaged	Wear	X	

Category	Part	Type of damage	Additional information	Responsibility of	
				Keeper	User RU
Buffing and draw gear					
	Buffer	Different types	Not previously changed by an RU	X	
		Buffer position not within tolerance range / Plunger stuck	Traces of impact (contact between plunger and sleeve) Old cracks and / or welds	X	X
	Anti-crash device	Defective	hunting impacts at too high speeds		X
			Normal wear	X	
	Buffer head	Broke or distorted			X
	Buffer sleeve	Broken or cracked	Normal wear	X	
			Result of force ¹⁾		X
	Buffer fastening	Loosened	Normal wear	X	
		Broken	No fatigue cracks		X
	Buffer spring	Ineffective	Can be compressed by hand	X	
	Draw hook / draw bar	Broken	Fatigue (old crack)	X	
			Accidental damage ¹⁾ (clean recent breakage)		X
			Twisted		X
	Drawgear	Torn out	Accidental damage ¹⁾		X
Screw coupler	Wear		X		
		Accidental damage ¹⁾		X	
Screw coupling dummy hook	Twisted, broken			X	
Superstructure					
	In general	Wear and tear		X	
		Accidental damage ¹⁾ when in the custody of the			X
	Ladders, walkways, steps, towing rings, handrails, label-holders	Wear		X	
			Accidental damage ¹⁾ when in the custody of the		X
	Tank	Damage resulting from damaged underframe	Accidental damage ¹⁾ when in the custody of the RU		X
		Damage to the tank	Accidental damage ¹⁾ when in the custody of the RU		X
		Bracing / sealing caps not air / waterlight	Accidental damage ¹⁾ when in the custody of the RU		X
		Tank cradle cracked		X	
	Earthing cable (on the tank)	Missing, damaged	Accidental damage ¹⁾ when in the custody of the RU		x
			Wear	X	

¹⁾ Accidental damage in the sense of Appendix 12 is understood as damage not resulting from wear but either from inappropriate handling of the wagon (e.g. shunting accidents, side-on collisions or other sudden events), or which can be attributed to culpable violation of wagon custody obligations by an RU

APPENDIX 13 TO THE GENERAL CONTRACT OF USE

LIST OF REPAIRS WHICH MAY BE CARRIED OUT BY THE RU ON THE PLACE OF IMMOBILIZATION OF THE WAGON OR IN THE NEARBY VICINITY

The application of appendix 13 is neither mandatory for the RU nor may its application be demanded by the Keeper.

This list contains repair works to re-establish the running order in the scope of article 19 which may be carried out by the RU without the prior agreement of the keeper irrespective of the amount of the related costs.

If the listed repair works are not carried out on the spot where the wagon has been immobilized or in the very nearby vicinity by the operating staff, inspectors, mobile units, etc., the RU will sent the wagon to a workshop. In this case, the regular procedure of article 19.1 will be applied.

If appendix 13 is applied, the provisions set out in article 19.5 have to be complied with for the re-establishment of the running order of the wagon.

List:

Code Code Code	Anomalie Mängel Irregularities
3.1.1	Organe mécanique ou pièce de timonerie décroché(e) ou cassé(e) Herunterhängde oder gebrochene Teile des Bremsgestänges Part of brake rigging hanging down or broken
3.1.2	Etrier de sécurité du triangle de frein inefficace Fangeinrichtung unwirksam Safety strap ineffective
3.1.3	Robinet d'isolement du frein Bremsabsperrhahn Brake isolating cock
3.1.3.2	position pas nette Stellung nicht eindeutig position unclear
3.3.2.1	Demi-accouplement avarié manquant Bremskupplungen schadhaft, fehlen Brake coupling damaged or missing
3.3.5.1	Robinet d'arrêt d'air, inutilisable, non étanche, forcé, poignée manquante Luftabsperrhahn nicht gangbar, undicht, verbogen, fehlender Griff Stopcock, unusable, leaking, warped or handle missing

Code Code Code	Anomalie Mängel Irregularities
5.2.3	Plateau de tampon - Surface de contact Pufferteller - Berührungsfläche Buffer head - Contact surfaces
5.4.4	Fixation défectueuse Befestigung nicht sichergestellt Fastening defective
5.4.4.1	2 boulons ou plus desserrés 2 oder mehr Schrauben lose 2 or more bolts loose
5.4.4.2	1 boulon manquant 1 Schraube fehlt 1 bolt missing
5.4.4.3	1 boulon desserré 1 Schraube lose 1 bolt loose
5.6	Tendeur d'attelage Schraubenkupplung Screw, coupler
5.6.1	Partie manquante, avariée ou inutilisable Teil fehlt, ist beschädigt oder unbenutzbar Part missing, damaged, or inoperative
5.6.3	Tendeur décroché Herabhängende Kupplung Coupler unhooked
5.8	Autres organes de traction Andere Teile der Zugeinrichtung Other draw gear parts
5.9	Amortisseur à longue course Langhubstoßdämpfer Long-stroke damper
6.1.1	Marques et inscriptions manquantes, illisibles ou incomplètes Anschriften fehlen, nicht lesbar oder unvollständig Markings on wagons and load units, missing, illegible or incomplete
6.1.7.4	Poignées: absentes, avarie qui met en danger la sécurité du personnel, arrachées ou déformation hors tolérance Griffe: fehlen, Schaden der die Sicherheit des Personals gefährdet, angerissen oder unzulässig verbogen Handles: missing, damage representing a safety hazard for staff, torn off or deformed beyond tolerated limit
6.1.7.5	Tôles : inscription, rabatables; portes étiquettes - Fixation insuffisante Ungenügende Befestigung der Anschriftentafeln, Klapptafeln, Zettelhalter Inadequate securing of inscription plates, folding plates, label holders
6.1.7.6	Tôles : inscription, rabatables; portes étiquettes - Absence Fehlen der Anschriftentafeln, Klapptafeln, Zettelhalter Missing: inscription plates, folding plates, label holders
6.1.7.8	Accessoires amovibles non assurés Lose Wagenbestandteile nicht gesichert Loose wagon accessories not secured

APPENDIX 14

TO THE GENERAL CONTRACT OF USE FOR WAGONS

**ADDITIONAL CONDITIONS FOR THE USE OF WAGONS ON FERRIES AND IN EXCHANGE WITH
RAILWAYS OPERATING ON
STANDARD OR BROAD GAUGE LINES**

A – CONDITIONS TO BE MET FOR THE CONVEYANCE OF WAGONS ON FERRIES**Group 1**RUs operating train ferry services:

DB Schenker Rail Deutschland AG (DBSR)
DB Schenker Rail Dänemark (DBSR)
Green Cargo (GC)
Polish State Railways S.A. (PKP)
TRENITALIA S.P.A. (FS)
Romanian Railways (CFR)

Routes:

Trelleborg-Sassnitz ferry port (GC/DBSR)
Trelleborg-Rostock Port ferry terminal (GC/DBSR)
Swinoujscie-Ystad (PKP/GC)
Constanta-Samsun (CFR/TCDD)
Reggio Calabria-Messina (FS)
Villa S. Giovanni-Messina (FS)
Civitavecchia-Golfo Aranci (FS)

Conditions to be met by

- 1 Two-axle wagons:**
No restrictions apply.
- 2 Three-axle wagons:**
Three-axle wagons will only be taken on board ferries when the water level permits.
They must be able to negotiate the curves on board the ships (see list of routes for groups 1 and 2).
- 3 Bogie wagons suitable for unrestricted conveyance by ferry:**
Wagons with two- or three-axle bogies are accepted without restriction provided they are able to negotiate both the maximum ferry ramp angle and the on-board curves (see Appendix 11, points 5.10 and 2.12 and the list of routes in groups 1 and 2).
- 4 Other bogie wagons and shipments carried on more than one wagon or with a buffer wagon:**
Wagons with two- or three-axle bogies that do not meet the conditions set out above, as well as wagons with bogies that have more than three axles and shipments that must be carried on more than one wagon (loads carried on two wagons coupled together or with a buffer wagon) may only be taken on board by special agreement and if the water level permits.
It is the responsibility of the forwarding RU to make the necessary arrangements with the RUs involved in operating the ferry. The other RUs on the wagon's route must be advised of the authorisation obtained by an indication to this effect in the accompanying documentation.

Group 2

RUs operating train ferry services:

Turkish State Railways (TCDD)

Routes:

Sirkeci-Haydarpasa

Tatvan-Van

No restrictions apply.

List of train ferry routes in Groups 1 and 2

Wagons that can be accepted without special arrangement must be able to negotiate the curves and angles indicated for the ferries operating each of the respective routes.

Route	Number of tracks on the ferry	Curve and counter-curve			Maximum ramp angle in relation to the horizontal α	Observations
		Radius in m	Length of transition section in m	Radius in m		
1	2	3	4	5	6	7
Trelleberg-Sassnitz ferry port	5 6 8	150	0	140*	2°30'	
Trelleberg-Rostock Port	5 6 8	150	0	140*	2°30'	
Swinoujscie-Ystadt	4	—	—	—	2°30'	
Constanta-Samsun	5+1	120	2.5	120	1°30'	
Reggio Calabria-Messina	3	150	15.5	150	1°30'	
Villa S. Giovanni-Messina	3 4	150 120	15.5 19.6	150 120	1°30'	
Civitavecchia-Golfo Aranci	3	—	—	—	1°30'	
Sirkeci-Haydarpasa	3	—	—	—	—	
Tatvan-Van	2 1	120 —	— —	120 —	—	

Groupe 3**Train ferry routes between standard gauge RUs and Finland:**

Lübeck-Skandinavienkai (Germany) – Turku (Finland)¹⁾

Wagons that can be accepted without special arrangement must be able to negotiate the curves and angles indicated for the ferries operating each of the respective routes.

Route	Number of tracks on the ferry	Curve and counter-curve			Maximum ramp angle in relation to the horizontal α	Observations
		Radius in m	Length of transition section in m	Radius in m		
1	2	3	4	5	6	7
Lübeck-Skandinavienka – Turku	2	150	6	100	2°30'	
	2	150	6	100	2°30'	
	1	—	—	—	2°30'	
Rules governing the reciprocal use of wagons in traffic with Finland are set out in part C below						

¹⁾ Open as a CIM line only for international shipments of large containers and swap bodies.

B – RULES GOVERNING THE USE OF WAGONS WITH INTERCHANGEABLE AXLES IN TRAFFIC ACROSS THE PYRENEES

1 General

1.1 The provisions of the GCU apply to wagons with interchangeable axles unless otherwise specified in this Appendix.

1.2 In the following text, “wheelsets” refer to both wheelsets on standard gauge lines and on broad gauge lines.

1.3 This appendix specifies the conditions for exchange of wagons whose wheelsets are interchangeable between an RU certified in France and an RU certified in Spain where the parties have concluded an agreement for exchange of wagons with interchangeable wheelsets at a station on the French-Spanish border that has a wheelset changing facility.

1.4 The transferee RU shall be responsible for changing the wheelsets on wagons accepted for exchange in specialist facilities, or for ensuring that the wheelsets are changed.

1.5 It is incumbent upon the keeper of the wagon suitable for traffic across the Pyrenees to supply wheelsets for each type of gauge.

1.6 Because of the conditions prevailing at wheelset changing facilities, the only vehicles that can be accepted for exchange between RUs are wagons with interchangeable axles or bogie wagons with interchangeable axles for which the owner RUs or keepers have concluded a prior agreement with the wheelset changing facility or facilities concerned. This prior agreement must, in particular, define the conditions governing the supply of the axles.

1.7 Failing such prior agreement wagons used on standard or broad gauge lines are subject to the general conditions applicable to wagons not for variable gauge service.

1.8 For transport and storage of wheelsets in the wheelset changing facility the provisions of Appendix 10, Annex D apply.

2 Additional technical conditions

2.1 In accordance with ECM requirements, taking into account their specific uses and loads, the keeper must perform an overhaul of the interchangeable wheelset or arrange for the overhaul to be performed in a manner that fulfils its obligations as described in Article 7 of the GCU.

2.1.1 The date of the last overhaul of the wheelset, the code number of the keeper and the identification mark of the workshop that carried out the overhaul are to be indicated on a loose collar attached to the axle body or on a plate affixed to the axle-box.

2.1.2 The wheelsets must also bear the keeper's code number and the date (month and year) of expiry of the last overhaul on the front of each axle-box, painted in white and clearly visible.

2.2 When the date of expiry of the last overhaul has passed (last day of the month indicated) or is illegible, when determined during the special technical acceptance inspection performed by the transferee RU when leaving the wheelset changing facility at an exchange station, or when determined by a user RU, the wagon must be immobilised (**removed**).

2.3 If the marking on the axle-boxes is illegible, missing or erased on one side, the wagon must be withdrawn from service (**K label**); if the marking is illegible, missing or erased on both sides, the wagon must be immobilised (**removed**).

2.4 To be admitted for exchange with a change of wheelsets for traffic across the Pyrenees, the wagons must:

- be marked with the **E** sign on each side wall in accordance with Appendix 11 to the GCU (point 2.16)
- have a minimum distance of 1,840 mm and a maximum distance of 1,860 mm between the centres of the buffer rods or guides

3 Exchange of wagons with a change of wheelsets at the France-Spain border

3.1 Custody of the wagons with interchangeable wheelsets is transferred from the transferor RU to the transferee RU when the wagons arrive at the wheelset changeover facility.

3.2 For changes of wheelsets, the technical transfer inspection consists of:

- performance prior to the wheelset changeover of a technical handover inspection (THI) conducted by the transferor RU;
- performance after the wheelset changeover of a special technical acceptance inspection by the transferee RU, during which the parts of the wagon affected by the wheelset changeover are subject to particular attention.

Exchange of wagons between the two RUs within the framework of a quality assurance agreement is not permitted.

The other points contained in Appendix 9 to the GCU shall apply.

3.2 At the changeover point, wagons should be fitted with wheelsets belonging to the keeper.

3.3 Wheelset changeover may not be used to justify a request for the wagon to be weighed at the changing point.

3.4 Instead of the wheelsets being changed, the wagon load must be transhipped in the following cases:

3.4.1 if the wagon used is unfit to continue its run beyond the changeover point,

3.4.2 if the wheelsets on the transferee RU's gauge are missing,

3.4.3 if the available capacity at the wheelset changeover point is exceeded,

3.4.4 if the wheelset changeover facility is inoperable.

3.5 The cost of the transhipment operation shall be borne as follows:

- case described in point 3.4.1: by the RU responsible for use of the wagon when it is not suitable for traffic across the Pyrenees,
- case described in point 3.4.2: by the keeper,

- Case described in points 3.4.3 and 3.4.4: by the RU which should normally conduct the changeover operation if it failed to report the problem in accordance with Article 11 of the GCU.

3.6 The transferee RU must monitor wheelset changeover operations from the perspective of operating safety.

4 Cost of wheelset changeover and supply at France-Spain exchange stations

The costs associated with the wheelset changeover operation shall be covered by a flat-rate tariff charge payable to the transferee RU.

These costs do not include fees for supply of wheelsets, which are borne directly by the keeper or by the entitled party.

5 Return of empty wagons

Unless otherwise specified, empty wagons must be returned home via the same exchange station as that at which the wheelsets were changed on the outward run.

6 Temporary suspension of the use of wagons traffic across the Pyrenees

6.1 The keeper of a wagon suitable for traffic across the Pyrenees in accordance with may decide to use it solely subject to the conditions applicable to wagons not suitable for changing wheelsets, only on standard or broad-gauge lines, subject to the conditions applicable to wagons not suitable for changing wheelsets.

6.2 The conditions of preventive maintenance for these wagons may consequently be revised at the decision of the keeper.

6.3 Wagons of this nature are identified on the basis of additional markings and wheelset overhaul markings as provided for in point 2 of this Appendix, permanently affixed to each wall of the wagon, and wheelsets marked with a green saltire.

6.4 The keeper decides on resuming use with a change of wheelsets of a wagon suspended in accordance with the conditions of the present article for traffic across the Pyrenees, provided that:

- the prescribed markings have been affixed to the wagons and wheelsets,
- the wheelsets have been overhauled in accordance with point 2 of this Appendix.

C - RULES GOVERNING THE RECIPROCAL USE OF WAGONS WITH INTERCHANGEABLE¹⁾ AXLES (FOR INDIVIDUAL AXLE WAGONS) OR BOGIES²⁾ (FOR BOGIE WAGONS) IN TRAFFIC WITH FINLAND**1 General**

- 1.1 The provisions of the GCU shall apply to wagons with interchangeable axles unless otherwise stipulated in this Annex.
- 1.2 Because of the conditions prevailing at the Tornio (Finland) wheelset/bogie changeover facility, only wagons for which the keeper has concluded a prior agreement with a Finnish RU operating the facility or on whose behalf it is operated can be accepted for exchange between Sweden and Finland and vice-versa.
This prior agreement must, in particular, define the conditions governing the changing and supply of the axles.

2 Additional technical conditions

- 2.1 If the overhaul period for an interchangeable wheelset has been exceeded by more than 3 months, the wheelset is to be regarded as damaged and must be replaced.
- 2.2 If the overhaul period for an interchangeable bogie has been exceeded by more than 3 months, the keeper shall be informed and asked for instructions. **K labels** shall be affixed to the wagon, deleting the words "after unloading to be repaired".
- 2.3 The distance between buffer centres must be:
- maximum 1,800 mm,
 - minimum 1,780 mm.
- However, for wagons built before 1.7.1984, a buffer centre distance of between 1,760 mm and 1,740 mm is acceptable.

3 Changeover of wheelsets or bogies

- 3.1 The keeper of the wagon, in agreement with the Finnish RU involved, shall ensure that the interchangeable wheelsets or bogies are available as required at Tornio. The detailed arrangements shall be set out in the agreement to be concluded in accordance with point 1.2 of this Appendix.
- 3.2 As a rule, the Finnish RU involved shall be responsible for conducting the wheelset or bogie changeover operation in Tornio.
In cases where the Finnish RU involved does not itself carry out the changeover, it shall inspect the operation from the point of view of operating safety exclusively.
- 3.3 Wheelset or bogie changeover may not be used to justify a request for the wagon to be weighed at Tornio.

¹⁾ In the text that follows, the term "wheelset" is used to refer to both standard gauge and broad gauge equipment.

²⁾ In the text that follows, the terms "wheelset" and "bogie" are used to refer to both standard gauge and broad gauge equipment.

3.4 Instead of the wheelsets or bogies being changed, the load itself must be transhipped in the following cases:

3.4.1 if the wagon used is unfit to continue its run beyond Tornio,

3.4.2 if the wheelsets or bogies are missing,

3.4.3 if the available capacity at the wheelset/bogie changeover point in Tornio is exceeded,

3.4.4 if the wheelset/bogie changeover facility is inoperable.

3.5 The cost of the transshipment operation shall be borne as follows:

- case described in point 3.4.1: by the RU responsible,
- case described in point 3.4.2: by the keeper,
- case described in points 3.4.3 and 3.4.4: by the Finnish RU involved if it failed to report the problem in accordance with Article 11 of the GCU.

4 Cost of wheelset and bogie changeover and supply at Tornio

The costs associated with wheelset and bogie changeover operations shall be covered by a flat-rate charge for each wagon submitted for changeover, payable to the Finnish RU involved. These charges shall be brought to account through the usual tariff mechanisms.

5 Additional wagon markings

5.1 All wagons must be marked on the right of each side wall (or on the right of each solebar for flat wagons) with the **E** sign shown in **point 2.16 of Appendix 11** (Finland) which certifies that they meet the constructional provisions of **UIC Leaflet 430-3** and are accepted for traffic with Finland.

5.2 Wagons with interchangeable axles (axle wagons) must also carry the following additional marking near to the overhaul markings, in the language of the RU with which the wagon keeper has concluded a service agreement, and in Finnish:

"Observe axle overhaul markings"

"Huomi Pyöräkerran korjausmerkintä".

5.3 Wagons with interchangeable bogies (bogie wagons) must also carry the following additional marking near to the overhaul markings, in the language of the RU with which the wagon keeper has concluded a service agreement, and in Finnish:

"Observe bogie overhaul markings"

"Huom! Telin korjausmerkintä".

5.4 Interchangeable axles must be permanently marked on each axle-box with the code number or initials of the RU with which the keeper has concluded a service agreement, as well as the overhaul period and date (month and year) of their last overhaul.

5.5 Interchangeable bogies must be clearly marked on the solebar in white paint with the code number or initials of the RU with which the keeper has concluded a service agreement, the keeper's identification mark, as well as the overhaul markings described in **point 2.3 of Appendix 11**.

1 Reserved

APPENDIX 15
TO THE GENERAL CONTRACT OF USE FOR WAGONS

WAGON PERFORMANCE MESSAGE (WPM)

Appendix 15 describes in more detail the information-related requirements laid out in article 15.

In accordance with pages 3-4, the user RU must send the Wagon Performance Message to the wagon keeper for all wagons registered in the GCU database.

The user RU must send the complete set of wagon performance data for the entire custody period of a wagon in accordance with GCU Article 1.4. The wagon performance data must be sent to the keeper by the end of the month at the latest for each period of custody concluded in the previous month. Wagon performance data for multiple wagons may be contained in a single Wagon Performance Message.

Should the user RU transfer a wagon to a third-party RU in accordance with GCU article 16, the last user RU which is a GCU signatory remains responsible for submitting the complete Wagon Performance Message on behalf of the third-party RU.

The user RU is informed if the wagon number is not found in the GCU database.

The performance message should be sent electronically in XML¹ or CSV format² in accordance with the description hereafter. The keeper must be sent a separate performance message for every custody period.

To correct any erroneous performance data within a message, the RU should send an identical dataset with a negative mileage that cancels out the erroneous dataset. A new, correct dataset is also to be sent if required.

The GCU Bureau provides a communication platform (GCU Broker) to the signatories for transmission of the Wagon Performance Message.

¹ The XSD diagram and sample files are available to download from the GCU website.

² CSV files can be produced and read using (for example) MS Excel

Wagon Performance Message in CSV format with 5 sample data records

WagonNumberFreight	UserRU	PeriodStart	PeriodEnd	Country	Kilometers	TotalLoadWeight
338078605601	2887	29.10.2016 09:00	29.10.2016 12:01	DE	124	64200
338078605601	2887	29.10.2016 12:01	30.10.2016 08:24	AT	354	0
338078605601	2887	31.10.2016 12:25	01.11.2016 13:10		355	58000
338078605601	2887	29.10.2016 12:01	31.10.2016 08:24		634	50000
338078134636	1234	29.10.2016 12:01	31.10.2016 08:24	AT	734	58230

Performance message with a correction posted for the last dataset in the report above

WagonNumberFreight	User RU	Period Start	Period End	Country	Kilometers	TotalLoadWeight
338078134636	1234	29.10.2016 12:01	31.10.2016 08:24	AT	-734	58230
338078134636	1234	29.10.2016 12:01	31.10.2016 08:24	DE	634	58230

Remarks

- A semi-colon (“;”) is to be used as the separating character for CSV files.
- The header must be included in the file.
- If the times for PeriodStart and PeriodEnd are unknown, “00:00” is to be used (“DD.MM.YYYY 00:00”).
- A CSV sample file and template are available to download from the GCU website.

Description of wagon performance message (WPM) elements in CSV format

Element	Status	Definition
WagonNumberFreight	Mandatory	Full 12-position wagon number, including check digit, without spaces or hyphens. Example: 338078605601
User RU	Mandatory	4-position numerical company code of the user RU.
PeriodStart	Mandatory	Starting date and time of the wagon performance message (beginning of custody period). Format: dd.mm.yyyy hh:mm
PeriodEnd	Mandatory	End date and time of the wagon performance message (end of custody period). Format: dd.mm.yyyy hh:mm
Country	Conditional ³	Identification of the country where the wagon performance was executed using the 2-position alphanumerical country code in accordance with ISO 3166-1. Example: FR
Kilometers	Mandatory	Actual kilometric performance of the wagon for the period specified (start date to end date). Kilometric performances within a station due to, for example, shunting movements for the purpose of loading/unloading or train formation can be disregarded. Tariff kilometres, estimations or timetabled kilometres are not sufficient to meet this requirement. Example: 423 (without decimal place)
TotalLoadWeight	Mandatory	Payload (net tonnage), including container, in kg. Empty = 0 kg Example: 55400 (without decimal place)

³ Obligatory in Germany under the “Noise Bonus” system. Performance data for cross-border traffic must be submitted separately by country within a single custody period.

APPENDIX 16
TO THE GENERAL CONTRACT OF USE FOR WAGONS

TECHNICAL WAGON DATA

Appendix 16 describes in more detail the information-related requirements laid out in article 7.4.

In accordance with pages 5-8, the keeper must provide the administrative and technical vehicle data for all wagons registered in the GCU database as soon as possible prior to the use of a wagon. The RU has access to this data at all times and may use it for its own operational purposes only.

The GCU Bureau provides a communication platform (GCU Broker) to the signatories for transmission of technical vehicle data.

Additional information - for example, a brief description of any instructions destined for technical inspectors and operational staff - must be made available bilaterally. Information is always required if vehicle-related technical matters are not provided for in Appendix 9 to the GCU.

Description of elements of technical wagon data

Element	Type	Definition
WagonNumber-Freight	Mandatory	Identifies uniquely the freight wagon by its number
PreviousWagon-Number-Freight	Optional	For identification of a wagon after renumbering
Registration-Country	Mandatory	ISO country code of registration country
DatePutIntoService	Mandatory	Date of first operation
AuthorisationValid Until	Conditional	End date for restricted authorisation (applicable only in special cases)
SuspensionOf-Authorisation	Conditional	Information if authorisation has been suspended by the authority
DateSuspensionOf Authorisation	Conditional	Date of the suspension of authorisation; must be provided in case of suspension
Multilateral-Authorisation-Countries	Conditional	List of countries/railway letter codes where a wagon with a limited interoperable authorisation is allowed to be operated (derogation plate); first entry is the authorising country/railway and following entries are the accepting countries/railways
ChannelTunnel-Permitted	Optional	Indication if wagon is allowed to pass the Channel Tunnel - if the transport is planned between UK and France and should use Eurotunnel infrastructure
QuieterRoutes-Exemption-Country	Conditional	ISO code of country where the wagon has an exemption in accordance with TSI Noise to run on quieter routes although it is not TSI Noise compliant.
KeeperShortName VKM	Mandatory	Vehicle Keeper Marking of the wagon keeper as listed in VKM register (http://www.era.europa.eu/Document-Register/Pages/list-VKM.aspx , column B - without special characters)
ECM	Mandatory	Full name of the assigned Entity in Charge of Maintenance
PlannedChangeOf ECM	Conditional	Date until the current Entity in Charge of Maintenance is assigned to the wagon and full name of the following Entity in Charge of Maintenance
ECMCertificate	Mandatory	ECM certificate information
InteropCapability	Mandatory	Identification of the general interoperability capability of the wagon.
GCUWagon	Mandatory	Indication if wagon is operated under the GCU contract
LetterMarking	Mandatory	Complete wagon category letter code. The Identification marking for freight rolling stock (wagon type) is defined in the Uniform Technical Prescription applicable to Vehicle Numbers and linked alphabetical marking on the bodywork: The Railway Vehicle Marking (UTP Marking), issued by the OTIF.
TankCode	Conditional	Tank code (applies only for tank wagons). The codes are defined in the RID regulation, chapter 4.3.3 and 4.3.4.1.1
WagonNumberOf-Axles	Mandatory	Number of Axles for a wagon
WheelSetType	Optional	Type name of the wheel sets, and the name of the type depends on the manufacturer.
WheelDiameter	Optional	Diameter of wheels measured in mm. Reference wheel diameter at maximum.

Element	Type	Definition
WheelsetGauge	Mandatory	Track Gauge measured in mm; multi-entry for wagons with changeable wheel set gauge
WheelSet-Transformation-Method	Conditional	Description of the wheel set transformation method for wagons with a changeable wheel set gauge.
NumberOfBogies	Conditional	Number of bogies.
BogiePitch	Conditional	Bogie Wheelbase measured in mm.
BogiePivotPitch	Conditional	Largest distance between two adjacent bogie pitches in mm.
InnerWheelbase	Mandatory	Maximum distance between two adjacent axles in mm
CouplingType	Optional	Classification of coupling.
BufferType	Optional	Classification of buffer. The following values are mostly used in the sector: A, AX, B, C, CX, L0 (130), L0 (150), L2 (130), L2 (150), L4 (130), L4 (150)
NormalLoading-Gauge	Conditional	Indicates the wagon loading gauge. When the wagon loading gauge is marked on the wagon the information must be provided in the RSRD message. Codes are defined in UIC leaflet 505-1/503 and EN 15273-2:2013 Code list.
MinCurveRadius	Mandatory	Minimum allowed curve radius of the wagon. Measured in Metres.
MinVerticalRadius YardHump	Mandatory	Minimum allowed vertical radius over yard humps. Measured in Meters.
WagonWeight-Empty	Mandatory	The weight of an empty wagon according to the entry in the rolling stock database. Measured in kg.
LengthOverBuffers	Mandatory	Length over buffers is expressed in cm.
MaxAxleWeight	Mandatory	Indicates the maximum design axle weight (to).
LoadTable	Mandatory	Indicates the load tables marked on the wagon. When load tables are marked on the wagon the information must be provided in the RSRD message. Several load tables (international, product specific for LPG wagons and additional/country specific) can be specified by providing the element several times consecutively. For special wagons with specific load tables (e.g. heavy haul wagons) no load table need to be provided. The complete load table must be provided including the empty load row (if existent).
NumberOfBrakes	Mandatory	Number of air brake control valves.
BrakeSystem	Optional	Abbreviation of air brake system. Following values are examples: Kk; Dr; Bo; Hik; Bd; Ch; O; KE; WE; DK; WU; WA; DM; MH, SW; KE 435; through brake pipe
AirBrakeType	Mandatory	Classification of air brake.
BrakingPower-VariationDevice	Mandatory	Type of braking power variation device.
AirBrakedMass	Mandatory	Different uses depending on air brake variation device: No variation device = sole braked mass of wagon Brake device with changeover weights = braked mass empty Brake with auto continuous device = maximum braked mass
ChangeOver-Weight	Conditional	Change over weight of braked weight in tonnes variation device.
AirBrakedMass-Loaded	Conditional	Braked weight in tonnes loaded for change over weight.
BrakeSpecial-Characteristics	Mandatory	General brake characteristics. Code list refers to UIC leaflet 920-13.
HandBrakeType	Mandatory	Classification of hand brake.

Element	Type	Definition
HandBraked-Weight	Conditional	Braked weight of the hand brake in tons.
ParkingBrakeForce	Conditional	Braked weight of the hand brake in kN.
BrakeBlockName	Optional	Name of the brake block type, including the length in mm.
CompositeBrake-BlockRetrofitted	Conditional	Indication if composite brake blocks are retrofitted or originally equipped.
CompositeBrake-BlockInstallation-Date	Conditional	Date of composite brake block installation, for originally equipped wagon = date put into service.
MaxLengthOfLoad	Optional	Loading length in mm for flat wagons and covered wagons with a flat floor, minus the thickness of any intermediate partitions (useful length).
LoadArea	Optional	Surface area in m ² of the floor of covered wagons and wagons with an opening roof and flat floor.
HeightOfLoading-PlaneUnladen	Optional	Height of the loading plane when wagon is empty measured in mm.
RemovableAccessories	Optional	The type and number of removable accessories are to be indicated.
LoadingCapacity	Mandatory	Usable Cube - measured in M3.
MaxGrossWeight	Mandatory	Weight of max Gross Load Weight plus the tare weight of the equipment.
VapourReturn-System	Optional	Indication if tank wagon is equipped with a vapour return system.
FerryPermittedFlag	Optional	Indication whether the wagon may be used on ferries between Great Britain and Continental Europe.
FerryRampAngle	Conditional	Maximum allowed angle of the ferry ramp (in grades: °).
Temperature-Range	Optional	Allowed environmental temperature range.
Technical-Forwarding-Restrictions	Conditional	This element is designed to identify any special aspects or restrictions which might be relevant to wagon handling operations in train formation yards or in trains because of technical feature of the wagon or its load. All codes of transport restrictions for Freight Traffic (cf. UIC 920-13) and Passengers Traffic are in the same list which is contained in the code list RestrictionCodes. In this element only those codes are used, that have "T - Technical" characteristics and "F - Freight" as type.
DateLastOverhaul	Mandatory	Date of the last overhaul. For wagons newly placed on the market, date put into service shall be used.
OverhaulValidity-Period	Conditional	Validity period of last overhaul in years as marked on the wagon. At least "OverhaulValidityPeriod" or "PlannedDateNextOverhaul" shall be provided.
Permitted-Tolerance	Mandatory	Permitted tolerance after date of overhaul (in months). In case no tolerance is allowed, value shall be "0".
PlannedDate-NextOverhaul	Conditional	Date of planned next overhaul. It must be within the validity period of the last overhaul. The element serves as indication of the actually planned date of next overhaul by the wagon keeper/ECM. At least "OverhaulValidityPeriod" or "PlannedDateNextOverhaul" shall be provided.
DateOfNextTank-Inspection	Conditional	Date of the next tank inspection applies only for tank wagons.

Remarks

Values and codes list for the different data elements are part of the XSD schema and referenced in the GCU Broker website. The XSD schema and sample files are available to download from the GCU Broker website.